

DC - Представитель и Дистрибьютер :

DC - Przedstawiciel i Dystrybutor :



DC SWISS SA

CH-2735 Malleray
Tel. +41 32 491 63 63
Fax +41 32 491 64 64
E-mail: info@dcswiss.ch



**THREADING
TECHNOLOGY**

www.dcswiss.com

DC SWISS SA
RU-PL-ID-2014



**THREADING
TECHNOLOGY**

www.dcswiss.com

Основной каталог
Katalog główny
RU-PL-ID-2014



**THREADING
TECHNOLOGY**



Наличие инструмента на складе

- ID** *Идентификационный номер, в наличии на складе*
- * ID** *Идентификационный номер, поставляется пока есть на складе*

Dostępność artykułów

- ID** Numer identyfikacyjny, dostępny z magazynu DC
- * ID** Numer identyfikacyjny, dostępny z magazynu, do wyczerpania zapasów

The management system of

DC Swiss SA

Grand rue 19 CP 363
2735 Malleray, Switzerland



has been assessed and certified as meeting the requirements of

ISO 9001:2008

For the following activities

**Cutting tool designer and manufacturer,
expert in Threading Technology.**

This certificate is valid from 7 September 2013 until 6 September 2016
and remains valid subject to satisfactory surveillance audits
Recertification audit due before 25 August 2016
Issue 4. Certified since September 2007

Authorised by





Accréditation N° SCESm 017

SGS Société Générale de Surveillance SA Systems & Services Certification
Technoparkstrasse 1 8005 Zurich Switzerland
t +41 (0)44 445-16-80 f +41 (0)44 445-16-88 www.sgs.com



K







 **VS**  **EL**
K613VS-3 **M**

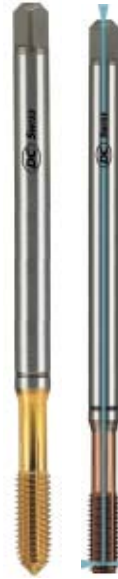

 **TiCN**
K313TC-3
K413TC-3 **MF**



FPS-FAS



 **VS** 
FPS581VS-3 **M**
FPS681VS-3

 **VS**  
FPS584VS-3 **M**
FPS684VS-3

 **VS** 
FAS581VS-3 **M**
FAS681VS-3

 **VS**  
FAS584VS-3 **M**
FAS684VS-3

W









 **DL**
W320DL-4 **M**
W420DL-4

 **R40**  **DL**
W360DL-3 **M**
W460DL-3 **G**
W460DL-5

FS







  **DL**  **E** 1.5 x P
FS380DL-5 **M**

  **DL**  **C** 2.5 x P
FS380DL-3 **M**

GW



 **2.5 x D_i**  **VS**
GW3016 \leq **M12**
GW3016VS **MF**

 **4 x D_i**  **VS**
GW3019 \leq $\frac{1}{2}$ **UNC**
GW3019VS \leq $\frac{3}{8}$ **UNF**

AERO



SA320-4 **UNJF 3B**

N Schaublin



N1110-3 **SV**
N1210-3
N5120



NEW

КОДИРОВКА – KODYFIKACJA

DC Метчики

DC Gwintowniki

Пример - Przykład



Нормальные материалы	Materiały normalne	N							
Мягкие материалы	Materiały miękkie	W							
Вязкие материалы	Materiały trudnoobrabialne	Z							
Материалы с высоким пределом прочности	Materiały utwardzone	H							
Специальные сплавы	Stopy specjalne	S							
Специальные сплавы (Аэро)	Stopy specjalne - przemysł lotniczy	SA							
Титановые сплавы (Аэро)	Stopy tytanu - przemysł lotniczy	TL							
Чугун и алюминиевое литье	Żeliwo i aluminium	GG							
Скоростное нарезание резьбы	Gwintowanie na sztywno	RTS							
Серия «К» для глубоких резьб	Łamacz wióra	K							
Метчики МЕГА	Gwintowniki typ MEGA	MA							
Специальное исполнение	Specjalne wykonanie		3						
Короткий усиленный хвостовик по DIN	DIN krótki - chwyt wzmocniony			1					
Короткий утонченный хвостовик по DIN	DIN krótki - chwyt przelotowy			2					
Длинный усиленный хвостовик по DIN	DIN długi - chwyt wzmocniony			3					
Длинный утонченный хвостовик по DIN	DIN długi - chwyt przelotowy			4					
Сверхдлинный усиленный хвостовик по DIN	DIN extra-długi - chwyt wzmocniony			5					
Сверхдлинный утонченный хвостовик по DIN	DIN extra-długi - chwyt przelotowy			6					
Стандарт DC	standardy DC			9					
Короткий усиленный хвостовик по ISO	ISO krótki - chwyt wzmocniony			11					
Короткий утонченный хвостовик по ISO	ISO krótki - chwyt przelotowy			12					
Прямые канавки	Proste rowki wiórowe			1					
Прямые канавки с подточкой центра	Proste rowki wiórowe, skośna powierzchnia natarcia			2					
Подточка центра	Skośna powierzchnia natarcia			3					
Левые спиральные канавки <27°	< 27° rowki wiórowe lewoskrętne			4					
Правые спиральные канавки <27°	< 27° rowki wiórowe prawoskrętne			5					
Правые спиральные канавки >27°	> 27° rowki wiórowe prawoskrętne			6					
Правые спиральные канавки >40°	> 40° rowki wiórowe prawoskrętne			7					
10° правые спиральные канавки, подточка центра	10° rowki wiórowe prawoskrętne, skośna powierzchnia natarcia			9					
Стандартный	Standard						0		
Шахматный метчик	Nakrój przerywany						1		
С увеличенным стружечным пространством	Nakrój obniżony						2		
Внутренний подвод охлаждающей жидкости	Chłodzenie wewnętrzne						3		
Шахматный метчик с внутренним подводом СОЖ	Nakrój przerywany, chłodzenie wewnętrzne						4		
Сув. стружечным пространством и подводом сож	Nakrój obniżony, chłodzenie wewnętrzne						5		
Обработка поверхности „V”	Waporyzacja „V”							V	
Износостойкое покрытие	Powłoka zabezpieczająca przed zużyciem							VS	
Покрытие нитридом титана (TiN)	Powłoka „TiN”							TN	
Покрытие карбонитридом титана (TiCN)	Powłoka „TiCN”							TC	
Плазменное азотирование «N» обработка поверхности	Azotowany + waporyzowany							NV	
Покрытие DLC	Powłoka „DLC”							DL	
Покрытие HADRDLUBE	Powłoka „Hardlube”							HL	
Предварительный метчик	Gwintownik nr 1 - wstępny								=1
Второй метчик	Gwintownik nr 2 - zgrubny								=2
Чистовой метчик (заходная часть 2-3 нитки)	Gwintownik nr 3 - wykańczający (2- 3 zwojów wprowadzających)								=3
Заходная часть 3.5-5 ниток, подточка центра	3.5- 5 zwojów wprowadzających, skośna powierzchnia natarcia								=4
Заходная часть 1.5-2 нитки	1.5- 2 zwojów wprowadzających								=5
Заходная часть 6-8 ниток	6- 8 zwojów wprowadzających								=8
Комплектные метчики	Zestaw gwintowników								=S

КОДИРОВКА – KODYFIKACJA

DC Раскатники

DC Wygniataki

Пример - Przykład



Форма стандартного полигона $\lt; \varnothing 3\text{мм}$	Geometria standardowa $\lt; \varnothing 3\text{мм}$	FS							
Форма пассивного полигона >math>\ge \varnothing 3\text{мм}</math>	Geometria pasywna >math>\ge \varnothing 3\text{мм}</math>	FPS							
Форма активного полигона >math>\ge \varnothing 3\text{мм}</math>	Geometria aktywna >math>\ge \varnothing 3\text{мм}</math>	FAS							
Специальное исполнение	Wykonanie specjalne		3						
Усиленный хвостовик по DIN	DIN długi - chwyt wzmożniony		3						
Утонченный хвостовик по DIN	DIN długi - chwyt przelotowy		4						
Сверхдлинный усиленный хвостовик по DIN	DIN extra-długi - chwyt wzmożniony		5						
Сверхдлинный утонченный хвостовик по DIN	DIN extra-długi - chwyt przelotowy		6						
Раскатник	Wygniatak			8					
Без канавок для подвода СОЖ	Bez rowków smarnych					0			
С канавками для подвода СОЖ	Z rowkami smarnymi					1			
Внутренний подвод СОЖ с радиальным выходом	Chłodzenie wewnętrzne z ujęciem promieniowym					4			
Износостойкое покрытие	Powłoka zabezpieczająca przed zużyciem							VS	
Покрытие нитридом хрома (CrN)	Powłoka „CrN”							CN	
Покрытие DLC	Powłoka „DLC”							DL	
Заходная часть 2-3 нитки	2 - 3 zwojów wprowadzających								-3
Заходная часть 1,5-2 нитки	1.5 - 2 zwojów wprowadzających								-5

ПИКТОГРАММЫ – PIKTOGRAMY

	Усиленный хвостовик по DIN 371 Chwyt wzmożniony wg DIN 371		Раскатник Wygniatak
	Утонченный хвостовик по DIN 376 Chwyt przelotowy wg DIN 376		Раскатник с канавками подвода СОЖ Wygniatak z rowkami smarnymi
	Быстрорежущая сталь с кобальтом HSSE Stal kobaltowa HSSE		Предварительный метчик Gwintownik nr 1 - wstępny
	Порошковая быстрорежущая сталь HSSE-PM Stal proszkowa ASP		Второй метчик Gwintownik nr 2 - zgrubny
	Количество режущих кромок (Z) Ilość ostrzy (Z)		Чистовой метчик Gwintownik nr 3 - wykańczający
	Прямые канавки Proste rowki wiórowe		Ручные метчики, компл. из 2шт. Gwintowniki ręczne, zestaw 2 szt.
	Прямые канавки с подточкой центра Proste rowki wiórowe, skośna powierzchnia natarcia		Ручные метчики, комплект из 3-х шт. Gwintowniki ręczne, zestaw 3 szt.
	Подточка центра Skośna powierzchnia natarcia		Метчик с цапфой Pilot
	Правые спиральные канавки 40° 40° rowki wiórowe prawoskrętne		Внутренний подвод СОЖ с фронтальным выходом Chłodzenie wewnętrzne z ujęciem poosiowym
	С увеличенным стружечным пространством Nakrój obniżony		Внутренний подвод СОЖ с радиальным выходом Chłodzenie wewnętrzne z ujęciem promieniowym
	Шахматный метчик Nakrój przerywany		

ПИКТОГРАММЫ – PIKTOGRAMY



Для групп материалов согласно таблице

Dla grup materiałowych wg „Tabeli Zastosowań” Swiss

12
1.0037 S137-2 (S235JR)
1.0050 S150-2 (E295)
1.0060 S160-2 (E335)
1.5919 15CrNi6
1.7131 16MnCr5

22
1.4301 X5CrNi18-10
1.4406 X2CrNiMo17-12-2
1.4435 X2CrNiMo18-14-3
1.4541 X6CrNiTi18-10
1.4571 X6CrNiMoTi17-12-2



Сверхдлинный
Extra-długi



Сквозные отверстия, длинностружечные материалы
Otwór przelotowy, materiały z długim wiórem



Сквозные отверстия <1,5xD, короткостружечные материалы
Otwór przelotowy < 1.5 x D, materiały z krótkim wiórem



Глухие отверстия <1,5xD, длинностружечные материалы
Otwór ślepy < 1.5 x D, materiały z długim wiórem



Глухие отверстия <2,5xD, длинностружечные материалы
Otwór ślepy < 2.5 x D, materiały z krótkim wiórem



Сквозные/глухие отверстия >2,5xD
Otwór przelotowy/ślepy > 2.5 x D



Глухие отверстия <3xD
Otwór ślepy < 3 x D



MEGA резьбонарезная головка
Główka nasadzana, gwintująca MEGA



Корончатый метчик
Gwintownik koronowy



Комбинированный сверло/метчик
Wiertło - gwintownik



Диаметр отверстия под резьбу
Średnica otworu



Радиус на наружном диаметре
Promień na zewnętrznej średnicy



Коническая резьба 1:16 (NPT - NPTF - Rc)
Gwint stożkowy 1:16 (NPT - NPTF - Rc)



Резьба EG
Gwint EG



Левая резьба
Gwint lewy



Заходная часть 3.5-5 нитки, форма B
3.5 - 5 zwojów wprowadzających, forma B



Заходная часть 2-3 нитки, форма C
2-3 zwojów wprowadzających, forma C



Заходная часть 1.5-2 нитки, форма E
1.5 - 2 zwojów wprowadzających, forma E



Класс точности ISO 2 6H
Tolerancja ISO 2 6H



Класс точности ISO 2 6H + 0.1 mm
Klasa tolerancji ISO 6H +0.1 mm



Класс точности ISO 3 6G
Klasa tolerancji ISO 3 6G



Обработка поверхности „V”
 Waporyzacja „V”



Износостойкое покрытие
 Powłoka zabezpieczająca przed zużyciem



Покрытие нитридом титана
Powłoka „TiN”



Покрытие карбонитридом титана
Powłoka „TiCN”



Плазменное азотирование «+V» обработка поверхности
Azotowany + waporyzowany



Покрытие нитридом хрома
Powłoka „CrN”



Покрытие DLC
Powłoka „DLC”



Покрытие HADRDLUBE
Powłoka „Hardlube”



Элементная стружка
Fragmenty wiórow



Для классического нарезания резьбы
Do gwintowania standardowego



Для скоростного нарезания
Do gwintowania na sztywno

ГРУППЫ ПРИМЕНЯЕМОСТИ

Примеры для групп применяемости

11 Автоматные стали 1.0711 9S20 1.0715 9SMn28 1.0718 9SMnPb28 1.0726 35S20 1.0737 9SMnPb36	12 Структурные/цементуемые стали 1.0037 Si37-2 (S235JR) 1.0050 Si50-2 (E295) 1.0060 Si60-2 (E335) 1.5919 15CrNi6 1.7131 16MnCr5	13 Углеродистые стали 1.0503 C45 1.0535 C55 1.0601 C60 1.1545 C105W1 1.2067 102Cr6 (100Cr6)	14 Легированные стали <850 N/mm ² 1.2363 X100CrMoV5-1 1.3551 80MoCrV42-16 1.7218 25CrMo4 1.7220 34CrMo4 1.7225 42CrMo4	15 Легированные стали <850 - <1150 N/mm ² 1.3553 X82WMoCrV6-5-4 1.6580 30CrNiMo8 1.7220 34CrMo4 1.7225 42CrMo4v 1.8507 34CrAlMo5	16 Высокопрочные легированные стали EN-GJS-1200-2 1.6582 34CrNiMo6v 1.7225 42CrMo4v 1.7228 50CrMo4v 1.8515 31CrMo12v	21 Легкообрабатываемые нержавеющие стали 1.4005 X12CrS13 1.4104 X14CrMoS17 1.4305 X10CrNiS18-9	22 Аустенитные нержавеющие стали 1.4301 X5CrNi18-10 1.4406 X2CrNiMoN17-12-2 1.4435 X2CrNiMo18-14-3 1.4541 X6CrNiTi18-10 1.4571 X6CrNiMoTi17-12-2	23 Ферритные и мартенситные <850 N/mm ² 1.4112 X90CrMoV18 1.4540 X4CrNiCuNb16-4 1.4582 X4CrNiMoNb25-7 1.4762 X10CrAl24 1.4922 X20CrMo11-1	24 Ферритные и мартенситные >850 - <1150 N/mm ² 1.4057 X17CrNi17-2 1.4125 X105CrMo17 1.4542 X5CrNiCuNb16-4 1.4548 X5CrNiCuNb17-4-4 1.4748 X85CrMoV18-2	31 Чугун 0.6015 GG15 0.6020 GG20 0.6025 GG25 0.6030 GG30	32 Ковкий и высокопрочный чугун 0.7040 GGG40 0.7043 GGG40.3 0.7050 GGG50 0.7060 GGG60 0.7080 GGG80	41 Чистый титан 3.7024 Grad1 3.7034 Grad2 3.7055 Grad3 3.7065 Grad4	42 Титановые сплавы 3.7124 TiCu2.5 Ti6Al7Nb 3.7164 TiAl6V4 (Grad5) 3.7174 TiAl6V6Sn2	51 Никелевые сплавы 1 <850 N/mm ² 1.3912 Ni36 (Invar) 2.4360 NiCu30Fe (Monel 400) 2.4816 NiCr15Fe (Inconel 600) 1.4876 X10NiCrAlTi32-20	52 Никелевые сплавы 2 >850 - <1150 N/mm ² 2.4375 NiCu30Al (MonelK500) 2.4631 NiCr20TiAl (Nimonic 80) 2.4668 NiCr19NbMo (Inconel718)	53 Никелевые сплавы 3 >1150 - ≤1600 N/mm ² 2.4631 NiCr20TiAl (Nimonic80) 2.4668 NiCr19NbMo (Inconel718)	61 Чистая медь (электротехническая) 2.0060 E-Cu57 (E-Cu)	62 Короткостружечная латунь 2.0401 CuZn39Pb3 (Ms58) 2.0402 CuZn40Pb2 (Ms58) 2.1030 CuSn8 (Bz) 2.1096 G-CuSn5ZnPb	63 Длинностружечная латунь 2.0240 CuZn15 (Ms85) 2.0265 CuZn30 (Ms70) 2.0321 CuZn37 (Ms63)	71 Нелегированный алюминий 3.0205 Al99 3.0255 Al99.5	72 Алюминий, Si < 1.5% 3.1255 AlCuSiMn 3.1355 AlCuMg2 3.2315 AlMgSi1 3.3206 AlMgSi0.5 3.4345 AlZnMgCu0.5	73 Алюминий, Si > 1.5% - < ≈10% 3.2161 G-AlSi8Cu3 3.2162 GD-AlSi8Cu3 3.2341 G-AlSi5Mg 3.2371 G-AlSi7Mg	74 Алюминий, Si >10%, сплавы магния 3.2381 G-AlSi10Mg 3.2382 GD-AlSi10Mg 3.2581 G-AlSi12 3.2583 G-AlSi12 (Cu)
81 Термопластики Delrin (POM) Teflon Nylon	82 Дуропластики Bakelit Novopan	83 Стеклопластики Стеклопластики Термо- и Дуропластики	Стандарт: DIN																				

GRUPY ZASTOSOWAŃ

Przykłady dla grup zastosowań

11 Stale szybko tnące 1.0711 1212 1.0715 1213 1.0718 12L13 1.0726 1140 1.0737 12L14	12 Stale konstrukcyjne/nawęglane 1.0037 1015 1.0050 A570 Gr.50 1.0060 A572 Gr.65 1.5919 3115 1.7131 5115	13 Stale węglowe 1.0503 1045 1.0535 1055 1.0601 1060 1.1545 W110 1.2067 L 3	14 Stale stopowe <850 N/mm ² 1.2363 A2 1.3551 M50 1.7218 4130 1.7220 4135 1.7225 4140	15 Stale stopowe >850 - <1150 N/mm ² 1.3553 - 1.6580 4340 1.7220 4135 1.7225 4140 1.8507 A355CLD (K23510)	16 Stale stopowe o dużej wytrzymałości EN-GJS-1200-2 1.6582 4340 1.7225 4140 1.7228 4150 1.8515 -	21 Stale automatowe nierdzewne 1.4005 416 1.4104 430F 1.4305 303	22 Austeniczne stale nierdzewne 1.4301 304 1.4406 316LN 1.4435 316L 1.4541 321 1.4571 316Ti	23 Stale ferrytyczne i martenzytyczne <850 N/mm ² 1.4112 440B 1.4540 XM12 (15-5PH) 1.4582 - 1.4762 446 1.4821 4922	24 Stale ferrytyczne i martenzytyczne >850 - <1150 N/mm ² 1.4057 431 1.4125 440C 1.4542 630 (17-4PH) 1.4748 -	31 Żeliwo szare 0.6015 A48-25B 0.6020 A48-30B 0.6025 A48-40B 0.6030 A48-45B	32 Żeliwo sferoidalne 0.7040 60-40-18 0.7043 - 0.7050 65-45-12 0.7060 80-55-06 0.7080 120-90-02	41 Czysty tytan 3.7024 Gr.1 3.7034 Gr.2 3.7055 Gr.3 3.7065 Gr.4	42 Stopy tytanu 3.7124 Alloy 230 F-1295 3.7164 Gr.5 3.7174 -	51 Stopy niklu 1 <850 N/mm ² 1.3912 K93600 2.4360 N04400 1.4816 N08800	52 Stopy niklu 2 >850 - <1150 N/mm ² 2.4375 N05500 (B865) 2.4631 N07080 (B637) 2.4668 N07718 (B637)	53 Stopy niklu 3 >1150 - ≤1600 N/mm ² 2.4631 N07080 (B637) 2.4668 N07718 (B637)	61 Czysta miedź (miedź elektrolityczna) 2.0060 C11000	62 Mosiądz z krótkim wiórem, brąz fosforowy, brąz armatni 2.0401 C38500 2.0402 C37800 2.1030 C52100 2.1096 -	63 Mosiądz z długim wiórem 2.0240 C23000 2.0265 C26000 2.0321 C27200	71 Aluminium niestopowe 3.0205 1200 3.0255 1050A	72 Stopy aluminium, Si < 1.5% 3.1255 2014 3.1355 2024 3.2315 6082 3.3206 6060 3.4345 7020	73 Stopy aluminium, Si > 1.5% - < 10% 3.2161 380.1 3.2162 - 3.2341 - 3.2371 A 356.2	74 Stopy aluminium, Si > 10%, Stopy magnezu 3.2381 A360 3.2382 - 3.2581 A413 3.2583 413.1	81 Tworzywa sztuczne - termoplasty Delrin (POM) Teflon Nylon	82 Tworzywa sztuczne - duroplasty Bakelit Novopan	83 Tworzywa sztuczne wzmacniane włóknem szklanym Duro i Termoplasty wzmacniane włóknem szklanym
			Odniesienie: AISI/ASTM/UNS																							

ТАБЛИЦА ПРИМЕНЕНИЯ – TABELA ZASTOSOWAŃ

НАРЕЗАНИЕ РЕЗЬБЫ – GWINTOWANIE

Нарезание резьбы Nacinięcie gwintu

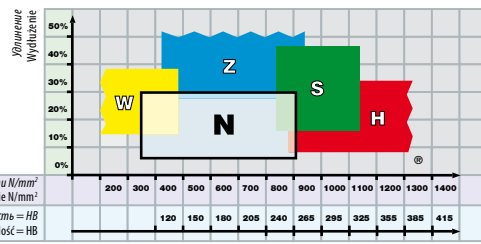

Нарезание резьбы Nacinięcie gwintu

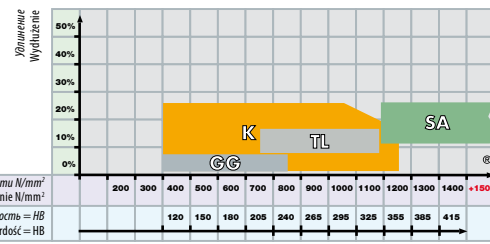

Скоростное нарезание резьбы Gwintowanie na szywno

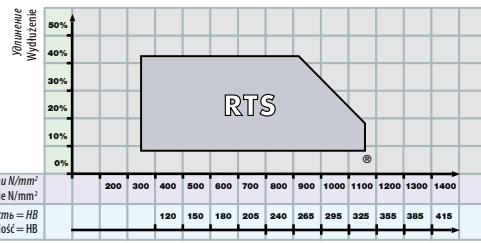

Формирование раскатниками Wygniatanie gwintu

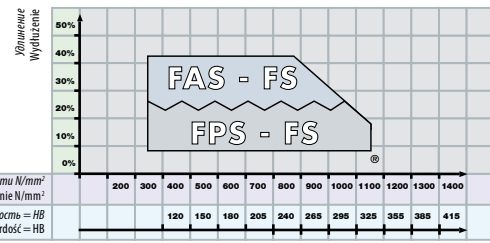

Классификация материалов Klasyfikacja materiału

Группы материалов Grupy materiałowe	Описание материалов	Оznaczenie materiału	Твердость Twardość (HB)	Предел прочности Wytrzymałość na rozciąganie Rm (N/mm²)	Удлинение Wydluzenie A (%)
10 Стале Stale	11 Автоматные стали	Stale szybko tocące	< 200	< 700	< 10
	12 Структурные/цементуемые стали	Stale konstrukcyjne/nawęglane	< 200	< 700	< 30
	13 Углеродистые стали	Stale węglowe	< 300	< 1000	< 20
	14 Легированные <850 N/mm²	Stale stopowe <850 N/mm²	< 250	< 850	< 30
	15 Легированные стали >850 - <1150 N/mm²	Stale stopowe >850 - <1150 N/mm²	> 250	> 850	< 30
	16 Высокопрочные легированные стали	Stale stopowe o dużej wytrzymałości	> 250	> 850	< 12
20 Нержавеющие стали Stale nierdzewne	21 Легкообрабатываемые нержавеющие стали	Stale automatowe nierdzewne	< 250	< 850	< 25
	22 Аустенитные нержавеющие стали	Austeniczne stale nierdzewne	< 250	< 850	> 20
	23 Ферритные и мартенситные <850 N/mm²	Stale ferrytyczne i martenzytyczne <850 N/mm²	< 250	< 850	> 20
	24 Ферритные и мартенситные >850 - <1150 N/mm²	Stale ferrytyczne i martenzytyczne >850 - <1150 N/mm²	> 250	> 850	> 15
30 Чугун Żeliwo szare	31 Чугун	Żeliwo szare	< 250	< 850	< 10
	32 Ковкий и высокопрочный чугун	Żeliwo sferoidalne	< 250	< 850	> 10
40 Титан Tytan	41 Чистый титан	Czysty tytan	< 250	< 850	> 20
	42 Титановые сплавы	Stopy tytanu	> 250	> 850	< 20
50 Никель Nikiel	51 Никелевые сплавы 1 <850 N/mm²	Stopy niklu 1 <850 N/mm²	< 250	< 850	> 25
	52 Никелевые сплавы 2 >850 - <1150 N/mm²	Stopy niklu 2 >850 - <1150 N/mm²	> 250	> 850	< 25
	53 Никелевые сплавы 3 >1150 - ≤1600 N/mm²	Stopy niklu 3 >1150 - ≤1600 N/mm²	> 340	> 1150	< 20
60 Медь Miedź	61 Чистая медь (электротехническая)	Czysta miedź (miedź elektrolityczna)	< 120	< 400	> 12
	62 Короткопружечная латунь	Mosiądz z krótkim wiórem, brąz fosforowy, brąz armatni	< 200	< 700	< 12
	63 Длиннопружечная латунь	Mosiądz z długim wiórem	< 200	< 700	> 12
70 Алюминий, Магний Aluminium, Magnez	71 Нелегированный алюминий	Aluminium niestopowe	< 100	< 350	> 15
	72 Алюминий Si < 1.5 %	Stopy aluminium, Si < 1.5 %	< 150	< 500	> 15
	73 Алюминий Si > 1.5 % - < 10 %	Stopy aluminium, Si > 1.5 % - < 10 %	< 120	< 400	< 15
	74 Алюминий Si > 10 %, сплавы магния	Stopy aluminium, Si > 10 %, Stopy magnezu	< 120	< 400	< 10
80 Сложные пластики, композиты Tworzywa sztuczne	81 Термопластики	Tworzywa sztuczne - termoplasty	-	-	-
	82 Дуропластики	Tworzywa sztuczne - duroplasty	-	-	-
	83 Стеклопластики	Tworzywa sztuczne wzmacniane włóknom szklanym	-	-	-

Со страницы :
Od strony :

M	22	22	24	24	24	32	32	34	34	34	34
MF	85	84	85	85		84		91	91	91	
UNC/UNC(J)	114	114	114					116	116		
UNF/UNF(J)	134	134	134					136	136		
UNEF/UN/UNS	150	150						151	151		
G/Rp/Rc	156	157	157	157				158	158	158	
W / SV	166	166									
NPT/NPTF	170										
PG/TR	172	172									
EG M/EG UNC/EG UNF	176	176						177	177		

N

Нормальные материалы
Materiały normalne

W



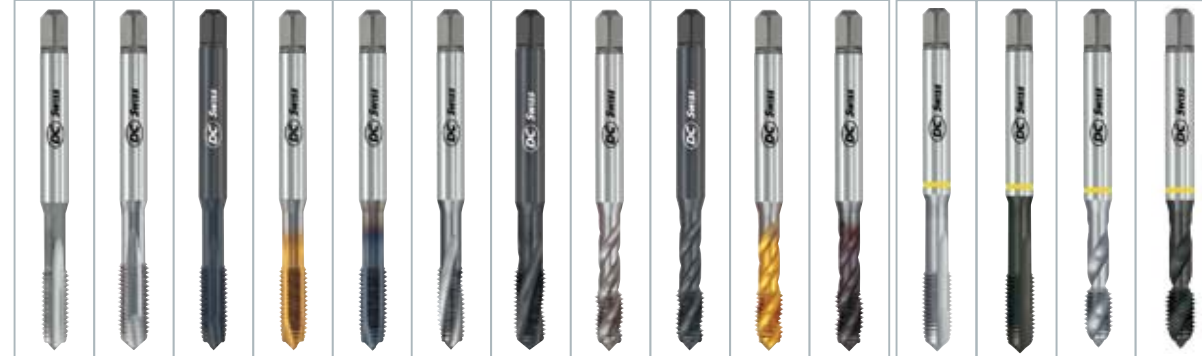



















Мягкие материалы
Materiały miękkie







Vc (m/min)	Vc (m/min)	
	< 20 mm	Общие указания Przewodnik
10-15	20-30	Standard +V / +NV
10-15	20-30	С покрытием Powlekany TN / TC / VS / DL
8-12	16-24	
8-12	16-24	
3-5	6-12	
3-5	3-5	
10-15	20-30	
2-6	6-12	
2-6	6-12	
	4-8	
10-15	20-30	
10-15	20-30	
4-8	4-8	
3-5	3-5	
3-5	6-12	
	4-8	
8-12	12-16	
20-30		
16-24		
10-15		
20-30	20-30	
10-15	20-30	
10-15	20-30	
20-30		
8-16	16-24	
4-8	8-16	

	M 10	M 20	M 20V	M 20TN	M 20TC	M 50	M 50V	M 60	M 60V	M 60TN	M 60TC	W 20	W 20DL	W 60	W 60DL
10	SB	SB	SE	SB	SE	SE	SE	SE	SE	SE	SE				
12	SB	SB	SE	SB	SE	SE	SE	SE	SE	SE	SE				
13	SE	SE	SE	SE	SE	SE	SE	SE	SE	SE	SE				
14	SE	SE	SE	SE	SE	SE	SE	SE	SE	SE	SE				
15															
16															
21		SE	E	SE	SE	SE	SE	SE	E	SE	SE				
22															
23															
24															
31	E			E	E					E	E				
32	SE	SE	SE	SE	SE	SE	SE	SE	SE	SE	SE				
41															
42															
51															
52															
53															
61	S					S		S				S	SE	S	SE
62	SE					SE		SE							
63	SE					SE		SE							
71	S					S		S				S	SE	S	SE
72	SE					SE		SE				SE	SE	SE	SE
73	E					E		E							
74	E					E		E							
81	E					E		E				E		E	
82															
83															

НАРЕЗАНИЕ РЕЗЬБЫ – GWINTOWANIE

Z Вязкие материалы Materiały trudnoobrabialne					H Материалы с высоким пределом прочности Materiały utwardzone				S Специальные сплавы Stopy specjalne		SA AERO TL Специальные сплавы Stopy specjalne - przemysł lotniczy			GG Чугун и алюминиевые лите Żelazo i aluminium		K				
48	48	49	50	50	52	52	54	54	56	57	58	58	57	58	60	60	66			
94	94	94	94		96		97		98	98	100	100	99	100			103			
118	118	119	120		121		121		122	123	124	124	125	124						
138		138	139		140		141		142	142	143	143	145	143						
								159												
160	160	160	161																	
				181					184	184	178	178	179	178						
																				
Z-20V	Z-20VS	Z-60V Z-62V	Z-70VS	Z-73VS	H-20	H-20TC	H-50	H-50TC	S-20VS	S-60VS	SA-20	SA-50	SA-90	TL-20VS	TL-51VS	GG-50NV	GG-50TC	GG-53TC	K-13TC	K-13VS
																				
			SE	SE	S	SE	S	SE	SE	SE	S	S							SE	SE
SE	SE	SE							S	S									SE	SE
S	SE	S	SE	SE					SE											
S	SE	S	SE	SE					SE											
	S		SE	SE		S		S	SE	SE										
						E		E								E	E		E	E
S														S						
S														SE						
S	SE	S	SE	SE					S	S	SE	SE								
			S	S							S	S	SE							
	SE		SE	SE																
					SE		SE												SE	SE
																			SE	SE
																E	E		E	E
					L	L	L	L												
						L		L												

 Оптимально с воздухом
 Допустимо с воздухом

 Optymalne z chłodzeniem powietrznym
 Możliwe z chłodzeniem powietrznym

 Ograniczone применение

 Ograniczone

СКОРОСТНОЕ НАРЕЗАНИЕ РЕЗЬБЫ С ЧПУ – GWINTOWANIE NA SZTYWNO

Со страницы
Od strony :

M
MF
UNC
UNF
UNEF/UN/UNS
G/Rp/Rc
NPT/NPTF
W
PG/TR/SV
EG M/EG UNC/EG UNF

K

66	67
103	



RTS

62	62	63	63	50	50
102		102		94	
126		126		120	
146		146		139	
		161		161	
				181	



Z

Vc (m/min)

Ø	Ø	Ø	Ø
M6-M10	M12-M16	M20-M30	M33-M42
32	28	22	18
30	25	20	15
24	20	16	12
24	20	16	12
15	12	8	6
30	25	20	15
30	25	20	15
35	30	25	20
32	28	22	18
30	25	20	15

K. 13TC	K. 13VS	
		11
		12
		13
		14
		15
		16
		21
		22
		23
		24
		31
		32
		41
		42
		51
		52
		53
		61
		62
		63
		71
		72
		73
		74
		81
		82
		83

Vc (m/min)
< Ø 20 mm
(Guide line)

Спокрытием VS
Powlekany VS

20 – 40
20 – 40
16 – 24
16 – 24
6 – 12
20 – 40
6 – 12
6 – 12
4 – 8
20 – 40
20 – 40
6 – 12
10 – 20
20 – 40
30 – 50
20 – 40
20 – 40

RTS-20VS	RTS-23VS	RTS-62VS	RTS-65VS	Z. 70VS	Z. 73VS	
						11
						12
						13
						14
						15
						16
						21
						22
						23
						24
						31
						32
						41
						42
						51
						52
						53
						61
						62
						63
						71
						72
						73
						74
						81
						82
						83

Оптимально с маслом
 Допустимо с маслом

Optymalne z chłodzeniem olejowym
 Możliwe z chłodzeniem olejowym

Оптимально с эмульсией
 Допустимо с эмульсией

Optymalne z chłodzeniem emulsją
 Możliwe z chłodzeniem emulsją

ОБРАЗОВАНИЕ РЕЗЬБЫ РАСКАТНИКАМИ – WYGIATANIE GWINTÓW

FS Standard < Ø 3 mm		FPS Форма пассивного полигона Geometria pasywna					FAS Форма активного полигона Geometria aktywna		
68	69	70	70	70	70	72	73	73	74
			104			104		105	
127						127		127	
147						147		147	
						162		162	



Vc (m/min)
< Ø 20 mm
(Guide line)
Спокрываем VS + CN
Powlekania VS + CN

	FS - 80VS	FS - 80DL	FPS - 80CN	FPS - 81CN	FPS - 80VS	FPS - 81VS	FPS - 84VS	FAS - 80VS	FAS - 81VS	FAS - 84VS	
20 – 40	S	S			SE	SE	SE				11
20 – 40	SE	S			SE	SE	SE	SE	SE	SE	12
20 – 30	SE	S			SE	SE	SE	SE	SE	SE	13
20 – 30	S	S			SE	SE	SE	SE	SE	SE	14
10 – 15	S				S	S	SE	S	S	SE	15
											16
10 – 20	S	SE			S	S	SE	S	S	SE	21
10 – 15		SE						SE	SE	SE	22
6 – 12		SE						S	S	SE	23
6 – 12		S			S	S	S	SE	SE	SE	24
											31
											32
10 – 20		S						S	S	S	41
											42
10 – 15		S						SE	SE	SE	51
											52
											53
10 – 20	S	S						SE	SE	SE	61
											62
20 – 30	SE	SE	SE	SE	S	S	S	S	S	S	63
20 – 40		SE	SE	SE							71
20 – 40		SE	SE	SE							72
20 – 40		SE	SE	SE							73
											74
											81
											82
											83













S Оптимально с маслом
S Допустимо с маслом

S Optymalne z chłodzeniem olejowym
S Możliwe z chłodzeniem olejowym

E Оптимально с эмульсией
E Допустимо с эмульсией

E Optymalne z chłodzeniem emulsją
E Możliwe z chłodzeniem emulsją

	<p>Нарезание резьбы Gwintowanie</p> 		<p>Скоростное нарезание резьбы Gwintowanie na sztywno</p> 
<p>M</p> <p>N 22-45/76-78/285 W 46-47 Z 48-51 H 52-55</p> <p>S 56-57 SA 57-59 TL 58-59 GG 60-61</p> <p>K 66-67</p> <p>MF</p> <p>N 84-93/106-108 Z 94-95 H 96-97 S 98</p> <p>SA 99-101 TL 100-101 K 103</p> <p>UNC, UNC(J)</p> <p>N 114-117/128-129 Z 118-120 H 121 S 122-123</p> <p>SA 124-125 TL 124</p> <p>UNF, UNF(J), UNJF, UNEF, UN, UNS</p> <p>N 134-137/148-151 Z 138-139 H 140-141 S 142</p> <p>SA 143-145 TL 143-144</p> <p>G (BSP), Rp, Rc, W, SV Schaublin</p> <p>N 156-158/163-167 W 159 Z 160-161 H 159</p> <p>GG 159</p> <p>NPT, NPTF, PG, TR</p> <p>N 170-173</p> <p>EG M, EG UNC, EG UNF</p> <p>N 176-177/180/183 Z 181/184 S 184 SA 178-179/182/184-185</p> <p>TL 178/182/185</p>		<p>M</p> <p>RTS 62-65 Z.70/Z.73 50-51 K 66-67</p> <p>MF</p> <p>RTS 102 Z.70 94-95 K 103</p> <p>UNC</p> <p>RTS 126 Z.70 120</p> <p>UNF</p> <p>RTS 146 Z.70 139</p> <p>G (BSP)</p> <p>RTS 161 Z.70 161</p> <p>EG UNC, EG UNF</p> <p>Z.70 181/184</p>	
<p>Корончатые метчики Gwintowniki koronowe</p> 			<p>Образование резьбы раскатниками Wygniatanie gwintów</p> 
<p>M, MF</p> <p>N 187-188</p> <p>UN, G (BSP)</p> <p>N 189</p>		<p>Комбинированные сверла/метчики Wiertło-gwintowniki</p> 	
<p>M, MF</p> <p>N 192</p> <p>UNC, G (BSP), PG</p> <p>N 193</p>			

	<p><i>Фрезерование резьбы микрофрезами</i> Frezowanie gwintów</p> 		<p><i>Резьбовые калибры</i> Sprawdziany do Gwintów</p> 
<p>S, M, MF, UNC, UNF GW 206-213</p>		<p>M D 266-267</p>	
	<p><i>Фрезерование резьбы</i> Frezowanie gwintów</p> 	<p>MF D 268-271</p>	
<p>M GF 214-216 GFH 214 GFS 225-227 GFM 236 BGF 240-242</p> <p>MF GF 217-218 GFS 228-229 GFM 236 BGF 243</p> <p>UNC, UNF, UNEF, UN, UNS GF 219-222 GFS 230-233 GFM 237</p> <p>G (BSP), PG GF 223 GFS 234 GFM 238</p> <p>NPT, NPTF GF 224 GFS 235 GFM 239</p>		<p>UNC, UNF, UNEF D 272-273</p> <p>G (BSP), PG D 274</p> <p>NPT, NPTF D 275</p> <p>EG M, EG UNC, EG UNF D 276</p>	
 <p><i>Плашки</i> Narzynki</p> 			<p><i>Резьбонарезные патроны SRT</i> Oprawki do gwintowania SRT</p> 
<p>M</p>		<p>HSK 278 BT40 278 SK40/SK50 279 DIN1835 B 280-281</p>	
<p>N 246/260/262/263 Z 247/260</p>			
<p>MF</p>		<p>D 282/283 F 284 D 285 D 286-287</p>	
<p>N 248-250/261/262 Z 248-249</p>			
<p>UNC, UNF, UNEF, UN, UNS</p>		<p><i>Скорости резания, таблицы перевода, диаметры под резьбы, диаметры под плашки Технические анкеты Условия поставки и оплаты</i></p>	
<p>N 251-253</p>		<p>Prędkości skrawania, przeliczniki, średnice otworów, tabele średnic wałków Kwestionariusze techniczne Warunki dostawy i płatności</p>	
<p>G (BSP), R</p>			
<p>N 254/256/263 Z 255 MS 255</p>			
<p>NPT, NPTF, PG, TR, W / W Schaublin</p>			
<p>N 257-259/263 N 167</p>			

M

MF

UNC, UNF, UNEF, UN, UNS

UNC, UNF, UNEF, UN, UNS

G, Rp, Rc, W, SV

NPT, NPTF, PG, TR

























EG M, EG UN

























Корончатые метчики
Gwintowniki koronowe























Комбинированные
сверла/метчики
Wiertło-gwintowniki





















		N						
Характеристики Cechy charakterystyczne				 V	 TiN TiCN	 		 V
								
Типы отверстий Typ otworu								
		N310-3	N320-3 N320-4	N320V-3 N320V-4	N320TN-3/4 N320TC-3/4	N321-3 N321-4	N330-3 N330-4	N330V-3 N330V-4
Длинный по DIN DIN długi	DIN 371	22	22/24	24	24	30	30	30
Особо длинный Extra-długi	DC							
Короткий по ISO ISO krótki	ISO 529							
Короткий по DIN DIN krótki	DIN 352							
Длинный по DIN DIN długi	~DIN 2174							
Класс точности Tolerancja	ISO 2 6H	22	22/24	24	24	30	30	30
Класс точности Nadwymiar	ISO 3 6G		28	28				
Класс точности Nadwymiar	7G		28					
Класс точности Nadwymiar	+ 0.10 mm + 0.20 mm		28					
Повышенный класс точности Tolerancja dokładna	ISO 1 4H		26					
Левая резьба LH Gwint lewy	ISO 2 6H	22	26	26				
		N410-3	N420-4	N420V-4	N420TN-4 N420TC-4	N421-4	N430-4	N430V-4
Длинный по DIN DIN długi	DIN 371	23	25	25	25	31	31	31
Особо длинный Extra-długi	DC							
Короткий по ISO ISO krótki	ISO 529							
Короткий по DIN DIN krótki	DIN 352							
Длинный по DIN DIN długi	~DIN 2174							
Класс точности Tolerancja	ISO 2 6H	23	25	25	25	31	31	31
Класс точности Nadwymiar	ISO 3 6G		29	29				
Класс точности Nadwymiar	7G		29					
Класс точности Nadwymiar	+ 0.10 mm + 0.20 mm		29/31					
Повышенный класс точности Tolerancja dokładna	ISO 1 4H		27					
Левая резьба LH Gwint lewy	ISO 2 6H	23	27	27				

N

 R15  V	 R40	 R40  V	 R40 TiN TiCN	 R40 V E 1.5xP	 R40 	 R40  V		 V
								
								
N350-3 N350V-3	N360-3	N360V-3	N360TN-3 N360TC-3	N360-5 N360V-5	N361-3	N362V-3	N520-4	N520V-4
32	34	34	34	40	40	40	42	42
32	34	34	34	40	40	40	42	42
	36	36						
	38	38						
	38							
	36	36						
N450-3 N450V-3	N460-3	N460V-3	N460TN-3 N460TC-3	N460-5 N460V-5	N461-3	N462V-3	N620-4	N620V-4
33	35	35	35	41	41	41	43	43
33	35	35	35	41	41	41	43	43
	37	37						
	39	39						
	39							
	37	37						

		N								
Характеристики Cechy charakterystyczne		 TiN	 R40	 R40	 V	 R40	 TiN		 R40	
										
Типы отверстий Typ otworu										
		N520TN-4	N560-3	N560V-3	N560TN-3	N1120-4	N1160-3	N1110-1-2-3-S		
Длинный по DIN DIN długi	DIN 371									
Особо длинный Extra-długi	DC	42	44	44	44					
Короткий по ISO ISO krótki	ISO 529					78	78	76		
Короткий по DIN DIN krótki	DIN 352									
Длинный по DIN DIN długi	~DIN 2174									
Класс точности Tolerancja	ISO 2 6H	42	44	44	44	78	78	76		
Класс точности Nadwymiar	ISO 3 6G									
Класс точности Nadwymiar	7G									
Класс точности Nadwymiar	+ 0.10 mm + 0.20 mm									
Повышенный класс точности Tolerancja dokładna	ISO 1 4H									
Левая резьба LH Gwint lewy	ISO 2 6H									
		N620TN-4	N660-3	N660V-3	N660TN-3	N1220-4	N1260-3	N1210-1-2-3-S		
Длинный по DIN DIN długi	DIN 371									
Особо длинный Extra-długi	DC	43	45	45	45					
Короткий по ISO ISO krótki	ISO 529					78	78	77		
Короткий по DIN DIN krótki	DIN 352									
Длинный по DIN DIN długi	~DIN 2174									
Класс точности Tolerancja	ISO 2 6H	43	45	45	45	78	78	77		
Класс точности Nadwymiar	ISO 3 6G									
Класс точности Nadwymiar	7G									
Класс точности Nadwymiar	+ 0.10 mm + 0.20 mm									
Повышенный класс точности Tolerancja dokładna	ISO 1 4H									
Левая резьба LH Gwint lewy	ISO 2 6H									

	W				Z			
		 DL		 DL		 VS		 VS
		 NEW		 NEW				
								
	W320-3 W320-4	W320DL-3 W320DL-4	W360-3	W360DL-3	Z320V-3 Z320V-4	Z320VS-4	Z360V-3 Z362V-3	Z360VS-3 Z362VS-3
	46	46	47	47	48	48	49	50
	46	46	47	47	48	48	49	50
	W420-4	W420DL-4	W460-3	W460DL-3	Z420V-4	Z420VS-4	Z462V-3	Z462VS-3
	46	46	47	47	48	48	49	51
	46	46	47	47	48	48	49	51











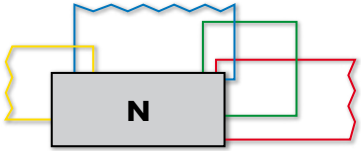





		Z	H	S	SA			
Характеристики Cechy charakterystyczne								
		VS	VS	TiCN	VS			
								
Типы отверстий Typ otworu								
		Z370VS-3	Z373VS-3	H320-4 H320TC-4	H350-3 H350TC-3	S320VS-4	S360VS-3	SA320-4
Длинный по DIN DIN długi	DIN 371	50	50	52	54	56	57	58
Особо длинный Extra-długi	DC							
Короткий по ISO ISO krótki	ISO 529							
Короткий по DIN DIN krótki	DIN 352							
Длинный по DIN DIN długi	~DIN 2174							
Класс точности Tolerancja	ISO 2 6H	50	50	52	54	56	57	58
Класс точности Nadwymiar	ISO 3 6G				54			
Класс точности Nadwymiar	7G							
Класс точности Nadwymiar	+ 0.10 mm + 0.20 mm							
Повышенный класс точности Tolerancja dokładna	ISO 1 4H	50				56		58
Левая резьба LH Gwint lewy	ISO 2 6H							
		Z470VS-3	Z473VS-3	H420-4 H420TC-4	H450-3 H450TC-3	S420VS-4	S460VS-3	SA420-4
Длинный по DIN DIN długi	DIN 371	51	51	53	55	56	57	59
Особо длинный Extra-długi	DC							
Короткий по ISO ISO krótki	ISO 529							
Короткий по DIN DIN krótki	DIN 352							
Длинный по DIN DIN długi	~DIN 2174							
Класс точности Tolerancja	ISO 2 6H	51	51	53	55	56	57	59
Класс точности Nadwymiar	ISO 3 6G				55			
Класс точности Nadwymiar	7G							
Класс точности Nadwymiar	+ 0.10 mm + 0.20 mm							
Повышенный класс точности Tolerancja dokładna	ISO 1 4H							59
Левая резьба LH Gwint lewy	ISO 2 6H							



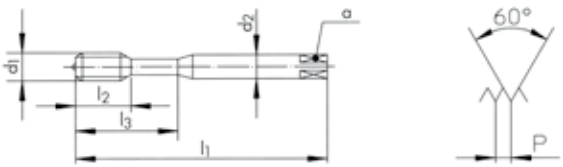







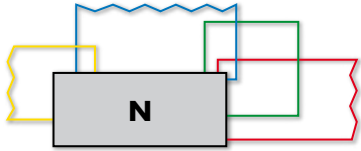

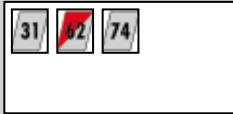

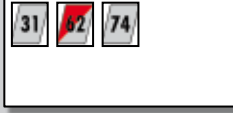
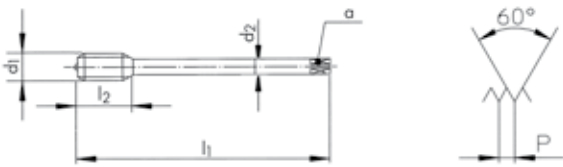





Указатель – Машинные метчики, DIN 13
 Skorowidz - Gwintowniki maszynowe, DIN 13

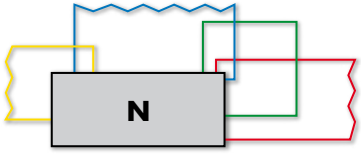





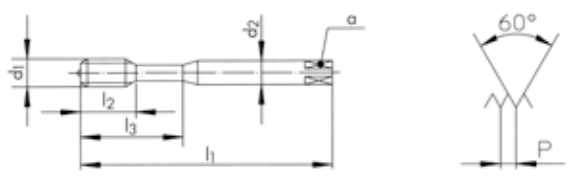
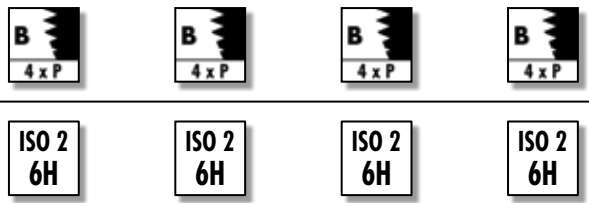

SA		TL		GG			K		
SA350-3	SA390-3	TL320VS-4	TL351VS-3	GG350NV-3 GG550NV-3	GG350TC-3	GG353TC-3	K313TC-3		
58	57	58	58	60 60	60	60	66		
58	57	58	58	60	60	60	66		
58	57	58	58						
SA450-3		TL420VS-4	TL451VS-3	GG450NV-3 GG650NV-3	GG450TC-3	GG453TC-3	K413TC-3 K613TC-3	K613VS-3	
59		59	59	61 61	61	61	66 67	67	
59		59	59	61	61	61	66/67	67	
59		59	59						

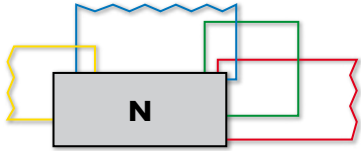

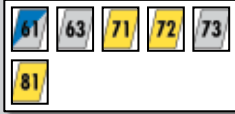

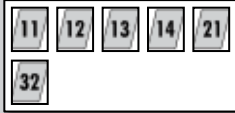



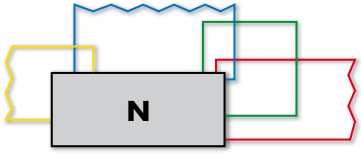

		RTS						
Характеристики Cechy charakterystyczne								
		VS	VS	VS	VS	E 1.5 x P VS		
Типы отверстий Typ otworu								
		RTS320VS-4	RTS323VS-4	RTS360VS-3 RTS362VS-3	RTS365VS-3	RTS362VS-5 RTS365VS-5	RTS523VS-4	RTS565VS-3
Длинный по DIN DIN długi	DIN 371	62	62	63	63	64		
Особо длинный Extra-długi	DC						65	65
Короткий по ISO ISO krótki	ISO 529							
Короткий по DIN DIN krótki	DIN 352							
Длинный по DIN DIN długi	~DIN 2174							
Класс точности Tolerancja	ISO 2 6H	62	62	63	63	64	65	65
Класс точности Nadwymiar	ISO 3 6G			64				
Класс точности Nadwymiar	7G							
Класс точности Nadwymiar	+ 0.10 mm + 0.20 mm							
Повышенный класс точности Tolerancja dokładna	ISO 1 4H							
Левая резьба LH Gwint lewy	ISO 2 6H							
		RTS420VS-4	RTS423VS-4	RTS462VS-3	RTS465VS-3		RTS623VS-4	RTS665VS-3
Длинный по DIN DIN długi	DIN 371	62	62	63	63			
Особо длинный Extra-długi	DC						65	65
Короткий по ISO ISO krótki	ISO 529							
Короткий по DIN DIN krótki	DIN 352							
Длинный по DIN DIN długi	~DIN 2174							
Класс точности Tolerancja	ISO 2 6H	62	62	63	63		65	65
Класс точности Nadwymiar	ISO 3 6G							
Класс точности Nadwymiar	7G							
Класс точности Nadwymiar	+ 0.10 mm + 0.20 mm							
Повышенный класс точности Tolerancja dokładna	ISO 1 4H							
Левая резьба LH Gwint lewy	ISO 2 6H							

									N310-3	N310-3 LH	N320-3	
												
N310-3												
N310-3 LH	 LH											
N320-3												
												
Ø d ₁ M	P mm	l₁ mm	l₂ mm	l₃ mm	d₂ mm	a mm			ID	ID	ID	
1	0.25	40	5.5		2.5	2.1	3	0.75	150167			
1.1	0.25	40	5.5		2.5	2.1	3	0.85	174745			
1.2	0.25	40	5.5		2.5	2.1	3	0.95	150168			
1.4	0.30	40	7.0		2.5	2.1	3	1.10	150169			
1.5	0.30	40	7.0		2.5	2.1	3	1.20	174752			
1.6	0.35	40	8.0		2.5	2.1	3	1.25	174753			
1.7	0.35	40	8.0		2.5	2.1	3	1.35	174754			
1.8	0.35	40	8.0		2.5	2.1	3	1.45	174755			
2	0.40	45	8.0		2.8	2.1	3	1.60	101439	111460		
2.2	0.45	45	9.0		2.8	2.1	3	1.75	174756			
2.3	0.40	45	9.0		2.8	2.1	3	1.90	174757			
2.5	0.45	50	10.0		2.8	2.1	*3	2.05	101440	111461	* 101461	
2.6	0.45	50	10.0		2.8	2.1	3	2.15	101441			
3	0.50	56	12.0	18	3.5	2.7	*3	2.50	101442	111462	* 101462	
3.5	0.60	56	13.0	20	4.0	3.0	*3	2.90	101443		* 101463	
4	0.70	63	14.0	21	4.5	3.4	*3	3.30	101444	111464	* 101464	
5	0.80	70	15.0	25	6.0	4.9	*3	4.20	101445	111465	* 101465	
6	1.00	80	17.0	30	6.0	4.9	*3	5.00	101446	111466	* 101466	
8	1.25	90	20.0	35	8.0	6.2	3	6.80	101447			
10	1.50	100	22.0	39	10.0	8.0	3	8.50	101438			
<p>* N320-3 =  2</p>									<p>≤ M1.5 </p>			

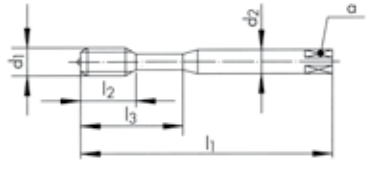
								N410-3	N410-3 LH			
												
N410-3												
N410-3 LH		LH										
												
												
$\varnothing d_1$	P	l_1	l_2	d_2	α			ID	ID			
M	mm	mm	mm	mm	mm							
3	0.50	56	12.0	2.2	1.8	3	2.50	101897				
4	0.70	63	14.0	2.8	2.1	3	3.30	101924				
5	0.80	70	15.0	3.5	2.7	3	4.20	101942				
6	1.00	80	17.0	4.5	3.4	3	5.00	101953				
7	1.00	80	17.0	5.5	4.3	3	6.00	142645	111491			
8	1.25	90	20.0	6.0	4.9	3	6.80	101958	111492			
10	1.50	100	22.0	7.0	5.5	3	8.50	101866	111478			
12	1.75	110	24.0	9.0	7.0	3	10.20	101870	111479			
14	2.00	110	28.0	11.0	9.0	3	12.00	101874	111480			
16	2.00	110	30.0	12.0	9.0	3	14.00	101880	111481			
18	2.50	125	33.0	14.0	11.0	3	15.50	101883	111482			
20	2.50	140	36.0	16.0	12.0	3	17.50	101885	125530			
22	2.50	140	36.0	18.0	14.5	3	19.50	101888				
24	3.00	160	39.0	18.0	14.5	4	21.00	101891	111485			
27	3.00	160	42.0	20.0	16.0	4	24.00	101895	111486			
30	3.50	180	45.0	22.0	18.0	4	26.50	101901	111487			
33	3.50	180	48.0	25.0	20.0	4	29.50	101907				
36	4.00	200	51.0	28.0	22.0	4	32.00	101915	111488			
39	4.00	200	55.0	32.0	24.0	4	35.00	101922				
42	4.50	200	55.0	32.0	24.0	4	37.50	101932				
48	5.00	250	63.0	36.0	29.0	4	43.00	111489				
56	5.50	280	71.0	45.0	35.0	5	50.50	111447				

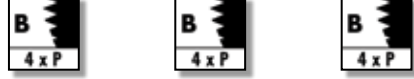
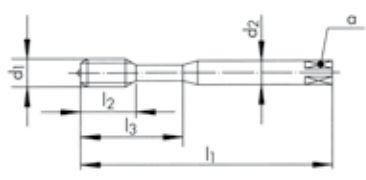









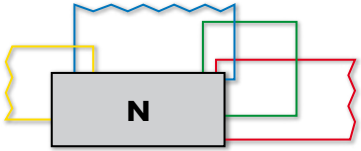

									N320-4	N320V-4	N320TN-4	N320TC-4	
													
N320-4													
N320V-4		V											
N320TN-4		TiN											
N320TC-4		TiCN											
													
Ø d ₁	P	l ₁	l ₂	l ₃	d ₂	a			ID	ID	ID	ID	
M	mm	mm	mm	mm	mm	mm							
*1	0.25	40	5.5		2.5	2.1	2	0.75	111467				
*1.1	0.25	40	5.5		2.5	2.1	2	0.85	111468				
*1.2	0.25	40	5.5		2.5	2.1	2	0.95	111469				
*1.4	0.30	40	7.0		2.5	2.1	2	1.10	111470				
*1.5	0.30	40	7.0		2.5	2.1	2	1.20	111471				
*1.6	0.35	40	8.0		2.5	2.1	2	1.25	101454				
*1.7	0.35	40	8.0		2.5	2.1	2	1.35	101455				
*1.8	0.35	40	8.0		2.5	2.1	2	1.45	101456				
*2	0.40	45	8.0		2.8	2.1	2	1.60	101458	101536	101528	152900	
*2.2	0.45	45	9.0		2.8	2.1	2	1.75	101459				
*2.3	0.40	45	9.0		2.8	2.1	2	1.90	101460				
2.5	0.45	50	10.0		2.8	2.1	3	2.05	101483	101545	101530	101522	
2.6	0.45	50	10.0		2.8	2.1	3	2.15	101484				
3	0.50	56	12.0	18	3.5	2.7	3	2.50	101485	101546	101531	101523	
3.5	0.60	56	13.0	20	4.0	3.0	3	2.90	101491	101547			
4	0.70	63	14.0	21	4.5	3.4	3	3.30	101495	101548	101532	101524	
5	0.80	70	15.0	25	6.0	4.9	3	4.20	101499	101549	101533	101525	
6	1.00	80	17.0	30	6.0	4.9	3	5.00	101503	101550	101534	101526	
8	1.25	90	20.0	35	8.0	6.2	3	6.80	101506	101551	101535	101527	
10	1.50	100	22.0	39	10.0	8.0	3	8.50	101481	101544	101529	101521	
<p>* N320-3 / N320V-3 N320TN-3 / N320TC-3</p> 									<p>≤ M1.5</p> 				

								N420-4	N420V-4	N420TN-4	N420TC-4
											
N420-4											
N420V-4		V									
N420TN-4		TiN									
N420TC-4		TiCN									
											
$\varnothing d_1$	P	l_1	l_2	d_2	α			ID	ID	ID	ID
M	mm	mm	mm	mm	mm						
3	0.50	56	12.0	2.2	1.8	3	2.50	102119	143418		
4	0.70	63	14.0	2.8	2.1	3	3.30	102146	102279		
5	0.80	70	15.0	3.5	2.7	3	4.20	102171	102280	146297	
6	1.00	80	17.0	4.5	3.4	3	5.00	102182	102282	147439	
7	1.00	80	17.0	5.5	4.3	3	6.00	102189	144713		
8	1.25	90	20.0	6.0	4.9	3	6.80	102195	102285	102251	102233
9	1.25	90	20.0	7.0	5.5	3	7.80	102202			
10	1.50	100	22.0	7.0	5.5	3	8.50	102061	102263	102240	102228
11	1.50	100	19.0	8.0	6.2	3	9.50	162770			
12	1.75	110	24.0	9.0	7.0	3	10.20	102072	102265	102243	102229
14	2.00	110	28.0	11.0	9.0	3	12.00	102081	102267	102245	
16	2.00	110	30.0	12.0	9.0	3	14.00	102090	102269	102247	102231
18	2.50	125	33.0	14.0	11.0	3	15.50	102097	102271		
20	2.50	140	36.0	16.0	12.0	3	17.50	102101	102273	102248	102232
22	2.50	140	36.0	18.0	14.5	3	19.50	102106	102275		
24	3.00	160	39.0	18.0	14.5	4	21.00	102110	102278	144220	163736
27	3.00	160	42.0	20.0	16.0	4	24.00	102117	143856		
30	3.50	180	45.0	22.0	18.0	4	26.50	102124	105124		
33	3.50	180	48.0	25.0	20.0	4	29.50	102130	146968		
36	4.00	200	51.0	28.0	22.0	4	32.00	102137	143430		
39	4.00	200	55.0	32.0	24.0	4	35.00	102144	158724		
42	4.50	200	55.0	32.0	24.0	4	37.50	102158	143107		
45	4.50	220	59.0	36.0	29.0	4	40.50	* 110225			
48	5.00	250	63.0	36.0	29.0	4	43.00	110226	157517		
56	5.50	280	71.0	45.0	35.0	5	50.50	110229	158178		

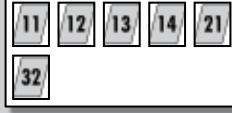
										N320-4	N320-4 LH	N320V-4 LH	
													
N320-4													
N320-4 LH		LH											
N320V-4 LH		V	LH										
 													
										ISO 1 4H	ISO 2 6H	ISO 2 6H	
Ø d ₁ M	P mm	l ₁ mm	l ₂ mm	l ₃ mm	d ₂ mm	a mm				ID	ID	ID	
*2	0.40	45	8.0		2.8	2.1	2	1.60		162503	111472	162771	
2.5	0.45	50	10.0		2.8	2.1	3	2.05		159345			
3	0.50	56	12.0	18	3.5	2.7	3	2.50		101487	111473	162772	
4	0.70	63	14.0	21	4.5	3.4	3	3.30		101493	111474	162773	
5	0.80	70	15.0	25	6.0	4.9	3	4.20		101497	111475	162774	
6	1.00	80	17.0	30	6.0	4.9	3	5.00		101501	111476	162775	
8	1.25	90	20.0	35	8.0	6.2	3	6.80	Δ	* 146482			
10	1.50	100	22.0	39	10.0	8.0	3	8.50		* 146484			
<p>* N320-3 </p> <p>Δ ISO 1 4H =  6.70</p>													

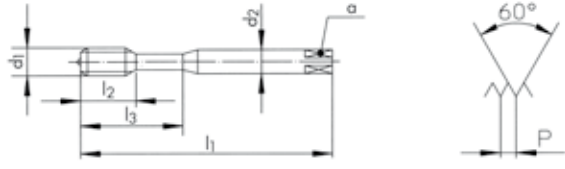
									N420-4	N420-4 LH	N420V-4 LH	
N420-4												
N420-4 LH	LH											
N420V-4 LH	V LH											
$\varnothing d_1$	P	l_1	l_2	d_2	α				ISO 1 4H	ISO 2 6H	ISO 2 6H	
M	mm	mm	mm	mm	mm				ID	ID	ID	
8	1.25	90	20.0	6.0	4.9	3	Δ 6.80		102193	102198	142621	
10	1.50	100	22.0	7.0	5.5	3	8.50		102059	102064	143287	
12	1.75	110	24.0	9.0	7.0	3	10.20		102070	102040	146583	
14	2.00	110	28.0	11.0	9.0	3	12.00			102084	146563	
16	2.00	110	30.0	12.0	9.0	3	14.00			102093	143108	
20	2.50	140	36.0	16.0	12.0	3	17.50			102103	145579	
24	3.00	160	39.0	18.0	14.5	4	21.00			111493	145578	
30	3.50	180	45.0	22.0	18.0	4	26.50			* 111494		











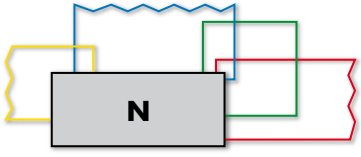

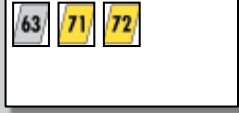

Δ ISO 1 4H = 6.70

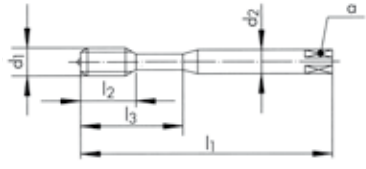
									N320-4	N320V-4	N320-4	N320-4			
															
N320-4															
N320V-4	 V														
															
Ø d ₁ M	P mm	l ₁ mm	l ₂ mm	l ₃ mm	d ₂ mm	a mm			ID	6H + mm	ID	6H + mm	ID	6H + mm	ID
*2	0.40	45	8.0		2.8	2.1	2	1.60	101457	0.019	143584	0.019			
2.5	0.45	50	10.0		2.8	2.1	3	2.05	101482	0.020	150522	0.020			
3	0.50	56	12.0	18	3.5	2.7	3	2.50	101486	0.020	143116	0.020	101489	0.036	101488
3.5	0.60	56	13.0	20	4.0	3.0	3	2.95	101490	0.021					
4	0.70	63	14.0	21	4.5	3.4	3	3.35	101494	0.022	143087	0.022	101496	0.041	111522
5	0.80	70	15.0	25	6.0	4.9	3	4.25	101498	0.024	143088	0.024	101500	0.044	111523
6	1.00	80	17.0	30	6.0	4.9	3	5.00	101502	0.026	143089	0.026	101504	0.050	111524
8	1.25	90	20.0	35	8.0	6.2	3	6.80	101505	0.028	143604	0.028			

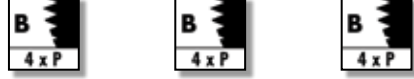









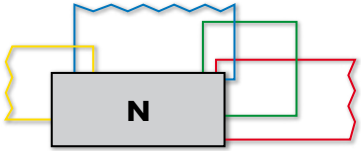





* N320-3 / N320V-3



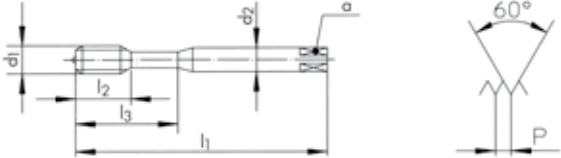







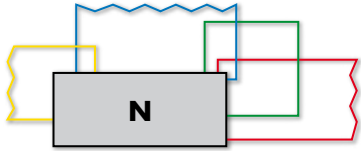







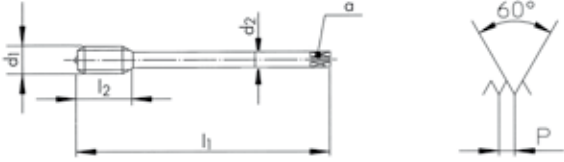







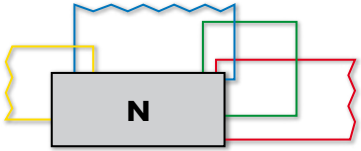



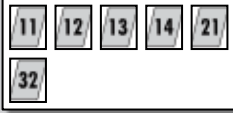

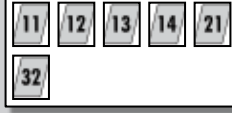

									N420-4	N420V-4	N420-4	N420-4										
N420-4		<table border="1"> <tr> <td>61</td> <td>63</td> <td>71</td> <td>72</td> <td>73</td> </tr> <tr> <td>81</td> <td colspan="4"></td> </tr> </table>							61	63	71	72	73	81								
61	63	71	72	73																		
81																						
N420V-4	V	<table border="1"> <tr> <td>11</td> <td>12</td> <td>13</td> <td>14</td> <td>21</td> </tr> <tr> <td>32</td> <td colspan="4"></td> </tr> </table>							11	12	13	14	21	32								
11	12	13	14	21																		
32																						
									<table border="1"> <tr> <td></td> <td></td> <td></td> <td></td> </tr> <tr> <td>ISO 3 6G</td> <td>ISO 3 6G</td> <td>7G</td> <td>6H +0.1mm</td> </tr> </table>								ISO 3 6G	ISO 3 6G	7G	6H +0.1mm		
ISO 3 6G	ISO 3 6G	7G	6H +0.1mm																			
$\varnothing d_1$	P	l_1	l_2	d_2	α				ID	6H	ID	6H	ID	6H	ID							
M	mm	mm	mm	mm	mm		$\rightarrow \leftarrow$		+ mm	+ mm	+ mm											
8	1.25	90	20.0	6.0	4.9	3	6.80		102194	0.028	145246	0.028	102199	0.052	102196							
10	1.50	100	22.0	7.0	5.5	3	8.50		102060	0.032	143726	0.032	102065	0.060	102062							
12	1.75	110	24.0	9.0	7.0	3	10.30		102071	0.034	145655	0.034	102076	0.066	102073							
16	2.00	110	30.0	12.0	9.0	3	14.00		135531	0.038	162795	0.038	102094	0.072	102091							

									N321-4	N330-4	N330V-4	
												
N321-4												
N330-4												
N330V-4												
												
												
Ø d ₁ M	P mm	l ₁ mm	l ₂ mm	l ₃ mm	d ₂ mm	a mm		6H 	ID	ID	ID	
*1	0.25	40	5.5		2.5	2.1	2	0.75		101558		
*1.1	0.25	40	5.5		2.5	2.1	2	0.85		* 101559		
*1.2	0.25	40	5.5		2.5	2.1	2	0.95		101560		
*1.4	0.30	40	7.0		2.5	2.1	2	1.10		101561		
*1.6	0.35	40	8.0		2.5	2.1	2	1.25		101562	151246	
*1.7	0.35	40	8.0		2.5	2.1	2	1.35		* 101563		
*2	0.40	45	8.0		2.8	2.1	2	1.60	101552	105125	101572	
*2.2	0.45	45	9.0		2.8	2.1	2	1.75		* 105126		
*2.3	0.40	45	9.0		2.8	2.1	2	1.90		* 105127		
2.5	0.45	50	10.0		2.8	2.1	*3	2.05	101553	101565	101573	
2.6	0.45	50	10.0		2.8	2.1	2	2.15		* 101566		
3	0.50	56	12.0	18	3.5	2.7	*3	2.50	101555	101567	101574	
3.5	0.60	56	13.0	20	4.0	3.0	2	2.90		101568		
4	0.70	63	14.0	21	4.5	3.4	3	3.30	101557	101569	101576	
5	0.80	70	15.0	25	6.0	4.9	3	4.20		101570	101577	
6	1.00	80	17.0	30	6.0	4.9	3	5.00		101571	101578	
<p>* N321-3 / N330-3 / N330V-3  * N330-4 =  2</p> <p>* N330V-4 =  2</p>									<p>≤ M1.5 </p>			



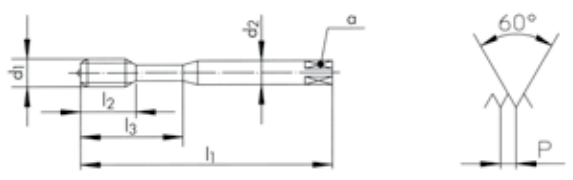





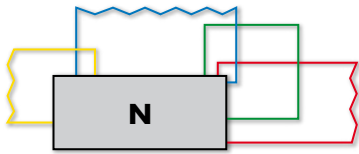





























								N420-4	N421-4	N430-4	N430V-4
N420-4											
N421-4											
N430-4											
N430V-4											
$\varnothing d_1$ M	P mm	l_1 mm	l_2 mm	d_2 mm	α mm		$\pm 6H$ mm	ID	ID	ID	ID
4	0.70	63	14.0	2.8	2.1	3	3.30		102293		
5	0.80	70	15.0	3.5	2.7	3	4.20		102294		
6	1.00	80	17.0	4.5	3.4	3	5.00		102295		
8	1.25	90	20.0	6.0	4.9	3	6.80	102197	102296	102301	102306
10	1.50	100	22.0	7.0	5.5	3	8.50	102063	102286	102297	102302
12	1.75	110	24.0	9.0	7.0	3	10.20	102074	102287	102298	102303
14	2.00	110	28.0	11.0	9.0	3	12.00		* 102288		
16	2.00	110	30.0	12.0	9.0	3	14.00	102092	102289		

									N350-3	N350V-3		
												
N350-3												
N350V-3	 											
									 			
												
									 			
												
Ø d ₁ M	P mm	l ₁ mm	l ₂ mm	l ₃ mm	d ₂ mm	a mm			ID	ID		
2	0.40	45	8.0		2.8	2.1	2	1.60	101580	101593		
2.3	0.40	45	9.0		2.8	2.1	2	1.90	101581			
2.5	0.45	50	10.0		2.8	2.1	2	2.05	101582	101594		
2.6	0.45	50	10.0		2.8	2.1	2	2.15	101583			
3	0.50	56	12.0	18	3.5	2.7	2	2.50	101584	101595		
3.5	0.60	56	13.0	20	4.0	3.0	2	2.90	101585			
4	0.70	63	14.0	21	4.5	3.4	2	3.30	101587	101596		
5	0.80	70	15.0	25	6.0	4.9	3	4.20	101589	101597		
6	1.00	80	17.0	30	6.0	4.9	3	5.00	101591	101598		
8	1.25	90	20.0	35	8.0	6.2	3	6.80	101592	146810		
10	1.50	100	22.0	39	10.0	8.0	3	8.50	101579	147217		

									N450-3	N450V-3			
									N450-3  	 	N450V-3   		
													
													
													
$\varnothing d_1$ M	P mm	l_1 mm	l_2 mm	d_2 mm	α mm			ID	ID				
8	1.25	90	20.0	6.0	4.9	3	6.80	102327	102334				
10	1.50	100	22.0	7.0	5.5	3	8.50	102314	102329				
12	1.75	110	24.0	9.0	7.0	3	10.20	102317	102330				
14	2.00	110	28.0	11.0	9.0	3	12.00	102319	145487				
16	2.00	110	30.0	12.0	9.0	3	14.00	102321	102331				
20	2.50	140	36.0	16.0	12.0	4	17.50	102324	102332				
24	3.00	160	39.0	18.0	14.5	4	21.00	102325	102333				



									N360-3	N360V-3	N360TN-3	N360TC-3
												
N360-3												
N360V-3	 V											
N360TN-3	 TiN											
N360TC-3	 TiCN											
												
												
Ø d ₁ M	P mm	l ₁ mm	l ₂ mm	l ₃ mm	d ₂ mm	a mm			ID	ID	ID	ID
2	0.40	45	7.0		2.8	2.1	2	1.60	101618	101708	101697	146842
2.2	0.45	45	8.0		2.8	2.1	2	1.75	101619			
2.3	0.40	45	8.0		2.8	2.1	2	1.90	101620			
2.5	0.45	50	9.0		2.8	2.1	2	2.05	101622	101709	101698	101689
2.6	0.45	50	9.0		2.8	2.1	2	2.15	101623	101710		
3	0.50	56	5.5	18	3.5	2.7	3	2.50	101626	101711	101699	101690
3.5	0.60	56	6.5	20	4.0	3.0	3	2.90	101630	142625		
4	0.70	63	7.5	21	4.5	3.4	3	3.30	101635	101713	101700	101691
4.5	0.75	70	9.0	25	6.0	4.9	3	3.75	101639			
5	0.80	70	9.0	25	6.0	4.9	3	4.20	101644	101715	101701	101692
6	1.00	80	11.0	30	6.0	4.9	3	5.00	101652	101717	101703	101693
7	1.00	80	11.0	30	7.0	5.5	3	6.00	101656	101718		
8	1.25	90	12.5	35	8.0	6.2	3	6.80	101663	101721	101705	101694
9	1.25	90	12.5	35	9.0	7.0	3	7.80	101668			
10	1.50	100	14.0	39	10.0	8.0	3	8.50	101612	101707	101696	101688





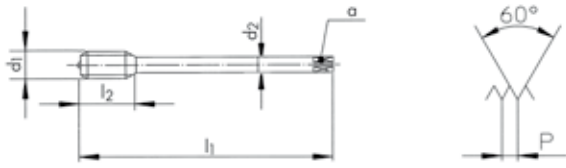





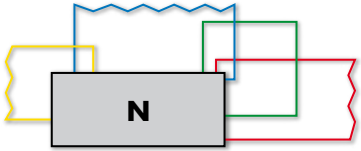

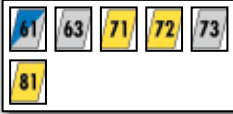

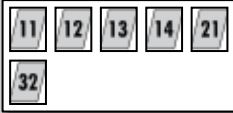



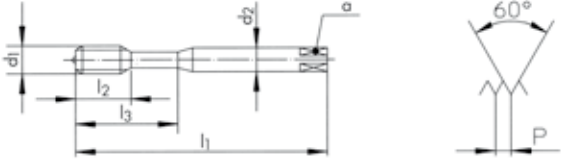



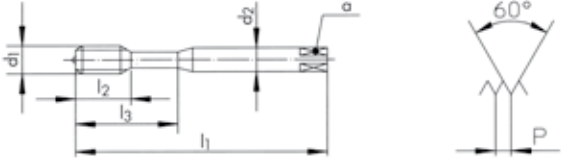





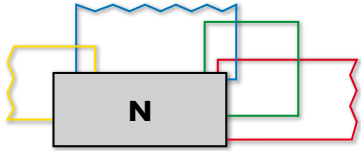



















N460-3		     
N460V-3	 	     
N460TN-3	 	        
N460TC-3	 	          







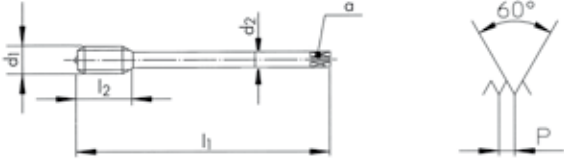



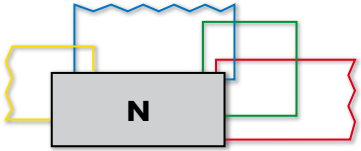

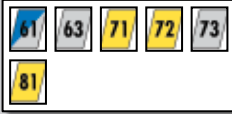



















N460-3	N460V-3	N460TN-3	N460TC-3
--------	---------	----------	----------

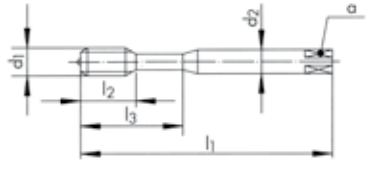



Ø d ₁ M	P mm	l ₁ mm	l ₂ mm	d ₂ mm	α mm			ID	ID	ID	ID
5	0.80	70	9.0	3.5	2.7	3	4.20	102410	102489	160682	
6	1.00	80	11.0	4.5	3.4	3	5.00	102411	102491	152850	
8	1.25	90	12.5	6.0	4.9	3	6.80	102412	102492	152849	
10	1.50	100	14.0	7.0	5.5	3	8.50	102351	102461	150242	158687
12	1.75	110	14.0	9.0	7.0	3	10.20	102359	102465	102449	102438
14	2.00	110	14.0	11.0	9.0	3	12.00	102369	102468	102451	111615
16	2.00	110	18.0	12.0	9.0	3	14.00	102376	102471	102453	102440
18	2.50	125	21.0	14.0	11.0	3	15.50	102383	102473		
20	2.50	140	24.0	16.0	12.0	4	17.50	102389	102475	102454	143280
22	2.50	140	24.0	18.0	14.5	4	19.50	102394	102477		
24	3.00	160	27.0	18.0	14.5	4	21.00	102398	102480	143119	150018
27	3.00	160	27.0	20.0	16.0	4	24.00	175423	102481		
30	3.50	180	30.0	22.0	18.0	4	26.50	150246	102482		
33	3.50	180	33.0	25.0	20.0	4	29.50	167621	102483		
36	4.00	200	36.0	28.0	22.0	5	32.00	143914	102484		
39	4.00	200	40.0	32.0	24.0	5	35.00	175424	102485		
42	4.50	200	40.0	32.0	24.0	5	37.50	169122	102486		
45	4.50	220	44.0	36.0	29.0	5	40.50		102487		
48	5.00	250	48.0	36.0	29.0	5	43.00		102488		
52	5.00	250	52.0	40.0	32.0	5	47.00		110228		
56	5.50	280	56.0	45.0	35.0	6	50.50		102490		
64	6.00	315	64.0	50.0	39.0	6	58.00		143805		

									N360-3 LH	N360V-3 LH	N360-3	N360V-3
												
N360-3 LH		LH										
N360V-3 LH		V LH										
N360-3												
N360V-3		V										
												
												
Ø d ₁ M	P mm	l ₁ mm	l ₂ mm	l ₃ mm	d ₂ mm	a mm		6H → ←	ID	ID	ID 6H + mm	ID 6H + mm
2	0.40	45	7.0		2.8	2.1	2	1.60			101617 0.019	146000 0.019
2.5	0.45	50	9.0		2.8	2.1	2	2.05			101621 0.020	143294 0.020
3	0.50	56	5.5	18	3.5	2.7	3	2.50	101627	146811	101625 0.020	104816 0.020
3.5	0.60	56	6.5	20	4.0	3.0	3	2.95			101629 0.021	125829 0.021
4	0.70	63	7.5	21	4.5	3.4	3	3.30	101637	162540	101634 0.022	104817 0.022
5	0.80	70	9.0	25	6.0	4.9	3	4.20	101646	144003	101643 0.024	104818 0.024
6	1.00	80	11.0	30	6.0	4.9	3	5.00	101654	144004	101669 0.026	104819 0.026
8	1.25	90	12.5	35	8.0	6.2	3	6.80	101666	143925	101662 0.028	104820 0.028
10	1.50	100	14.0	39	10.0	8.0	3	8.50	101615	143587	101611 0.032	104821 0.032

								N460-3 LH	N460V-3 LH	N460-3	N460V-3		
								   					
  								   					
   								   					
 								   					
  													
													
$\varnothing d_1$ M	P mm	l_1 mm	l_2 mm	d_2 mm	α mm		$6H$ $\rightarrow \leftarrow$	ID	ID	ID	$6H$ + mm	ID	$6H$ + mm
12	1.75	110	14.0	9.0	7.0	3	10.20	102362	146354	102358	0.034	143602	0.034
14	2.00	110	14.0	11.0	9.0	3	12.00			102368	0.038	144712	0.038
16	2.00	110	18.0	12.0	9.0	3	14.00	102378	143439	102375	0.038	150197	0.038
20	2.50	140	24.0	16.0	12.0	4	17.50	102390	146564	102388	0.042	145420	0.042

									N360-3	N360-3	N360V-3	N360-3		
														
N360-3														
N360V-3	 													
 														
Ø d ₁ M	P mm	l ₁ mm	l ₂ mm	l ₃ mm	d ₂ mm	a mm			ID	ID	6H + mm	ID	6H + mm	ID
3	0.50	56	5.5	18	3.5	2.7	3	2.50	101624	101628	0.036	144311	0.036	160847
4	0.70	63	7.5	21	4.5	3.4	3	3.30	101633	101638	0.041	144192	0.041	101636
5	0.80	70	9.0	25	6.0	4.9	3	4.20	101642	101647	0.044	143208	0.044	101645
6	1.00	80	11.0	30	6.0	4.9	3	5.00	101651	101655	0.050	146709	0.050	101653
8	1.25	90	12.5	35	8.0	6.2	3	△ 6.80	101661	101667	0.052	146267	0.052	101664
10	1.50	100	14.0	39	10.0	8.0	3	8.50	101610	101616	0.060	142547	0.060	101613

△  =  6.70

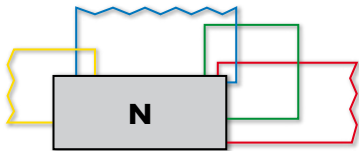

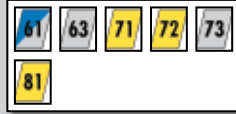

N460-3 N460-3 N460V-3 N460-3

N460-3



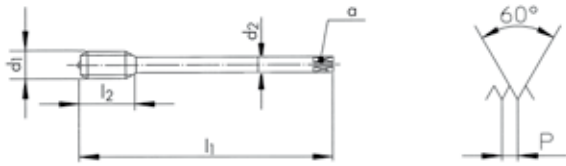
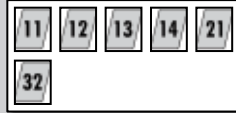







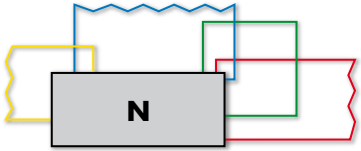

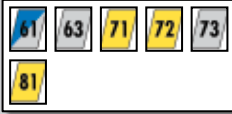

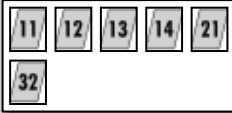







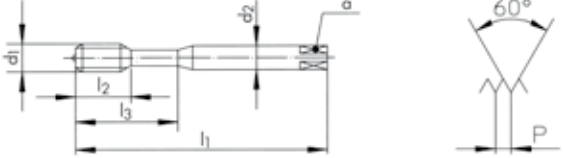





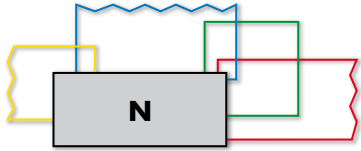







N460V-3

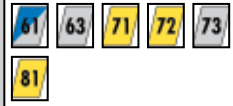

∅ d ₁ M	P mm	l ₁ mm	l ₂ mm	d ₂ mm	a mm		
12	1.75	110	14.0	9.0	7.0	3	10.20
16	2.00	110	18.0	12.0	9.0	3	14.00

ID	ID	6H + mm	ID	6H + mm	ID
* 124987	102363	0.066	142532	0.066	102360
	102379	0.072	144956	0.072	102377

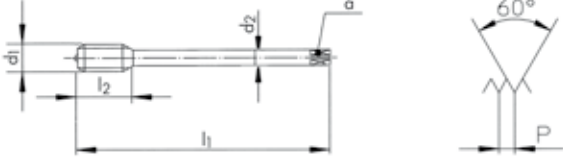
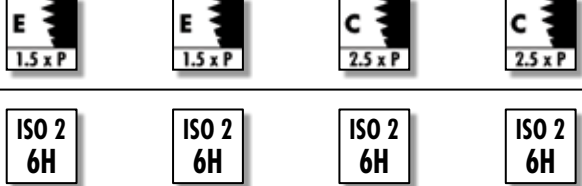
									N360-5	N360V-5	N361-3	N362V-3
												
N360-5												
N360V-5	 											
N361-3	 											
N362V-3	  											
												
												
Ø d ₁ M	P mm	l ₁ mm	l ₂ mm	l ₃ mm	d ₂ mm	a mm			ID	ID	ID	ID
2	0.40	45	7.0		2.8	2.1	2	1.60	158079	150058		
3	0.50	56	5.5	18	3.5	2.7	3	2.50	104809	142646	101735	
4	0.70	63	7.5	21	4.5	3.4	3	3.30	104810	142647	101736	101741
5	0.80	70	9.0	25	6.0	4.9	3	4.20	104811	142648	101737	101742
6	1.00	80	11.0	30	6.0	4.9	3	5.00	104812	142649	101738	101743
8	1.25	90	12.5	35	8.0	6.2	3	6.80	104813	142650	101739	101744
10	1.50	100	14.0	39	10.0	8.0	3	8.50	104814	124899	101734	101740

								N460-5	N460V-5	N461-3	N462V-3
											
N460-5											
N460V-5	 										
N461-3											
N462V-3	  										
											
$\varnothing d_1$	P	l_1	l_2	d_2	α			ID	ID	ID	ID
M	mm	mm	mm	mm	mm						
12	1.75	110	14.0	9.0	7.0	3	10.20	104815	142651	102506	102512
14	2.00	110	14.0	11.0	9.0	3	12.00			* 102507	102513
16	2.00	110	18.0	12.0	9.0	3	14.00			* 102508	102514
18	2.50	125	21.0	14.0	11.0	3	15.50			* 111614	102515
20	2.50	140	24.0	16.0	12.0	4	17.50				102516
24	3.00	160	27.0	18.0	14.5	4	21.00				102517
27	3.00	160	27.0	20.0	16.0	4	24.00				159244
30	3.50	180	30.0	22.0	18.0	4	26.50				143090



										N520-4	N520V-4	N520TN-4		
N520-4														
N520V-4		V												
N520TN-4		TiN												
Ø d ₁ M	P mm	l₁ mm	l₂ mm	l₃ mm	d₂ mm	a mm				ID	ID	ID		
2.5	0.45	100	10.0		2.8	2.1	3			102594	142623			
3	0.50	112	12.0	18	3.5	2.7	3			102595	143399	162790		
4	0.70	112	14.0	21	4.5	3.4	3			102596	143400	146837		
5	0.80	125	15.0	25	6.0	4.9	3			102597	142654	150113		
6	1.00	125	17.0	30	6.0	4.9	3			102598	143137	148821		



									N620-4	N620V-4	N620TN-4											
N620-4		<table border="1"> <tr> <td>61</td> <td>63</td> <td>71</td> <td>72</td> <td>73</td> </tr> <tr> <td>81</td> <td colspan="4"></td> </tr> </table>							61	63	71	72	73	81								
61	63	71	72	73																		
81																						
N620V-4	V	<table border="1"> <tr> <td>11</td> <td>12</td> <td>13</td> <td>14</td> <td>21</td> </tr> <tr> <td>32</td> <td colspan="4"></td> </tr> </table>							11	12	13	14	21	32								
11	12	13	14	21																		
32																						
N620TN-4	TiN	<table border="1"> <tr> <td>11</td> <td>12</td> <td>13</td> <td>14</td> <td>21</td> </tr> <tr> <td>31</td> <td>32</td> <td>73</td> <td>74</td> <td></td> </tr> </table>							11	12	13	14	21	31	32	73	74					
11	12	13	14	21																		
31	32	73	74																			
									<table border="1"> <tr> <td>B 4 x P</td> <td>B 4 x P</td> <td>B 4 x P</td> </tr> </table>			B 4 x P	B 4 x P	B 4 x P								
B 4 x P	B 4 x P	B 4 x P																				
									<table border="1"> <tr> <td>ISO 2 6H</td> <td>ISO 2 6H</td> <td>ISO 2 6H</td> </tr> </table>			ISO 2 6H	ISO 2 6H	ISO 2 6H								
ISO 2 6H	ISO 2 6H	ISO 2 6H																				
$\varnothing d_1$ M	P mm	l₁ mm	l₂ mm	d₂ mm	α mm				ID	ID	ID											
4	0.70	112	14.0	2.8	2.1	3	3.30		102619	142582	146442											
5	0.80	125	15.0	3.5	2.7	3	4.20		102620	142657	146443											
6	1.00	125	17.0	4.5	3.4	3	5.00		102621	142658	144591											
8	1.25	140	20.0	6.0	4.9	3	6.80		102622	143401	146262											
10	1.50	160	22.0	7.0	5.5	3	8.50		102614	142660	146849											
12	1.75	180	24.0	9.0	7.0	3	10.20		102615	143127	146295											
14	2.00	180	28.0	11.0	9.0	3	12.00		102616	151905												
16	2.00	200	30.0	12.0	9.0	3	14.00		102617	143106	143574											
20	2.50	224	36.0	16.0	12.0	3	17.50		102618	143596												



										N560-3	N560V-3	N560TN-3	
N560-3													
N560V-3	V												
N560TN-3	TiN												
Ø d ₁ M	P mm	l₁ mm	l₂ mm	l₃ mm	d₂ mm	a mm				ID	ID	ID	
2.5	0.45	100	9.0		2.8	2.1	2	2.05		102600	102607		
3	0.50	112	5.5	18	3.5	2.7	3	2.50		102601	102608	142663	
4	0.70	112	7.5	21	4.5	3.4	3	3.30		102602	102609	142664	
5	0.80	125	9.0	25	6.0	4.9	3	4.20		102603	102610	142665	
6	1.00	125	11.0	30	6.0	4.9	3	5.00		102604	102611	142666	
8	1.25	140	12.5	35	8.0	6.2	3	6.80		102605	102612	142667	
10	1.50	160	14.0	39	10.0	8.0	3	8.50		102599	102606	142668	

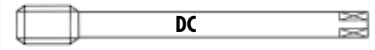









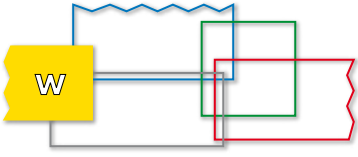

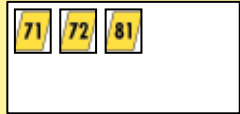











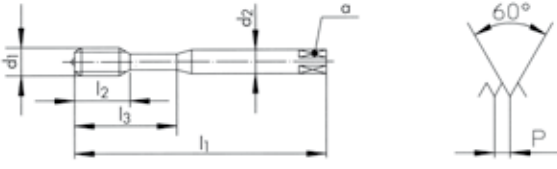



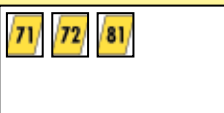



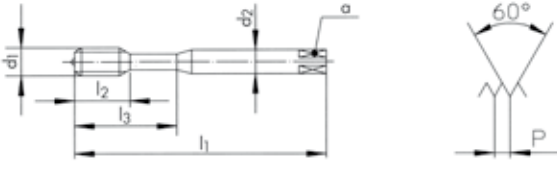







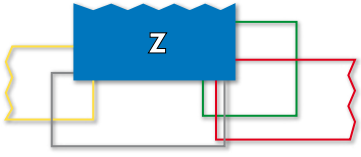















								N660-3	N660V-3	N660TN-3	
N660-3											
N660V-3											
N660TN-3											
$\varnothing d_1$	P	l_1	l_2	d_2	α			ID	ID	ID	
M	mm	mm	mm	mm	mm						
6	1.00	125	11.0	4.5	3.4	3	5.00	162792	115657		
8	1.25	140	12.5	6.0	4.9	3	6.80	162793	115544		
10	1.50	160	14.0	7.0	5.5	3	8.50	162794	135539	173484	
12	1.75	180	14.0	9.0	7.0	3	10.20	102623	102626	142669	
14	2.00	180	14.0	11.0	9.0	3	12.00	162253	147500		
16	2.00	200	18.0	12.0	9.0	3	14.00	102624	102627	142670	
20	2.50	224	24.0	16.0	12.0	4	17.50	102625	102628		

									W320-4	W420-4	W320DL-4	W420DL-4	
W320-4		71 72 81											
W420-4		71 72 81											
W320DL-4		DL	71 72 81							NEW			
W420DL-4		DL	71 72 81							NEW			
$\varnothing d_1$ M	P mm	l_1 mm	l_2 mm	l_3 mm	d_2 mm	a mm			ID	ID	ID	ID	
*2	0.40	45	8.0		2.8	2.1	2	1.60	104612		176688		
2.5	0.45	50	10.0		2.8	2.1	2	2.05	104613		176689		
2.6	0.45	50	10.0		2.8	2.1	2	2.15	* 104614				
3	0.50	56	12.0	18	3.5	2.7	2	2.50	104615		176690		
3.5	0.60	56	13.0	20	4.0	3.0	2	2.90	* 104616				
4	0.70	63	14.0	21	4.5	3.4	2	3.30	104617		176691		
5	0.80	70	15.0	25	6.0	4.9	2	4.20	104618		176354		
6	1.00	80	17.0	30	6.0	4.9	2	5.00	104619		175590		
8	1.25	90	20.0		6.0	4.9	2	6.80		104636		176692	
10	1.50	100	22.0		7.0	5.5	2	8.50		104632		176693	
12	1.75	110	24.0		9.0	7.0	3	10.20		104633		176694	
16	2.00	110	30.0		12.0	9.0	3	14.00		104634		176695	

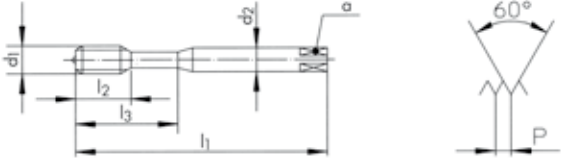
* W320-3
* W320DL-3



									W360-3	W460-3	W360DL-3	W460DL-3
									W360-3  			
W460-3  												
W360DL-3  DL 												
W460DL-3  DL 												
												
$\varnothing d_1$ M	P mm	l_1 mm	l_2 mm	l_3 mm	d_2 mm	α mm			ID	ID	ID	ID
2	0.40	45	7.0		2.8	2.1	2	1.60	104625		176719	
2.5	0.45	50	9.0		2.8	2.1	2	2.05	104626		176720	
3	0.50	56	5.5	18	3.5	2.7	2	2.50	104627		176721	
4	0.70	63	7.5	21	4.5	3.4	2	3.30	104628		176722	
5	0.80	70	9.0	25	6.0	4.9	2	4.20	104629		176723	
6	1.00	80	11.0	30	6.0	4.9	2	5.00	104630		176355	
8	1.25	90	12.5	35	8.0	6.2	2	6.80	104631		176724	
10	1.50	100	14.0	39	10.0	8.0	2	8.50	104624		176725	
12	1.75	110	14.0		9.0	7.0	3	10.20		104640		176726
16	2.00	110	18.0		12.0	9.0	3	14.00		104641		176727

									Z320V-4	Z420V-4	Z320VS-4	Z420VS-4
Z320V-4		V	21	22	23	41	42	51				
Z420V-4		V	21	22	23	41	42	51				
Z320VS-4		VS	21	22	23	24	51	61				
Z420VS-4		VS	21	22	23	24	51	61				
												
									ISO 2 6H	ISO 2 6H	ISO 2 6H	ISO 2 6H
Ø d ₁ M	P mm	l ₁ mm	l ₂ mm	l ₃ mm	d ₂ mm	a mm			ID	ID	ID	ID
*1.6	0.35	40	8.0		2.5	2.1	2	1.25	142671			
*2	0.40	45	8.0		2.8	2.1	2	1.60	111613			
2.5	0.45	50	10.0		2.8	2.1	3	2.05	111455		143683	
2.6	0.45	50	10.0		2.8	2.1	3	2.15	142672			
3	0.50	56	12.0	18	3.5	2.7	3	2.50	104669		104830	
4	0.70	63	14.0	21	4.5	3.4	3	3.30	104670		104831	
5	0.80	70	15.0	25	6.0	4.9	3	4.20	104671		104832	
6	1.00	80	17.0	30	6.0	4.9	3	5.00	104672		104833	
8	1.25	90	20.0	35	8.0	6.2	3	6.80	104673		104834	
10	1.50	100	22.0	39	10.0	8.0	3	8.50	104668		104835	
12	1.75	110	24.0		9.0	7.0	3	10.20		104723		104836
14	2.00	110	28.0		11.0	9.0	3	12.00		142673		143684
16	2.00	110	30.0		12.0	9.0	3	14.00		105068		111569
18	2.50	125	33.0		14.0	11.0	4	15.50		142674		
20	2.50	140	36.0		16.0	12.0	4	17.50		105069		111570
22	2.50	140	36.0		18.0	14.5	4	19.50		146003		
24	3.00	160	39.0		18.0	14.5	4	21.00		142675		
30	3.50	180	45.0		22.0	18.0	4	26.50		142676		

* Z320V-3



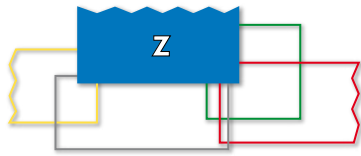

Z360V-3

Z362V-3

Z462V-3

Z360V-3



Z362V-3



Z462V-3

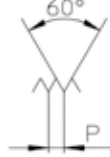
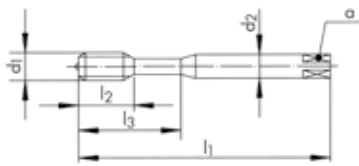

ISO 2
6H

ISO 2
6H

ISO 2
6H

Ø d ₁ M	P mm	l ₁ mm	l ₂ mm	l ₃ mm	d ₂ mm	a mm		
2	0.40	45	7.0		2.8	2.1	2	1.60
2.5	0.45	50	9.0		2.8	2.1	2	2.05
2.6	0.45	50	9.0		2.8	2.1	2	2.15
3	0.50	56	5.5	18	3.5	2.7	3	2.50
3.5	0.60	56	6.5	20	4.0	3.0	3	2.90
4	0.70	63	7.5	21	4.5	3.4	3	3.30
5	0.80	70	9.0	25	6.0	4.9	3	4.20
6	1.00	80	11.0	30	6.0	4.9	3	5.00
8	1.25	90	12.5	35	8.0	6.2	3	6.80
10	1.50	100	14.0	39	10.0	8.0	3	8.50
12	1.75	110	14.0		9.0	7.0	3	10.20
14	2.00	110	14.0		11.0	9.0	3	12.00
16	2.00	110	18.0		12.0	9.0	3	14.00
18	2.50	125	21.0		14.0	11.0	3	15.50
20	2.50	140	24.0		16.0	12.0	3	17.50
22	2.50	140	24.0		18.0	14.5	3	19.50
24	3.00	160	27.0		18.0	14.5	4	21.00
27	3.00	160	27.0		20.0	16.0	4	24.00
30	3.50	180	30.0		22.0	18.0	4	26.50
36	4.00	200	36.0		28.0	22.0	4	32.00
42	4.50	200	40.0		32.0	24.0	4	37.50

ID

ID

ID

104684
104685
104686
104687

104688
104689
104690
104691
104692
104683

104742
104743
104744
104745
104746
104752
104747
104748
104749
104750
104751

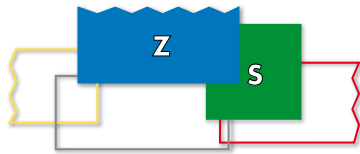

Z362VS-3

R40 VS [22] [23] [24] [51] [61]

Z370VS-3

R45 VS CLASSIC SYNCHRO [15] [22] [23] [24] [51] [52] [61]

Z373VS-3

R45 VS CLASSIC SYNCHRO [15] [22] [23] [24] [51] [52] [61]

Z362VS-3	Z370VS-3	Z370VS-3	Z373VS-3
----------	----------	----------	----------



	PM	PM	PM

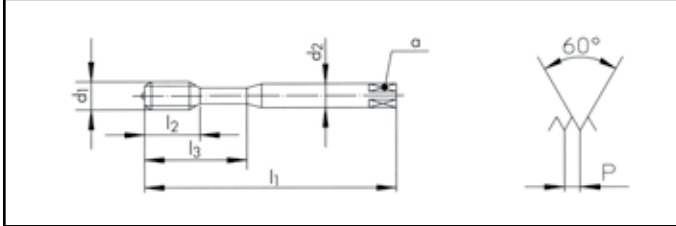









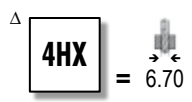

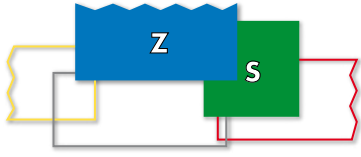





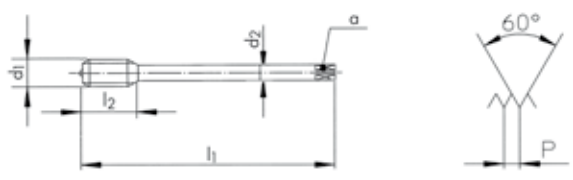

6HX	6HX	4HX	6HX

∅ d ₁ M	P mm	l ₁ mm	l ₂ mm	l ₃ mm	d ₂ mm	a mm			ID
*3	0.50	56	5.5	18	3.5	2.7	3	2.50	111504
4	0.70	63	7.5	21	4.5	3.4	3	3.30	111505
5	0.80	70	9.0	25	6.0	4.9	3	4.20	111506
6	1.00	80	11.0	30	6.0	4.9	3	5.00	111507
8	1.25	90	12.5	35	8.0	6.2	3	6.80	111508
10	1.50	100	14.0	39	10.0	8.0	3	8.50	111509

* **Z360VS-3**

∅ d ₁ M	P mm	l ₁ mm	l ₂ mm	l ₃ mm	d ₂ h6 mm	a mm			ID	ID	ID
3	0.50	56	5.5	18	3.5(h9)	2.7	3	2.50	162776	165324	165236
4	0.70	63	7.5	21	4.5(h9)	3.4	3	3.30	162777	165325	165237
5	0.80	70	9.0	25	6.0	4.9	3	4.20	162778	165326	165238
6	1.00	80	11.0	30	6.0	4.9	3	5.00	162779	165327	165239
8	1.25	90	12.5	35	8.0	6.2	3	6.80	162780	165328	165240
10	1.50	100	14.0	39	10.0	8.0	3	8.50	162781	165438	165241



									Z462VS-3	Z470VS-3	Z473VS-3	
<p>Z462VS-3</p>  												
<p>Z470VS-3</p>  												
<p>Z473VS-3</p>  												
												
												
												
												
$\varnothing d_1$ M	P mm	l_1 mm	l_2 mm	d_2 mm	α mm			ID				
12	1.75	110	14.0	9.0	7.0	4	10.20	111510				
14	2.00	110	14.0	11.0	9.0	4	12.00	* 148169				
16	2.00	110	18.0	12.0	9.0	4	14.00	111511				
20	2.50	140	24.0	16.0	12.0	4	17.50	111512				
24	3.00	160	27.0	18.0	14.5	4	21.00	* 111620				
$\varnothing d_1$ M	P mm	l_1 mm	l_2 mm	d_2 h6 mm	α mm			ID	ID			
12	1.75	110	14.0	*10.0	*8.0	4	10.20	162782	165242			
14	2.00	110	14.0	*12.0	*9.0	4	12.00	162783	* 165243			
16	2.00	110	18.0	12.0	9.0	4	14.00	162784	165244			
18	2.50	125	21.0	14.0	11.0	4	15.50	170643				
20	2.50	140	24.0	16.0	12.0	4	17.50	162785	165234			
22	2.50	140	24.0	16.0	12.0	4	19.50	175190				
24	3.00	160	27.0	16.0	12.0	4	21.00	162786	165235			
* Norme DC / * DC Norm / * Norma DC												

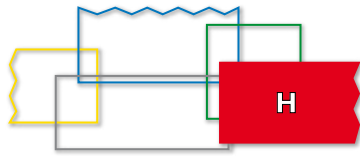

H320-4	H320TC-4		
--------	----------	--	--



H320-4





H320TC-4

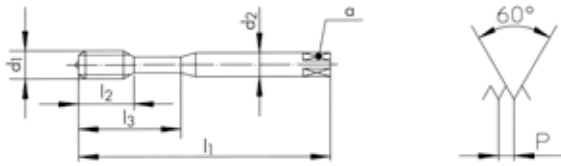
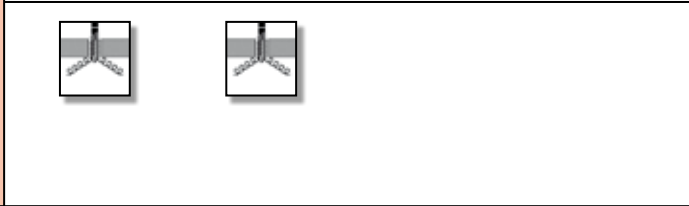

TiCN



$\varnothing d_1$ M	P mm	l_1 mm	l_2 mm	l_3 mm	d_2 mm	a mm			ID	ID
2	0.40	45	8.0		2.8	2.1	2	1.60	101206	151836
2.2	0.45	45	9.0		2.8	2.1	2	1.75	111801	
2.5	0.45	50	10.0		2.8	2.1	3	2.05	101207	148603
3	0.50	56	12.0	18	3.5	2.7	3	2.50	101209	111836
3.5	0.60	56	13.0	20	4.0	3.0	3	2.90	101210	
4	0.70	63	14.0	21	4.5	3.4	3	3.30	101211	111502
4.5	0.75	70	15.0	25	6.0	4.9	3	3.75	101212	
5	0.80	70	15.0	25	6.0	4.9	3	4.20	101213	111458
6	1.00	80	17.0	30	6.0	4.9	3	5.00	101215	111456
8	1.25	90	20.0	35	8.0	6.2	3	6.80	101218	111453
10	1.50	100	22.0	39	10.0	8.0	3	8.50	101205	110911

									H420-4	H420TC-4		
H420-4												
H420TC-4	TiCN											
Ø d ₁ M	P mm	l ₁ mm	l ₂ mm	d ₂ mm	α mm				ID	ID		
12	1.75	110	24.0	9.0	7.0	4	10.20		101275	110912		
14	2.00	110	28.0	11.0	9.0	4	12.00		101277			
16	2.00	110	30.0	12.0	9.0	4	14.00		101279	111612		
18	2.50	125	33.0	14.0	11.0	4	15.50		101281			
20	2.50	140	36.0	16.0	12.0	4	17.50		101284			
24	3.00	160	39.0	18.0	14.5	4	21.00		101286			
27	3.00	160	42.0	20.0	16.0	4	24.00		101287			
30	3.50	180	45.0	22.0	18.0	4	26.50		101288			
36	4.00	200	51.0	28.0	22.0	4	32.00		101289			

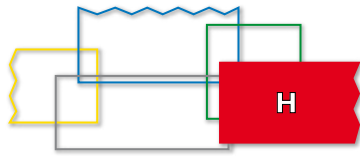

H350-3



H350TC-3



H350-3

H350-3

H350TC-3

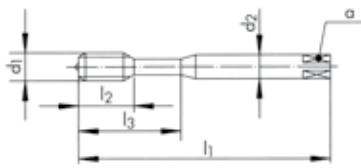

$\varnothing d_1$ M	P mm	l_1 mm	l_2 mm	l_3 mm	d_2 mm	a mm		$6H$ $\rightarrow \leftarrow$
2	0.40	45	7.0		2.8	2.1	2	1.60
2.5	0.45	50	9.0		2.8	2.1	3	2.05
3	0.50	56	5.5	18	3.5	2.7	3	2.50
3.5	0.60	56	6.5	20	4.0	3.0	3	2.90
4	0.70	63	7.5	21	4.5	3.4	3	3.30
4.5	0.75	70	9.0	25	6.0	4.9	3	3.75
5	0.80	70	9.0	25	6.0	4.9	3	4.20
6	1.00	80	11.0	30	6.0	4.9	3	5.00
8	1.25	90	12.5	35	8.0	6.2	3	6.80
10	1.50	100	14.0	39	10.0	8.0	3	8.50

ID

ID

$6H$
+ mm

ID

101238

146451

101239

144957

101242

101241

0.020

111835

101243

101245

101244

0.022

111607

101246

101248

101247

0.024

111610

101251

101250

0.026

111500

101255

101254

0.028

110963

101237

101236

0.032

111454

M ISO DIN 13

≤ Ø 25.4 > Ø 25.4

PM **HSSE**



DIN 376

									H450-3	H450-3	H450TC-3	
H450-3												
H450TC-3	TiCN											
									ISO 2 6H	ISO 3 6G	ISO 2 6H	
Ø d ₁ M	P mm	l ₁ mm	l ₂ mm	d ₂ mm	α mm				ID	ID ^{6H} + mm	ID	
12	1.75	110	14.0	9.0	7.0	4	10.20		101305	101304	0.034	111501
14	2.00	110	14.0	11.0	9.0	4	12.00		101307			
16	2.00	110	18.0	12.0	9.0	4	14.00		101309			111605
18	2.50	125	21.0	14.0	11.0	4	15.50		101311			
20	2.50	140	24.0	16.0	12.0	4	17.50		101313			
22	2.50	140	24.0	18.0	14.5	4	19.50		101315			
24	3.00	160	27.0	18.0	14.5	4	21.00		101318			
27	3.00	160	27.0	20.0	16.0	4	24.00		101320			
30	3.50	180	30.0	22.0	18.0	4	26.50		101323			
36	4.00	200	36.0	28.0	22.0	4	32.00		101324			
42	4.50	200	40.0	32.0	24.0	4	37.50		101325			

										S320VS-4	S320VS-4	S420VS-4	
S320VS-4		VS											
S420VS-4		VS											
										6HX	4HX	6HX	
$\varnothing d_1$ M	P mm	l_1 mm	l_2 mm	l_3 mm	d_2 mm	a mm				ID	ID	ID	
3	0.50	56	12.0	18	3.5	2.7	3		2.50	111596	* 165318		
4	0.70	63	14.0	21	4.5	3.4	3		3.30	111597	165319		
5	0.80	70	15.0	25	6.0	4.9	3		4.20	111598	165320		
6	1.00	80	17.0	30	6.0	4.9	3		5.00	111599	165321		
8	1.25	90	20.0	35	8.0	6.2	3	Δ	6.80	111600	165322		
10	1.50	100	22.0	39	10.0	8.0	3		8.50	111601	165323		
12	1.75	110	24.0		9.0	7.0	4		10.20			111602	
14	2.00	110	30.0		11.0	9.0	4		12.50			* 162537	
16	2.00	110	30.0		12.0	9.0	4		14.00			111603	
20	2.50	140	36.0		16.0	12.0	4		17.50			111604	

Δ **4HX** = = 6.70

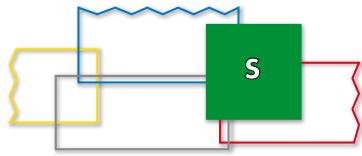

S360VS-3	S460VS-3	SA390-3	SA390-3
----------	----------	---------	---------



S360VS-3



13	15	24	S2
----	----	----	----

S460VS-3



13	15	24	S2
----	----	----	----

aero

SA390-3



S3

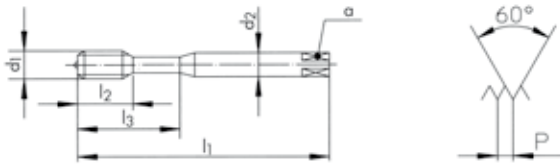

6HX	6HX	4HX	6HX

∅ d ₁ M	P mm	l ₁ mm	l ₂ mm	l ₃ mm	d ₂ mm	α mm		
3	0.50	56	5.5	18	3.5	2.7	3	2.50
4	0.70	63	7.5	21	4.5	3.4	3	3.30
5	0.80	70	9.0	25	6.0	4.9	3	4.20
6	1.00	80	11.0	30	6.0	4.9	3	5.00
8	1.25	90	12.5	35	8.0	6.2	3	6.80
10	1.50	100	14.0	39	10.0	8.0	3	8.50
12	1.75	110	14.0		9.0	7.0	4	10.20
14	2.00	110	14.0		11.0	9.0	4	12.00
16	2.00	110	18.0		12.0	9.0	4	14.00
20	2.50	140	24.0		16.0	12.0	4	17.50
24	3.00	160	27.0		18.0	14.5	4	21.00













ID	ID
111513	
111514	
111515	
111516	
111517	
111518	
	111519
	148171
	111520
	111521
	111606

∅ d ₁ M	P mm	l ₁ mm	l ₂ mm	d ₂ mm	α mm		
4	0.70	63	14.0	4.5	3.4	3	3.30
5	0.80	70	15.0	6.0	4.9	3	4.20
6	1.00	80	20.0	6.0	4.9	3	5.00
8	1.25	90	25.0	8.0	6.2	3	Δ 6.80
10	1.50	100	30.0	10.0	8.0	3	8.50
12	1.75	110	35.0	12.0	9.0	4	10.20
14	2.00	110	40.0	16.0	12.0	4	12.00
16	2.00	110	40.0	16.0	12.0	4	14.00

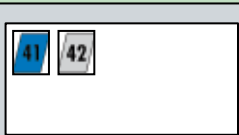
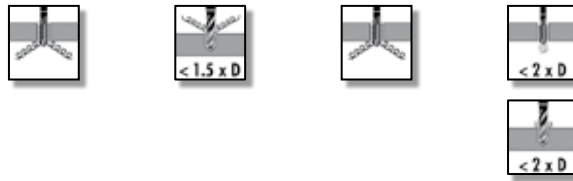
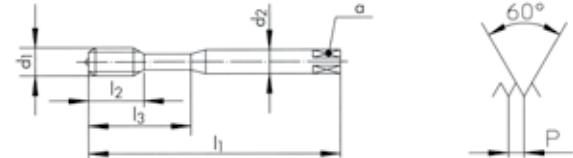
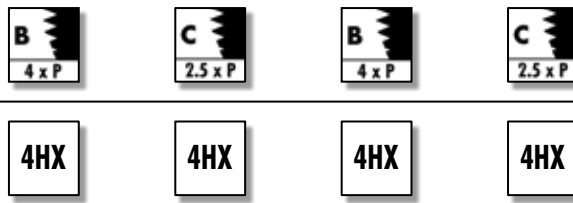
ID	ID
149673	149674
149693	149694
149707	149708
149736	149737
149754	149755
	149775
	* 149792
	* 149816

Δ **4HX** = = 6.70

aero

										SA320-4	SA350-3	TL320VS-4	TL351VS-3
   													
 													
													
$\varnothing d_1$	P	l_1	l_2	l_3	d_2	α				ID	ID	ID	ID
M	mm	mm	mm	mm	mm	mm			$\rightarrow \leftarrow$				
3	0.50	56	12.0		3.5	2.7	3		2.50	147975	147987	152006	152012
4	0.70	63	14.0		4.5	3.4	3		3.30	147976	147988	152007	152013
5	0.80	70	15.0		6.0	4.9	3		4.20	147977	147989	152008	152014
6	1.00	80	15.0	23	6.0	4.9	3		5.00	147978	147990	152009	152015
8	1.25	90	18.0	29	8.0	6.2	3		6.70	147979	147991	152010	152016
10	1.50	100	20.0	33	10.0	8.0	3		8.50	147980	147992	152011	152017
													
$\varnothing d_1$	P	l_1	l_2	l_3	d_2	α				ID	ID	ID	ID
M	mm	mm	mm	mm	mm	mm			$\rightarrow \leftarrow$				
3	0.50	56	12.0		3.5	2.7	3		2.50	147981	147993	148001	148000
4	0.70	63	14.0		4.5	3.4	3		3.30	147982	147994	148003	148002
5	0.80	70	15.0		6.0	4.9	3		4.20	147983	147995	148007	148006
6	1.00	80	15.0	23	6.0	4.9	3		5.00	147984	147996	148011	148010
8	1.25	90	18.0	29	8.0	6.2	3		6.80	147985	147997	148020	148018
10	1.50	100	20.0	33	10.0	8.0	3		8.50	147986	147998	148027	148025

aero

SA420-4 SA450-3 TL420VS-4 TL451VS-3



SA420-4



SA450-3



TL420VS-4



VS

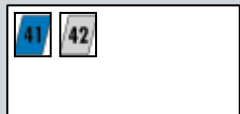

TL451VS-3



VS

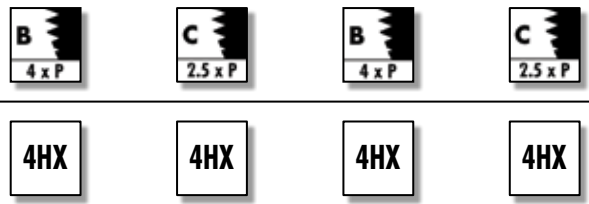
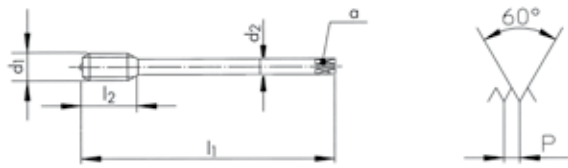
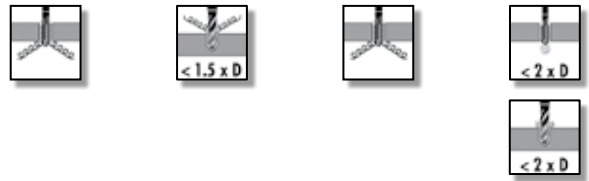
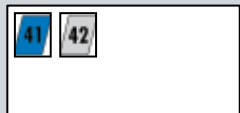

4HX 4HX 4HX 4HX

$\varnothing d_1$ M	P mm	l_1 mm	l_2 mm	d_2 mm	α mm		
12	1.75	110	24.0	9.0	7.0	4	10.20
14	2.00	110	28.0	11.0	9.0	4	12.00
16	2.00	110	30.0	12.0	9.0	4	14.00

ID	ID	ID	ID
148096	152189	152192	152195
* 152187			
* 152188	* 152191		152197

6HX 6HX 6HX 6HX

$\varnothing d_1$ M	P mm	l_1 mm	l_2 mm	d_2 mm	α mm		
12	1.75	110	24.0	9.0	7.0	4	10.20
14	2.00	110	28.0	11.0	9.0	4	12.00
16	2.00	110	30.0	12.0	9.0	4	14.00

ID	ID	ID	ID
152198	152201	152204	148028
* 152199	* 152202	* 152205	152207
* 152200	152203	* 152206	148029

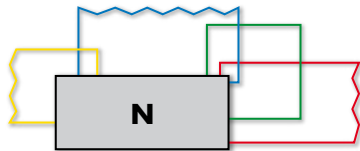
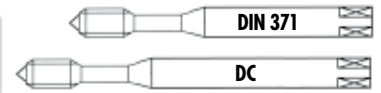

GG350NV-3 GG350TC-3 GG353TC-3 GG550NV-3



GG350NV-3

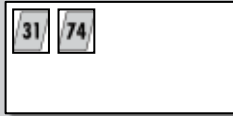

GG350TC-3

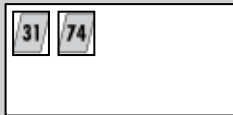

GG353TC-3

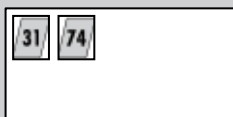

GG550NV-3

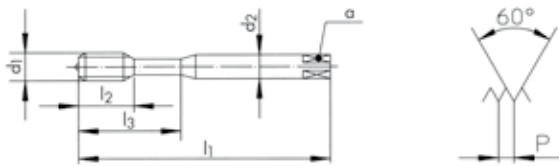
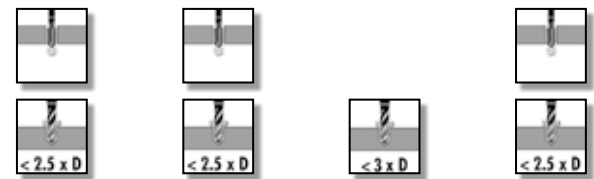
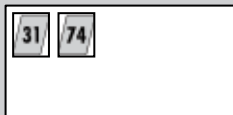

6HX 6HX 6HX 6HX

$\varnothing d_1$ M	P mm	l_1 mm	l_2 mm	l_3 mm	d_2 mm	a mm		
3	0.50	56	12.0	18	3.5	2.7	3	2.50
4	0.70	63	14.0	21	4.5	3.4	3	3.30
5	0.80	70	15.0	25	6.0	4.9	3	4.20
6	1.00	80	17.0	30	6.0	4.9	3	5.00
8	1.25	90	20.0	35	8.0	6.2	4	6.80
10	1.50	100	22.0	39	10.0	8.0	4	8.50

ID ID

101172	101178
101173	101179
101174	101180
101175	101181
101076	101182
101171	101177

$\varnothing d_1$ M	P mm	l_1 mm	l_2 mm	l_3 mm	d_2 h6 mm	a mm		
5	0.80	70	15.0	25	6.0	4.9	3	4.20
6	1.00	80	17.0	30	6.0	4.9	3	5.00
8	1.25	90	20.0	35	8.0	6.2	4	6.80
10	1.50	100	22.0	39	10.0	8.0	4	8.50

ID

144947
147710
147711
146708

$\varnothing d_1$ M	P mm	l_1 mm	l_2 mm	l_3 mm	d_2 mm	a mm		
4	0.70	112	14.0	21	4.5	3.4	3	3.30
5	0.80	125	15.0	25	6.0	4.9	3	4.20
6	1.00	125	17.0	30	6.0	4.9	3	5.00

ID

101196
101197
101198

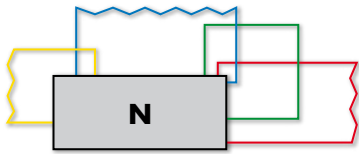
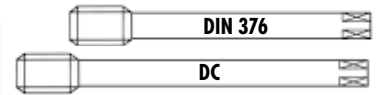

GG450NV-3				
GG450TC-3				
GG453TC-3				
GG650NV-3				

GG450NV-3	GG450TC-3	GG453TC-3	GG650NV-3
-----------	-----------	-----------	-----------

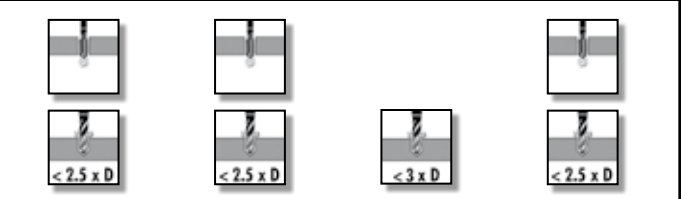
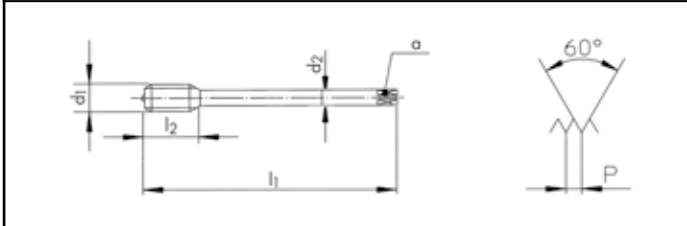

6HX	6HX	6HX	6HX

∅ d ₁ M	P mm	l ₁ mm	l ₂ mm	d ₂ mm	a mm		
8	1.25	90	20.0	6.0	4.9	4	6.80
10	1.50	100	22.0	7.0	5.5	4	8.50
12	1.75	110	24.0	9.0	7.0	4	10.20
14	2.00	110	28.0	11.0	9.0	4	12.00
16	2.00	110	30.0	12.0	9.0	4	14.00
20	2.50	140	36.0	16.0	12.0	4	17.50
24	3.00	160	39.0	18.0	14.5	4	21.00

ID	ID
101189	101194
101183	101195
101184	101190
101185	101191
101186	101192
101187	101193
101188	

∅ d ₁ M	P mm	l ₁ mm	l ₂ mm	d ₂ h6 mm	a mm		
12	1.75	110	24.0	*10.0	*8.0	4	10.20
16	2.00	110	30.0	12.0	9.0	4	14.00

* Norme DC / * DC Norm / * Norma DC

ID
146707
162796

∅ d ₁ M	P mm	l ₁ mm	l ₂ mm	d ₂ mm	a mm		
8	1.25	140	20.0	6.0	4.9	4	6.80
10	1.50	160	22.0	7.0	5.5	4	8.50
12	1.75	180	24.0	9.0	7.0	4	10.20
16	2.00	200	30.0	12.0	9.0	4	14.00
20	2.50	224	36.0	16.0	12.0	4	17.50

ID
101203
101199
101200
101201
101202



Uniquement pour taraudage synchrone
Nur für Synchrobearbeitung
Only for rigid tapping
Solo per maschiatura sincrona
Solo para rosado sincronizado

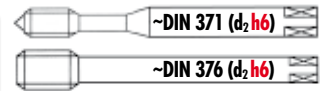

RTS Rigid Tapping Synchro

RTS320VS-4



11	12	13	14
15	21	22	31
32	61	63	72
73	74		

RTS420VS-4



RTS323VS-4



11	12	13	14
15	21	22	31
32	61	63	72
73	74		

RTS423VS-4



RTS320VS-4

RTS420VS-4

RTS323VS-4

RTS423VS-4

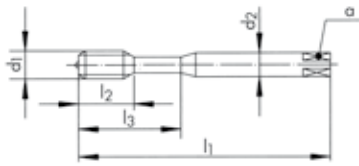

∅ d ₁ M	P mm	l ₁ mm	l ₂ mm	l ₃ mm	d ₂ h ₆ mm	a mm		
*2	0.40	45	8.0		2.8(h9)	2.1	2	1.60
2.5	0.45	50	10.0		2.8(h9)	2.1	3	2.05
3	0.50	56	5.5	18	3.5(h9)	2.7	3	2.50
4	0.70	63	7.5	21	4.5(h9)	3.4	3	3.30
5	0.80	70	9.0	25	6.0	4.9	3	4.20
6	1.00	80	11.0	30	6.0	4.9	3	5.00
8	1.25	90	12.5	35	8.0	6.2	3	6.80
10	1.50	100	14.0	39	10.0	8.0	3	8.50
12	1.75	110	14.0		*10.0	*8.0	3	10.20
14	2.00	110	14.0		*12.0	*9.0	3	12.00
16	2.00	110	18.0		12.0	9.0	3	14.00
20	2.50	140	24.0		16.0	12.0	4	17.50
24	3.00	160	27.0		16.0	12.0	4	21.00

ID

ID

ID

ID

143532

143534

150601

150603

150605

150606

150610

150611

150620

150621

150635

150636

151863

151864

162535

150670

150671

150679

162787

* Norme DC / * DC Norm / * Norma DC

* RTS320VS-3



sur demande
auf Anfrage
on request
su richiesta
sobre pedido



Uniquement pour taraudage synchrone
Nur für Synchrobearbeitung
Only for rigid tapping
Solo per maschiatura sincrona
Solo para roscado sincronizado

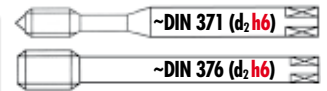

RTS Rigid Tapping Synchro

RTS362VS-3



RTS462VS-3



RTS365VS-3



RTS465VS-3



RTS362VS-3 RTS462VS-3 RTS365VS-3 RTS465VS-3

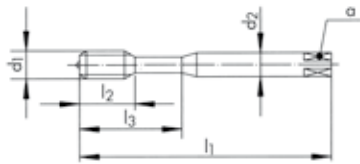

Ø d ₁ M	P mm	l ₁ mm	l ₂ mm	l ₃ mm	d ₂ h6 mm	α mm		
*2	0.40	45	7.0		2.8 (h9)	2.1	3	1.60
*2.5	0.45	50	9.0		2.8 (h9)	2.1	3	2.05
3	0.50	56	5.5	18	3.5 (h9)	2.7	3	2.50
4	0.70	63	7.5	21	4.5 (h9)	3.4	3	3.30
5	0.80	70	9.0	25	6.0	4.9	3	4.20
6	1.00	80	11.0	30	6.0	4.9	3	5.00
8	1.25	90	12.5	35	8.0	6.2	3	6.80
10	1.50	100	14.0	39	10.0	8.0	3	8.50
12	1.75	110	14.0		*10.0	*8.0	3	10.20
14	2.00	110	14.0		*12.0	*9.0	3	12.00
16	2.00	110	18.0		12.0	9.0	3	14.00
20	2.50	140	24.0		16.0	12.0	4	17.50
24	3.00	160	27.0		16.0	12.0	4	21.00

* Norme DC / * DC Norm / * Norma DC

* RTS360VS-3



sur demande
auf Anfrage
on request
su richiesta
sobre pedido



Uniquement pour taraudage synchrone
Nur für Synchrobearbeitung
Only for rigid tapping
Solo per maschiatura sincrona
Solo para roscado sincronizado



RTS Rigid Tapping Synchro

RTS362VS-5



11	12	13	14
15	21	22	31
32	61	63	72
73	74		

RTS365VS-5



11	12	13	14
15	21	22	31
32	61	63	72
73	74		

RTS362VS-3



11	12	13	14
15	21	22	31
32	61	63	72
73	74		

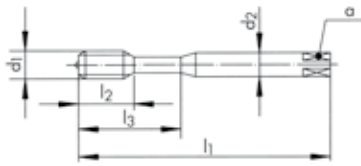

RTS362VS-5

RTS365VS-5

RTS362VS-3



∅ d ₁ M	P mm	l ₁ mm	l ₂ mm	l ₃ mm	d ₂ h6 mm	a mm		
3	0.50	56	5.5	18	3.5 (h9)	2.7	3	2.50
4	0.70	63	7.5	21	4.5 (h9)	3.4	3	3.30
5	0.80	70	9.0	25	6.0	4.9	3	4.20
6	1.00	80	11.0	30	6.0	4.9	3	5.00
8	1.25	90	12.5	35	8.0	6.2	3	6.80
10	1.50	100	14.0	39	10.0	8.0	3	8.50

ID

ID

157648

157650

157652

162791

158074

151803

158076

157821

153286

157823

∅ d ₁ M	P mm	l ₁ mm	l ₂ mm	l ₃ mm	d ₂ h6 mm	a mm			6H
3	0.50	56	5.5	18	3.5 (h9)	2.7	3	2.50	
4	0.70	63	7.5	21	4.5 (h9)	3.4	3	3.35	
5	0.80	70	9.0	25	6.0	4.9	3	4.25	
6	1.00	80	11.0	30	6.0	4.9	3	5.00	
8	1.25	90	12.5	35	8.0	6.2	3	6.80	
10	1.50	100	14.0	39	10.0	8.0	3	8.50	

ID

6H
+ mm

162797 0.020

162798 0.022

162799 0.024

162800 0.026

162801 0.028

162802 0.032



sur demande
auf Anfrage
on request
su richiesta
sobre pedido



Uniquement pour taraudage synchrone
Nur für Synchrobearbeitung
Only for rigid tapping
Solo per maschiatura sincrona
Solo para roscado sincronizado

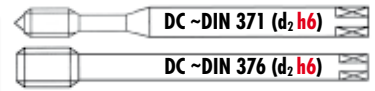

RTS Rigid Tapping Synchro

RTS523VS-4



11	12	13	14
15	21	22	31
32	61	63	72
73	74		

RTS623VS-4



RTS565VS-3



11	12	13	14
15	21	22	31
32	61	63	72
73	74		

RTS665VS-3



RTS523VS-4



ID

RTS623VS-4



ID

RTS565VS-3

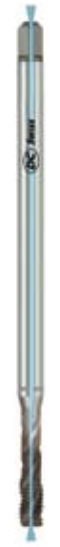

ID

RTS665VS-3



ID

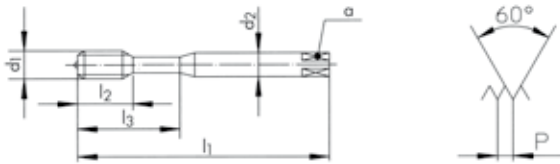

∅ d ₁ M	P mm	l ₁ mm	l ₂ mm	l ₃ mm	d ₂ h ₆ mm	α mm		
5	0.80	125	9.0	25	6.0	4.9	3	4.20
6	1.00	125	11.0	30	6.0	4.9	3	5.00
8	1.25	140	12.5	35	8.0	6.2	3	6.80
10	1.50	160	14.0	39	10.0	8.0	3	8.50
12	1.75	180	14.0		*10.0	*8.0	3	10.20
16	2.00	200	18.0		12.0	9.0	3	14.00

* Norme DC / * DC Norm / * Norma DC

∅ d ₁ M	P mm	l ₁ mm	l ₂ mm	l ₃ mm	d ₂ h ₆ mm	α mm		
6	1.00	125	11.0	30	6.0	4.9	3	5.00
8	1.25	140	12.5	35	8.0	6.2	3	6.80
10	1.50	160	14.0	39	10.0	8.0	3	8.50
12	1.75	180	14.0		*10.0	*8.0	3	10.20
16	2.00	200	18.0		12.0	9.0	3	14.00

* Norme DC / * DC Norm / * Norma DC



sur demande
auf Anfrage
on request
su richiesta
sobre pedido

K

K313TC-3

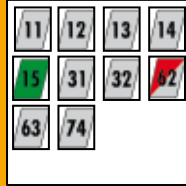

K413TC-3

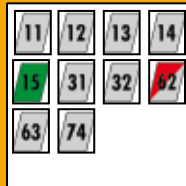

K313TC-3

K413TC-3



6HX

6HX

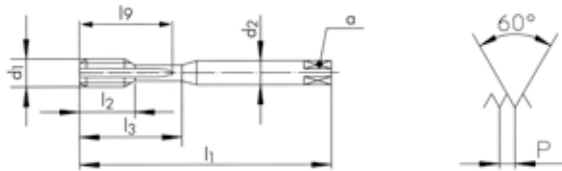

$\varnothing d_1$ M	P mm	l_1 mm	l_2 mm	l_3 mm	l_9 mm	d_2 mm	a mm		
6	1.00	80	17.0	30	28.0	6.0	4.9	3	5.00
8	1.25	90	20.0	35	33.0	8.0	6.2	3	6.80
10	1.50	100	22.0	39	37.0	10.0	8.0	3	8.50
12	1.75	110	24.0	42.0	42.0	9.0	7.0	3	10.20
14	2.00	110	28.0	49.0	49.0	11.0	9.0	3	12.00
16	2.00	110	30.0	56.0	56.0	12.0	9.0	4	14.00
20	2.50	140	36.0	70.0	70.0	16.0	12.0	5	17.50
24	3.00	160	39.0	84.0	84.0	18.0	14.5	5	21.00

ID

ID

170766

170769

170772

165838









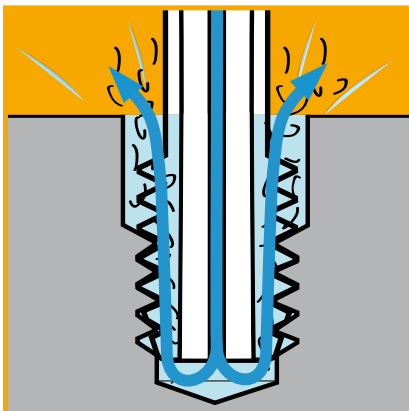







170778



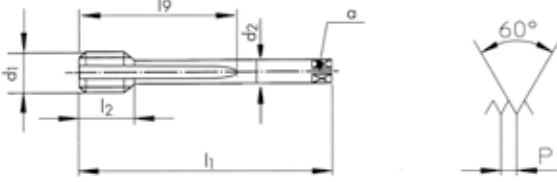

170783

170786

170775

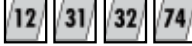

K									K613TC-3	K613VS-3														
<div style="display: flex; justify-content: space-between;"> <div style="width: 45%;"> <p>K613TC-3</p>    <p>>20 bar</p>  </div> <div style="width: 45%;"> <table border="1" style="border-collapse: collapse; text-align: center;"> <tr><td>11</td><td>12</td><td>13</td><td>14</td></tr> <tr><td>15</td><td>31</td><td>32</td><td>62</td></tr> <tr><td>63</td><td>74</td><td></td><td></td></tr> </table> </div> </div>									11	12	13	14	15	31	32	62	63	74						
11	12	13	14																					
15	31	32	62																					
63	74																							
<div style="display: flex; justify-content: space-between;"> <div style="width: 45%;"> <p>K613VS-3</p>    <p>>20 bar</p>  </div> <div style="width: 45%;"> <table border="1" style="border-collapse: collapse; text-align: center;"> <tr><td>11</td><td>12</td><td>13</td><td>14</td></tr> <tr><td>15</td><td>31</td><td>32</td><td>62</td></tr> <tr><td>63</td><td>74</td><td></td><td></td></tr> </table> </div> </div>									11	12	13	14	15	31	32	62	63	74			 <p>NEW</p>			
11	12	13	14																					
15	31	32	62																					
63	74																							
																								
																								
$\varnothing d_1$	P	l_1	l_2	l_3	d_2	α			ID	ID														
M	mm	mm	mm	mm	mm	mm																		
6	1.00	110	17.0	30	4.5	3.4	3	5.00	170646	172699														
8	1.25	110	20.0	40	6.0	4.9	3	6.80	170649	172700														
10	1.50	125	22.0	50	7.0	5.5	3	8.50	170652	172701														
12	1.75	140	24.0	60	9.0	7.0	3	10.20	167982	172702														
14	2.00	140	28.0	70	11.0	9.0	3	12.00	167983															
16	2.00	160	30.0	80	12.0	9.0	4	14.00	167984	170573														
20	2.50	180	36.0	100	16.0	12.0	5	17.50	167985	170576														
24	3.00	200	39.0	120	18.0	14.5	5	21.00	167986	172704														
27	3.00	225	42.0	135	20.0	16.0	5	24.00	167987															
30	3.50	250	45.0	150	22.0	18.0	5	26.50	165542															
33	3.50	280	48.0	165	25.0	20.0	5	29.50	167988															
36	4.00	300	51.0	180	28.0	22.0	6	32.00	167989															
39	4.00	300	55.0	195	32.0	24.0	6	35.00	167990															
42	4.50	355	55.0	210	32.0	24.0	6	37.50	167999															

Vc (m/min)				
	M6 - M10	M12 - M16	M20 - M30	M33 - M42
	32	28	22	18
	30	25	20	15
	24	20	16	12
	15	12	8	6
	35	30	25	20

FS FORMING

FS380VS-5



FS380VS-3



FS380VS-5

FS380VS-3

FS380VS-3

FS380VS-3

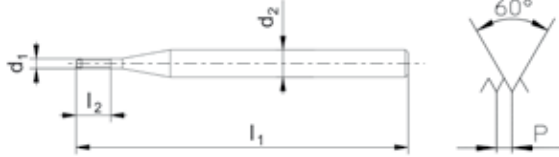

6HX

6HX

6HX

6GX

$\varnothing d_1$ M	P mm	l_1 mm	l_2 mm	d_2 mm	a mm	4HX Tol. → ← 6HX	ID	ID	ID	ID 6H + mm
1	0.25	40	3.0	2.5		0.88 +0.02	157171	173452		
1.2	0.25	40	3.6	2.5		1.08 +0.02	157172	173455		
1.4	0.30	40	4.2	2.5		1.25 +0.02	157173	173458		
1.6	0.35	40	4.8	2.5		1.45 +0.02	157174	169779		
1.7	0.35	40	5.1	2.5		1.55 +0.02		169782		
1.8	0.35	40	5.4	2.5		1.65 +0.02	157175	169785		
2	0.40	45	8.0	2.8	2.1	1.80 +0.02			157176	157180 0.019
2.5	0.45	50	10.0	2.8	2.1	2.30 +0.02			157178	157181 0.020
2.6	0.45	50	10.0	2.8	2.1	2.40 +0.02			157179	

≤ M1.5 4HX

FS FORMING

FS380DL-5



11	12	13	14
21	22	23	24
41	51	61	63
71	72	73	

FS380DL-3



11	12	13	14
21	22	23	24
41	51	61	63
71	72	73	

FS380DL-5 FS380DL-3 FS380DL-3 FS380DL-3



NEW **NEW** **NEW** **NEW**

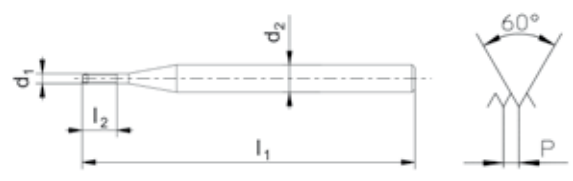

6HX **6HX** **6HX** **6GX**

$\varnothing d_1$ M	P mm	l_1 mm	l_2 mm	d_2 mm	α mm	4HX Tol. 6HX
1	0.25	40	3.0	2.5		0.88 +0.02
1.2	0.25	40	3.6	2.5		1.08 +0.02
1.4	0.30	40	4.2	2.5		1.25 +0.02
1.6	0.35	40	4.8	2.5		1.45 +0.02
1.7	0.35	40	5.1	2.5		1.55 +0.02
1.8	0.35	40	5.4	2.5		1.65 +0.02
2	0.40	45	8.0	2.8	2.1	1.80 +0.02
2.5	0.45	50	10.0	2.8	2.1	2.30 +0.02
2.6	0.45	50	10.0	2.8	2.1	2.40 +0.02

ID	ID	ID	ID	6H + mm
172839	173461			
172840	173464			
172841	173467			
170585	170916			
	172843			
172842	172844			
		158814		172849 0.019
		172845		173246 0.020
		172846		

≤ M1.5 **4HX**

FPS FORMING

FPS380CN-3		CrN	63 71 72 73
FPS381CN-3		CrN	63 71 72 73
FPS380VS-3		VS	11 12 13 14 15 21 24 63
FPS381VS-3		VS	11 12 13 14 15 21 24 63

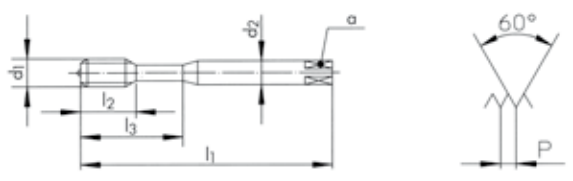

2.5 x P	2.5 x P	2.5 x P	2.5 x P
6HX	6HX	6HX	6HX

$\varnothing d_1$ M	P mm	l_1 mm	l_2 mm	l_3 mm	d_2 mm	a mm	6HX Tol. → ←
3	0.50	56	12.0	18	3.5	2.7	2.80 + 0.03
3.5	0.60	56	13.0	20	4.0	3.0	3.25 + 0.03
4	0.70	63	14.0	21	4.5	3.4	3.70 + 0.03
5	0.80	70	15.0	25	6.0	4.9	4.65 + 0.03
6	1.00	80	17.0	30	6.0	4.9	5.55 + 0.05
8	1.25	90	20.0	35	8.0	6.2	7.40 + 0.05
10	1.50	100	22.0	39	10.0	8.0	9.30 + 0.05

ID	ID	ID	ID
166613	166615	166614	166616
166619	166621	166620	166622
166626	166628	166627	166629
166634	166636	166635	166637
166643	166645	166644	166646
166653	166655	166654	166656
166663	166665	166664	166666

$\varnothing d_1$ M	P mm	l_1 mm	l_2 mm	l_3 mm	d_2 mm	a mm	6HX Tol. → ←
3	0.50	56	12.0	18	3.5	2.7	2.80 + 0.03
3.5	0.60	56	13.0	20	4.0	3.0	3.25 + 0.03
4	0.70	63	14.0	21	4.5	3.4	3.70 + 0.03
5	0.80	70	15.0	25	6.0	4.9	4.65 + 0.03
6	1.00	80	17.0	30	6.0	4.9	5.55 + 0.05
8	1.25	90	20.0	35	8.0	6.2	7.40 + 0.05
10	1.50	100	22.0	39	10.0	8.0	9.30 + 0.05

ID 6H + mm	ID 6H + mm
166697 0.020	166617 0.020
166687 0.021	166623 0.021
166688 0.022	166630 0.022
166689 0.024	166638 0.024
166686 0.026	166647 0.026
166740 0.028	166657 0.028
166739 0.032	166667 0.032

FPS FORMING

FPS481VS-3



FPS581VS-3



FPS681VS-3



FPS481VS-3

FPS581VS-3

FPS681VS-3



NEW

NEW



6HX

6HX

6HX

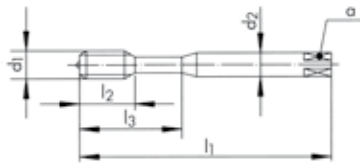

$\varnothing d_1$ M	P mm	l_1 mm	l_2 mm	d_2 mm	α mm	6HX Tol.	
12	1.75	110	24.0	9.0	7.0	11.20	+ 0.05
14	2.00	110	28.0	11.0	9.0	13.10	+ 0.05
16	2.00	110	30.0	12.0	9.0	15.10	+ 0.05
20	2.50	140	36.0	16.0	12.0	18.85	+ 0.05

ID

166673
166678
166683
168713

$\varnothing d_1$ M	P mm	l_1 mm	l_2 mm	l_3 mm	d_2 mm	α mm	6HX Tol.	
3	0.50	100	12.0	18	3.5	2.7	2.80	+ 0.03
4	0.70	125	14.0	21	4.5	3.4	3.70	+ 0.03
5	0.80	140	15.0	25	6.0	4.9	4.65	+ 0.03
6	1.00	160	17.0	30	6.0	4.9	5.55	+ 0.05
8	1.25	180	20.0	35	8.0	6.2	7.40	+ 0.05
10	1.50	200	22.0	39	10.0	8.0	9.30	+ 0.05
12	1.75	224	24.0		9.0	7.0	11.20	+ 0.05

ID

ID

172824
172826
172828
172830
172832
172834

172836

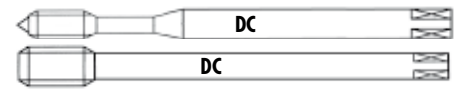
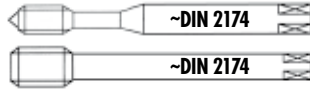

FPS FORMING

FPS384VS-3 FPS484VS-3 FPS584VS-3 FPS684VS-3

FPS384VS-3		VS	<table border="1"> <tr><td>11</td><td>12</td><td>13</td><td>14</td></tr> <tr><td>15</td><td>21</td><td>24</td><td>63</td></tr> </table>	11	12	13	14	15	21	24	63
11	12	13	14								
15	21	24	63								
FPS484VS-3		VS	<table border="1"> <tr><td>11</td><td>12</td><td>13</td><td>14</td></tr> <tr><td>15</td><td>21</td><td>24</td><td>63</td></tr> </table>	11	12	13	14	15	21	24	63
11	12	13	14								
15	21	24	63								
FPS584VS-3		EL VS	<table border="1"> <tr><td>11</td><td>12</td><td>13</td><td>14</td></tr> <tr><td>15</td><td>21</td><td>24</td><td>63</td></tr> </table>	11	12	13	14	15	21	24	63
11	12	13	14								
15	21	24	63								
FPS684VS-3		EL VS	<table border="1"> <tr><td>11</td><td>12</td><td>13</td><td>14</td></tr> <tr><td>15</td><td>21</td><td>24</td><td>63</td></tr> </table>	11	12	13	14	15	21	24	63
11	12	13	14								
15	21	24	63								

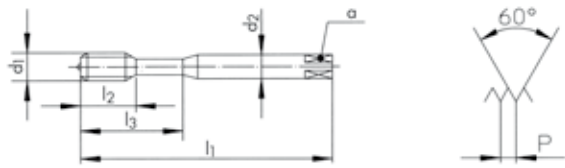

$\varnothing d_1$ M	P mm	l_1 mm	l_2 mm	l_3 mm	d_2 mm	α mm	6HX → ←	Tol.
3	0.50	56	12.0	18	3.5	2.7	2.80	+ 0.03
4	0.70	63	14.0	21	4.5	3.4	3.70	+ 0.03
5	0.80	70	15.0	25	6.0	4.9	4.65	+ 0.03
6	1.00	80	17.0	30	6.0	4.9	5.55	+ 0.05
8	1.25	90	20.0	35	8.0	6.2	7.40	+ 0.05
10	1.50	100	22.0	39	10.0	8.0	9.30	+ 0.05
12	1.75	110	24.0		9.0	7.0	11.20	+ 0.05
14	2.00	110	28.0		11.0	9.0	13.10	+ 0.05
16	2.00	110	30.0		12.0	9.0	15.10	+ 0.05

ID **ID**

166737	
166738	
166640	
166650	
166660	
166670	
	166675
	166680
	166685

$\varnothing d_1$ M	P mm	l_1 mm	l_2 mm	l_3 mm	d_2 mm	α mm	6HX → ←	Tol.
3	0.50	100	12.0	18	3.5	2.7	2.80	+ 0.03
4	0.70	125	14.0	21	4.5	3.4	3.70	+ 0.03
5	0.80	140	15.0	25	6.0	4.9	4.65	+ 0.03
6	1.00	160	17.0	30	6.0	4.9	5.55	+ 0.05
8	1.25	180	20.0	35	8.0	6.2	7.40	+ 0.05
10	1.50	200	22.0	39	10.0	8.0	9.30	+ 0.05
12	1.75	224	24.0		9.0	7.0	11.20	+ 0.05

ID **ID**

	172763
	172766
	172769
	172772
	172775
	172778
	172781

FAS FORMING

FAS380VS-3



VS

12	13	14	15
21	22	23	24
41	51	61	63

FAS381VS-3



VS

12	13	14	15
21	22	23	24
41	51	61	63

FAS481VS-3



VS

12	13	14	15
21	22	23	24
41	51	61	63

FAS380VS-3



FAS381VS-3



FAS481VS-3



6HX

6HX

6HX

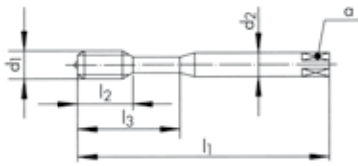

∅ d ₁ M	P mm	l ₁ mm	l ₂ mm	l ₃ mm	d ₂ mm	a mm	6HX Tol. → ←
3	0.50	56	12.0	18	3.5	2.7	2.80 +0.03
3.5	0.60	56	13.0	20	4.0	3.0	3.25 +0.03
4	0.70	63	14.0	21	4.5	3.4	3.70 +0.03
5	0.80	70	15.0	25	6.0	4.9	4.65 +0.03
6	1.00	80	17.0	30	6.0	4.9	5.55 +0.05
8	1.25	90	20.0	35	8.0	6.2	7.40 +0.05
10	1.50	100	22.0	39	10.0	8.0	9.30 +0.05
12	1.75	110	24.0		9.0	7.0	11.20 +0.05
14	2.00	110	28.0		11.0	9.0	13.10 +0.05
16	2.00	110	30.0		12.0	9.0	15.10 +0.05
20	2.50	140	36.0		16.0	12.0	18.85 +0.05

ID

ID

ID

170603

166612

170605

166618

170607

166624

170609

166632

170611

166641

170616

166651

170618

166661

166671

166676

166681

168711

6GX

6GX

∅ d ₁ M	P mm	l ₁ mm	l ₂ mm	l ₃ mm	d ₂ mm	a mm	6HX Tol. → ←
3	0.50	56	12.0	18	3.5	2.7	2.80 +0.03
3.5	0.60	56	13.0	20	4.0	3.0	3.25 +0.03
4	0.70	63	14.0	21	4.5	3.4	3.70 +0.03
5	0.80	70	15.0	25	6.0	4.9	4.65 +0.03
6	1.00	80	17.0	30	6.0	4.9	5.55 +0.05
8	1.25	90	20.0	35	8.0	6.2	7.40 +0.05
10	1.50	100	22.0	39	10.0	8.0	9.30 +0.05
12	1.75	110	24.0		9.0	7.0	11.20 +0.05
14	2.00	110	28.0		11.0	9.0	13.10 +0.05
16	2.00	110	30.0		12.0	9.0	15.10 +0.05

ID

6H

ID

6H

166703 0.020

* 166704 0.021

166705 0.022

166706 0.024

166707 0.026

166708 0.028

166709 0.032

166710 0.034

166711 0.038

166712 0.038

FAS FORMING

FAS384VS-3



12	13	14	15
21	22	23	24
41	51	61	63

FAS484VS-3



12	13	14	15
21	22	23	24
41	51	61	63

FAS384VS-3

FAS484VS-3

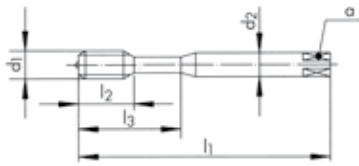

6HX

6HX

$\varnothing d_1$ M	P mm	l_1 mm	l_2 mm	l_3 mm	d_2 mm	a mm	6HX → ←	Tol.
3	0.50	56	12.0	18	3.5	2.7	2.80	+ 0.03
4	0.70	63	14.0	21	4.5	3.4	3.70	+ 0.03
5	0.80	70	15.0	25	6.0	4.9	4.65	+ 0.03
6	1.00	80	17.0	30	6.0	4.9	5.55	+ 0.05
8	1.25	90	20.0	35	8.0	6.2	7.40	+ 0.05
10	1.50	100	22.0	39	10.0	8.0	9.30	+ 0.05
12	1.75	110	24.0		9.0	7.0	11.20	+ 0.05
14	2.00	110	28.0		11.0	9.0	13.10	+ 0.05
16	2.00	110	30.0		12.0	9.0	15.10	+ 0.05

ID

ID

166741

166742

166690

166691

166692

166693

166694

* 166695

166696

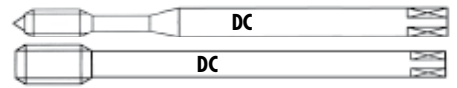

FAS FORMING

FAS581VS-3 **EL VS**

FAS681VS-3 **EL VS**

FAS584VS-3 **EL VS**

FAS684VS-3 **EL VS**



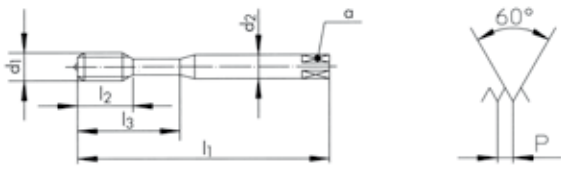







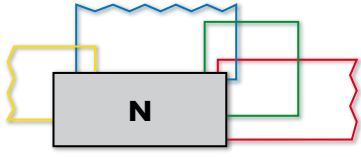
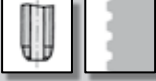
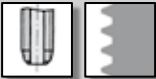

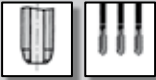
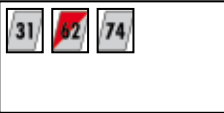



FAS581VS-3	FAS681VS-3	FAS584VS-3	FAS684VS-3
------------	------------	------------	------------



$\varnothing d_1$ M	P mm	l_1 mm	l_2 mm	l_3 mm	d_2 mm	α mm	6HX Tol. → ←
3	0.50	100	12.0	18	3.5	2.7	2.80 + 0.03
4	0.70	125	14.0	21	4.5	3.4	3.70 + 0.03
5	0.80	140	15.0	25	6.0	4.9	4.65 + 0.03
6	1.00	160	17.0	30	6.0	4.9	5.55 + 0.05
8	1.25	180	20.0	35	8.0	6.2	7.40 + 0.05
10	1.50	200	22.0	39	10.0	8.0	9.30 + 0.05
12	1.75	224	24.0		9.0	7.0	11.20 + 0.05

ID	ID	ID	ID
172784		172805	
172787		172808	
172790		172811	
172793		172814	
172796		172817	
172799		172820	
	172802		172822

									N1110-1	N1110-2	N1110-3	N1110-S
N1110-1												
N1110-2												
N1110-3												
N1110-S												
Ø d ₁ M	P mm	l ₁ mm	l ₂ mm	l ₃ mm	d ₂ mm	a mm			ID	ID	ID	ID
1	0.25	40	5.5		2.50	2.10	3	0.75	102744	102844	102917	111015
1.2	0.25	40	5.5		2.50	2.10	3	0.95	102746	102846	102919	111017
1.4	0.30	40	7.0		2.50	2.10	3	1.10	102747	102847	102920	111018
1.6	0.35	40	8.0		2.50	2.10	3	1.25	102749	102849	102922	111020
1.7	0.35	40	8.0		2.50	2.10	3	1.35	102750	102850	102923	111021
1.8	0.35	40	8.0		2.50	2.10	3	1.45	102751	102851	102924	111022
2	0.40	45	8.0		2.80	2.10	3	1.60	102759	102854	102934	111028
2.2	0.45	45	9.5		2.80	2.10	3	1.75	102761	102856	102937	111030
2.5	0.45	45	9.5		2.80	2.10	3	2.05	102763	102858	102941	111032
2.6	0.45	45	9.5		2.80	2.10	3	2.15	102765	102860	102944	111034
3	0.50	48	11.0	18	3.15	2.50	3	2.50	102766	102861	102947	111036
3.5	0.60	50	13.0	20	3.55	2.80	3	2.90	102769	102864	102950	111038
4	0.70	53	13.0	21	4.00	3.15	3	3.30	102771	102866	102956	111042
4.5	0.75	53	13.0	21	4.50	3.55	3	3.75	102775	102869	102959	111044
5	0.80	58	16.0	25	5.00	4.00	3	4.20	102776	102870	102965	111047
6	1.00	66	19.0	30	6.30	5.00	3	5.00	102781	102874	102973	111053
7	1.00	66	19.0	30	7.10	5.60	3	6.00	102786	102876	102978	111055
8	1.25	72	22.0	35	8.00	6.30	3	6.80	102788	102878	102986	111059
9	1.25	72	22.0	36	9.00	7.10	3	7.80	102792	102880	102991	111061
10	1.50	80	24.0	39	10.00	8.00	3	8.50	102752	102852	102931	111026

									N1210-1	N1210-2	N1210-3	N1210-S
									    <div style="border: 1px solid black; padding: 5px; display: inline-block; margin-top: 10px;">  </div>			
   									  			
  									 			
$\varnothing d_1$ M	P mm	l_1 mm	l_2 mm	d_2 mm	α mm			ID	ID	ID	ID	
11	1.50	85	22.0	8.0	6.3	3	9.50	103302	103427	103489	111168	
12	1.75	89	24.0	9.0	7.1	3	10.20	103303	103428	103499	111173	
14	2.00	95	24.0	11.2	9.0	3	12.00	103310	103430	103510	111179	
16	2.00	102	32.0	12.5	10.0	3	14.00	103319	103432	103522	111185	
18	2.50	112	30.0	14.0	11.2	3	15.50	103324	103434	103534	111191	
20	2.50	112	37.0	14.0	11.2	3	17.50	103330	103436	103543	111196	
22	2.50	115	32.0	16.0	12.5	3	19.50	103337	103438	103550	125567	
24	3.00	130	45.0	18.0	14.0	4	21.00	103341	103440	103557	111204	
27	3.00	135	45.0	20.0	16.0	4	24.00	103347	103442	103568	111211	
30	3.50	138	48.0	20.0	16.0	4	26.50	103353	103444	103579	111216	
33	3.50	151	51.0	22.4	18.0	4	29.50	103357	103446	103581	111218	
36	4.00	162	57.0	25.0	20.0	4	32.00	103359	103448	103583	111220	

										N1120-4	N1220-4	N1160-3	N1260-3
N1120-4													
N1220-4												NEW	NEW
N1160-3													
N1260-3													
$\varnothing d_1$	P	l_1	l_2	l_3	d_2	a				ID	ID		
M	mm	mm	mm	mm	mm	mm							
3	0.50	48	11.0	18	3.15	2.50	3	2.50		103068			
4	0.70	53	13.0	21	4.00	3.15	3	3.30		103075			
4.5	0.75	53	13.0	21	4.50	3.55	3	3.75		* 103078			
5	0.80	58	16.0	25	5.00	4.00	3	4.20		103082			
6	1.00	66	19.0	30	6.30	5.00	3	5.00		103090			
8	1.25	72	22.0	35	8.00	6.30	3	6.80		103102			
10	1.50	80	24.0	39	10.00	8.00	3	8.50		103060			
11	1.50	85	22.0		8.00	6.30	3	9.50			* 103661		
12	1.75	89	24.0		9.00	7.10	3	10.20			103670		
14	2.00	95	24.0		11.20	9.00	3	12.00			103680		
16	2.00	102	32.0		12.50	10.00	3	14.00			103690		
$\varnothing d_1$	P	l_1	l_2	l_3	d_2	a				ID	ID		
M	mm	mm	mm	mm	mm	mm							
3	0.50	48	5.5	18	3.15	2.50	3	2.50			103177		
4	0.70	53	7.5	21	4.00	3.15	3	3.30			103178		
5	0.80	58	9.0	25	5.00	4.00	3	4.20			103179		
6	1.00	66	11.0	30	6.30	5.00	3	5.00			103180		
8	1.25	72	12.5	35	8.00	6.30	3	6.80			103181		
10	1.50	80	14.0	39	10.00	8.00	3	8.50			103174		
12	1.75	89	14.0		9.00	7.10	3	10.20				103781	
16	2.00	102	18.0		12.50	10.00	3	14.00				103782	

















































285



	N							
Характеристики Cechy charakterystyczne								
Типы отверстий Typ otworu								
		N320-3	N320-4			N350-3	N360-3	
Длинный по DIN DIN długi	DIN 371	84	84			84	91	
Короткий по ISO ISO krótki	ISO 529							
Длинный по DIN DIN długi	~DIN 2174							
Класс точности Tolerancja	ISO 2 6H		84			84	91	
Повышенный класс точности Tolerancja dokładna	ISO 1 4H	84						
Класс точности Nadwymiar	ISO 3 6G						91	
	N410-3	N420-3	N420-4	N420V-4	N420TN-4	N450-3	N460-3	
Длинный по DIN DIN długi	DIN 374	85/90	88/89	85/90	85/88	85/86	84	92/93
Короткий по ISO ISO krótki	ISO 529							
Длинный по DIN DIN długi	~DIN 2174							
Класс точности Tolerancja	ISO 2 6H	85/90		85/90	85/88	85/86	84	92/93
Повышенный класс точности Tolerancja dokładna	ISO 1 4H							
Класс точности Nadwymiar	ISO 3 6G							92
Класс точности Tolerancja	7H (EN 60423)		88/89					
Левая резьба LH Gwint lewy	ISO 2 6H	90		90				

N					Z			
N360V-3	N360TN-3	N1110-1	N1110-3	N1110-S	Z320V-3 Z320V-4	Z320VS-4	Z360V-3	Z370VS-3
91	91	106	106	106	94	94	94	94
91	91		106	106	94	94	94	94
					94			
N460V-3	N460TN-3	N1210-1	N1210-3	N1210-S	Z420V-4	Z420VS-4	Z460V-3	Z470VS-3
92/93	92	107/108	107/108	107/108	95	95	95	95
92/93	92		107/108	107/108	95	95	95	95

	H		S		SA		
Характеристики Cechy charakterystyczne							
			VS	VS			
							
Типы отверстий Typ otworu							
	H320-4	H350-3	S320VS-4	S360VS-3	SA320-4	SA350-3	SA390-3
Длинный по DIN DIN długi	DIN 371						
Короткий по ISO ISO krótki	ISO 529						
Длинный по DIN DIN długi	~DIN 2174						
Класс точности Tolerancja	ISO 2 6H	96	97	98	98	100	100
Повышенный класс точности Tolerancja dokładna	ISO 1 4H				100	100	
Класс точности Nadwymiar	ISO 3 6G						
	H420-4	H450-3	S420VS-4	S460VS-3	SA420-4	SA450-3	
Длинный по DIN DIN długi	DIN 374						
Короткий по ISO ISO krótki	ISO 529						
Длинный по DIN DIN długi	~DIN 2174						
Класс точности Tolerancja	ISO 2 6H	96	97	98	98	101	101
Повышенный класс точности Tolerancja dokładna	ISO 1 4H				101	101	

TL		K	RTS		FPS		FAS	
		 TiCN						
VS	VS		VS	VS	CrN	VS	VS	
		 NEW						
								
TL320VS-4	TL351VS-3	K313TC-3	RTS320VS-4	RTS362VS-3	FPS381CN-3	FPS381VS-3	FAS381VS-3	
100	100	103	102	102				
					104	104	105	
100	100	103	102	102	104	104	105	
100	100							
TL420VS-4	TL451VS-3	K413TC-3	RTS420VS-4	RTS462VS-3	FPS481CN-3	FPS481VS-3	FAS481VS-3	
101	101	103	102	102				
						104	105	
101	101	103	102	102		104	105	
101	101							

MF ISO DIN 13

≤ Ø 2.8 > Ø 2.8

PM

HSSE



DIN 371

HSSE

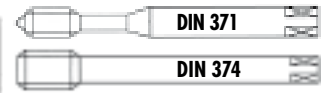

DIN 371

DIN 374

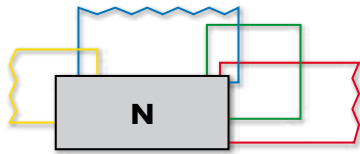

N320-4

N350-3

N450-3

N320-4



N350-3



N450-3

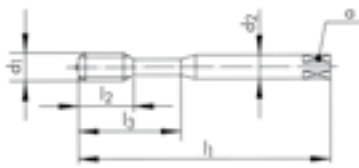

**ISO 2
6H**

**ISO 2
6H**

**ISO 2
6H**

∅ d ₁ MF	P mm	l ₁ mm	l ₂ mm	l ₃ mm	d ₂ mm	α mm		
*2	0.25	45	8.0		2.8	2.1	2	1.75
2.5	0.35	50	10.0		2.8	2.1	3	2.15
2.6	0.35	50	10.0		2.8	2.1	3	2.25
3	0.35	56	12.0	18	3.5	2.7	3	2.65
3.5	0.35	56	13.0	20	4.0	3.0	3	3.15

ID

142689
142691
142692
142693
142694

∅ d ₁ MF	P mm	l ₁ mm	l ₂ mm	l ₃ mm	d ₂ mm	α mm		
4	0.50	63	14.0	21	4.5	3.4	2	3.50
5	0.50	70	15.0	25	6.0	4.9	3	4.50
6	0.75	80	17.0	30	6.0	4.9	3	5.25
8	1.00	90	20.0		6.0	4.9	3	7.00
9	0.75	90	20.0		7.0	5.5	3	8.25
10	1.00	100	22.0		7.0	5.5	3	9.00
12	1.00	100	24.0		9.0	7.0	3	11.00
12	1.50	100	24.0		9.0	7.0	3	10.50
14	1.50	100	24.0		11.0	9.0	3	12.50
16	1.50	100	26.0		12.0	9.0	3	14.50
18	1.50	110	26.0		14.0	11.0	4	16.50
20	1.50	125	28.0		16.0	12.0	4	18.50

ID

ID

101586
101588
101590

102326
102328
102313
* 102315
* 102316
* 102318
* 102320
* 102322
* 102323

* N320-3



P 0.25



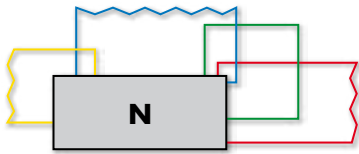



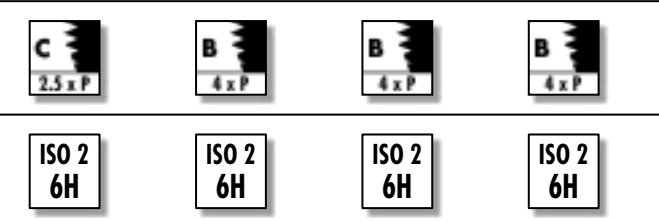
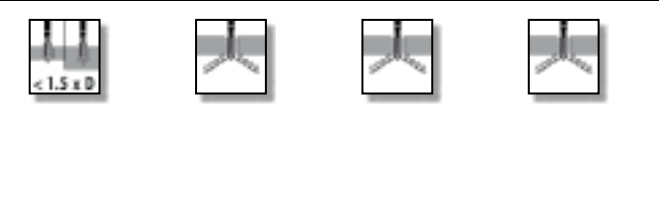



N410-3	N420-4	N420V-4	N420TN-4
--------	--------	---------	----------





ID	ID	ID	ID
	142695		
101923	102145	142715	
	102150		
101941	102167	142716	
	102168		
	142696		
101951	102178	142717	
101952	102179	102281	102249
	102187		
101954	102188		
101955	102190	142718	
101956	102191	102283	
101957	102192	102284	102250
	142697		
	102200		
	102201	143935	
	142698		
101863	102056		
101864	102057	102262	102239
101865	102058	142719	



N410-3  

N420-4  



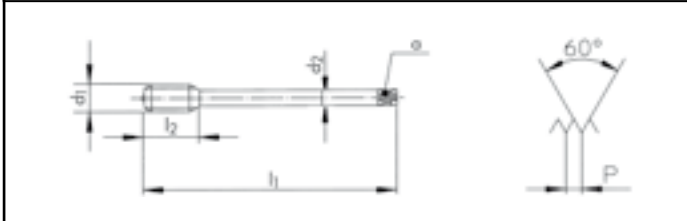



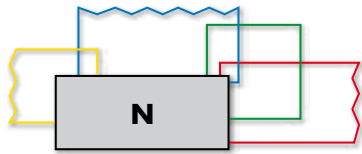

N420V-4   

N420TN-4   







MF	∅ d ₁ mm	P mm	l ₁ mm	l ₂ mm	d ₂ mm	a mm		
4	0.35	63	14.0	2.8	2.1	3	3.65	
4	0.50	63	14.0	2.8	2.1	3	3.50	
4.5	0.50	70	15.0	3.5	2.7	3	4.00	
5	0.50	70	15.0	3.5	2.7	3	4.50	
5	0.75	70	15.0	3.5	2.7	3	4.25	
5.5	0.50	80	17.0	4.0	3.0	3	5.00	
6	0.50	80	17.0	4.5	3.4	3	5.50	
6	0.75	80	17.0	4.5	3.4	3	5.25	
7	0.50	80	17.0	5.5	4.3	3	6.50	
7	0.75	80	17.0	5.5	4.3	3	6.25	
8	0.50	90	20.0	6.0	4.9	3	7.50	
8	0.75	90	20.0	6.0	4.9	3	7.25	
8	1.00	90	20.0	6.0	4.9	3	7.00	
9	0.50	90	20.0	7.0	5.5	3	8.50	
9	0.75	90	20.0	7.0	5.5	3	8.25	
9	1.00	90	20.0	7.0	5.5	3	8.00	
10	0.50	100	22.0	7.0	5.5	3	9.50	
10	0.75	100	22.0	7.0	5.5	3	9.25	
10	1.00	100	22.0	7.0	5.5	3	9.00	
10	1.25	100	22.0	7.0	5.5	3	8.80	







N410-3		
N420-4		
N420V-4	 V	
N420TN-4	 TiN	

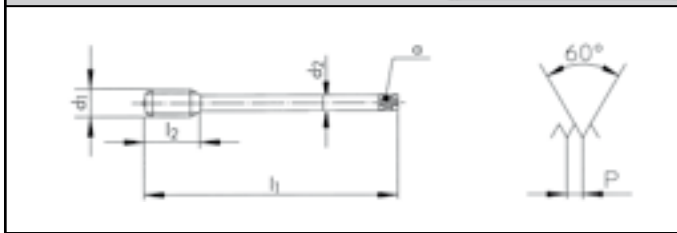

N410-3	N420-4	N420V-4	N420TN-4
--------	--------	---------	----------



			
< 1.5 x D			







			
ISO 2 6H	ISO 2 6H	ISO 2 6H	ISO 2 6H

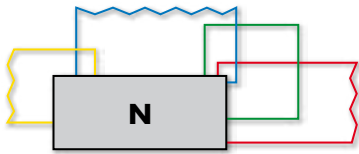

∅ d ₁ MF	P mm	l ₁ mm	l ₂ mm	d ₂ mm	a mm			ID	ID	ID	ID
11	0.50	100	19.0	8.0	6.2	3	10.50		142699		
11	0.75	100	19.0	8.0	6.2	3	10.25		142700		
11	1.00	100	19.0	8.0	6.2	3	10.00		142701		
11	1.25	100	19.0	8.0	6.2	3	9.80		142702		
12	0.50	100	14.0	9.0	7.0	3	11.50		102066		
12	0.75	100	24.0	9.0	7.0	3	11.25		142703		
12	1.00	100	24.0	9.0	7.0	3	11.00	101867	102067	142345	102241
12	1.25	100	24.0	9.0	7.0	3	10.80	101868	102068	142721	
12	1.50	100	24.0	9.0	7.0	3	10.50	101869	102069	102264	102242
13	1.00	100	21.0	11.0	9.0	3	12.00	158401	142704		
14	0.50	100	14.0	11.0	9.0	3	13.50		142705		
14	0.75	100	24.0	11.0	9.0	3	13.25		142706		
14	1.00	100	24.0	11.0	9.0	3	13.00	101871	102077		
14	1.25	100	24.0	11.0	9.0	3	12.80	101872	102078		
14	1.50	100	24.0	11.0	9.0	3	12.50	101873	102079	102266	102244
15	1.00	100	26.0	12.0	9.0	3	14.00	101875	102085		
15	1.50	100	26.0	12.0	9.0	3	13.50	101876	102086		
16	0.75	100	26.0	12.0	9.0	3	15.25		142708		
16	1.00	100	26.0	12.0	9.0	*3	15.00	101877	102087		
16	1.25	100	26.0	12.0	9.0	*3	14.80	101878	102088		
16	1.50	100	26.0	12.0	9.0	*3	14.50	101879	102089	102268	102246
17	1.00	100	26.0	12.0	9.0	3	16.00		142709		
17	1.50	100	26.0	12.0	9.0	3	15.50		142710		
18	0.75	110	26.0	14.0	11.0	4	17.25		142711		
18	1.00	110	26.0	14.0	11.0	4	17.00	101881	102095		
18	1.50	110	26.0	14.0	11.0	4	16.50	101882	102096	102270	
18	2.00	125	33.0	14.0	11.0	3	16.00		142712		
19	1.00	110	26.0	14.0	11.0	4	18.00		* 142713		

* N410-3 =  4









N410-3  

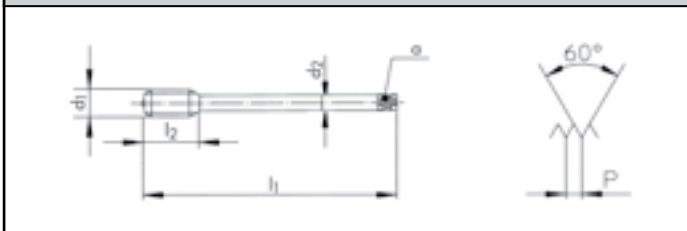
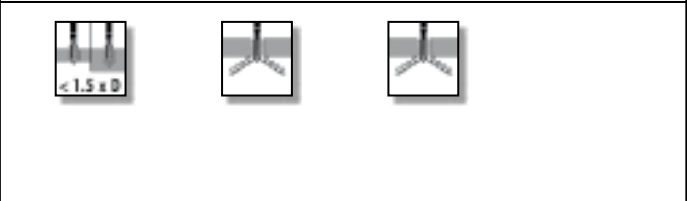

N420-4  

N420V-4   







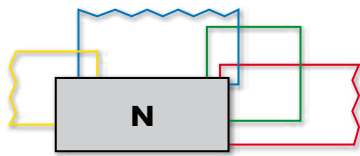

N410-3	N420-4	N420V-4	
--------	--------	---------	--











		
		





$\varnothing d_1$ MF	P mm	l_1 mm	l_2 mm	d_2 mm	a mm			ID	ID	ID
20	1.00	125	28.0	16.0	12.0	4	19.00		102098	
20	1.50	125	28.0	16.0	12.0	4	18.50	101884	102099	102272
20	2.00	140	36.0	16.0	12.0	3	18.00	105130	102100	
22	1.00	125	28.0	18.0	14.5	4	21.00		102104	
22	1.50	125	28.0	18.0	14.5	4	20.50	101886	102105	102274
22	2.00	140	36.0	18.0	14.5	3	20.00	101887	142714	
24	1.00	140	30.0	18.0	14.5	4	23.00		102107	
24	1.50	140	30.0	18.0	14.5	4	22.50	101889	102108	102276
24	2.00	140	34.0	18.0	14.5	4	22.00	101890	102109	102277
25	1.00	140	30.0	18.0	14.5	4	24.00		142722	
25	1.50	140	30.0	18.0	14.5	4	23.50	101892	102112	
25	2.00	140	34.0	18.0	14.5	4	23.00		142723	
26	1.00	140	30.0	18.0	14.5	4	25.00		102113	
26	1.50	140	30.0	18.0	14.5	4	24.50	101893	102114	145896
27	1.50	140	34.0	20.0	16.0	4	25.50		102115	
27	2.00	140	34.0	20.0	16.0	4	25.00	101894	102116	
28	1.00	140	30.0	20.0	16.0	4	27.00		142725	
28	1.50	140	30.0	20.0	16.0	4	26.50	101896	102118	
28	2.00	140	30.0	20.0	16.0	4	26.00	122023		



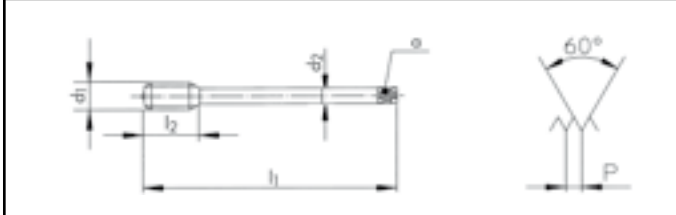

N410-3		
N420-4		
N420V-4	 V	
N420-3		

N410-3	N420-4	N420V-4	N420-3
			
			



			
ISO 2 6H	ISO 2 6H	ISO 2 6H	ISO 3 7H

∅ d ₁ MF	P mm	l ₁ mm	l ₂ mm	d ₂ mm	α mm			ID	ID	ID	ID
30	1.00	150	32.0	22.0	18.0	4	29.00	101898	102121		
30	1.50	150	32.0	22.0	18.0	4	28.50	101899	102122	143978	
30	2.00	150	32.0	22.0	18.0	4	28.00	101900	102123	143766	
32	1.00	150	32.0	22.0	18.0	4	31.00	101902			
32	1.50	150	32.0	22.0	18.0	4	30.50	101903	102126		143812
32	2.00	150	32.0	22.0	18.0	4	30.00	101904	102127		
33	1.50	160	32.0	25.0	20.0	4	31.50	101905	102128		
33	2.00	160	32.0	25.0	20.0	4	31.00	101906	102129		
34	1.00	170	32.0	28.0	22.0	4	33.00	* 101908			
34	1.50	170	32.0	28.0	22.0	4	32.50	101909	* 102131		
35	1.50	170	32.0	28.0	22.0	4	33.50	101910	102132		
35	2.00	170	32.0	28.0	22.0	4	33.00	101911			
36	1.00	170	34.0	28.0	22.0	4	35.00		* 102133		
36	1.50	170	34.0	28.0	22.0	4	34.50	101912	102134		
36	2.00	170	34.0	28.0	22.0	4	34.00	101913	102135		
36	3.00	200	45.0	28.0	22.0	4	33.00	101914	102136		
38	1.00	170	34.0	28.0	22.0	4	37.00	* 101916	* 102138		
38	1.50	170	34.0	28.0	22.0	4	36.50	101917	102139		
38	2.00	170	34.0	28.0	22.0	4	36.00	101918			
39	2.00	170	34.0	32.0	24.0	4	37.00	101920			
39	3.00	200	45.0	32.0	24.0	4	36.00	101921			

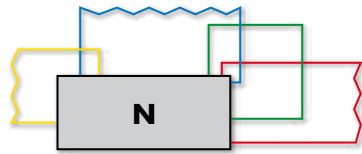

N410-3

N420-4

N420-3

N410-3





N420-4

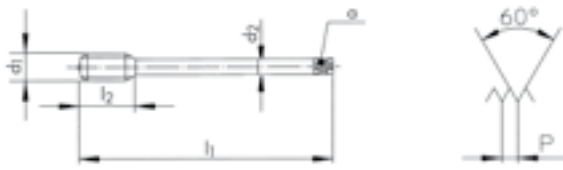

N420-3



MF	∅ d ₁ mm	P mm	l ₁ mm	l ₂ mm	d ₂ mm	α mm		 6H
40	1.00	170	34.0	32.0	24.0	5	39.00	
40	1.50	170	34.0	32.0	24.0	5	38.50	
40	2.00	170	34.0	32.0	24.0	5	38.00	
40	3.00	200	45.0	32.0	24.0	4	37.00	
42	1.50	170	34.0	32.0	24.0	5	40.50	
42	2.00	170	34.0	32.0	24.0	5	40.00	
42	3.00	200	45.0	32.0	24.0	4	39.00	
45	1.50	180	34.0	36.0	29.0	5	43.50	
45	2.00	180	34.0	36.0	29.0	5	43.00	
45	3.00	200	45.0	36.0	29.0	4	42.00	
48	1.50	190	36.0	36.0	29.0	5	46.50	
48	2.00	190	36.0	36.0	29.0	5	46.00	
48	3.00	220	48.0	36.0	29.0	5	45.00	
50	1.50	190	36.0	36.0	29.0	5	48.50	
50	2.00	190	36.0	36.0	29.0	5	48.00	
52	1.50	190	36.0	40.0	32.0	5	50.50	
52	2.00	190	36.0	40.0	32.0	5	50.00	
52	3.00	220	48.0	40.0	32.0	5	49.00	
55	2.00	190	40.0	40.0	32.0	5	53.00	
60	2.00	220	42.0	45.0	35.0	5	58.00	
63	1.50	220	38.0	45.0	35.0	5	61.50	

ID

ID

ID

101925

101926

102152

143813

101927

102153

* 101928

* 102154

101929

102155

101930

102156

101931

102157

101933

102159

101934

101935

* 102161

101937

102163

101938

102164

101939

102165

101943

102176

143814

* 101944

* 102177

* 101946

101947

* 101948

* 105131

105132

143815

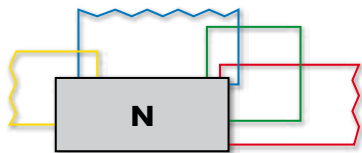

N410-3 LH





N420-4 LH

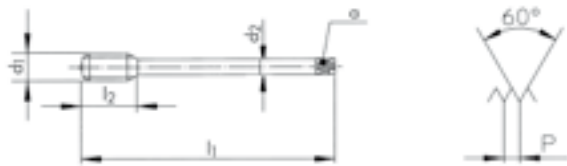

N410-3 LH

N420-4 LH



$\varnothing d_1$ MF	P mm	l_1 mm	l_2 mm	d_2 mm	a mm			ID	ID
4	0.50	63	14.0	2.8	2.1	3	3.50	104844	
5	0.50	70	15.0	3.5	2.7	3	4.50	104845	
6	0.50	80	17.0	4.5	3.4	3	5.50	104846	104870
6	0.75	80	17.0	4.5	3.4	3	5.25	104847	105133
7	0.75	80	17.0	5.5	4.3	3	6.25	104848	
8	0.50	90	20.0	6.0	4.9	3	7.50	104849	
8	0.75	90	20.0	6.0	4.9	3	7.25	104850	104871
8	1.00	90	20.0	6.0	4.9	3	7.00	104851	104872
10	0.75	100	22.0	7.0	5.5	3	9.25	104852	
10	1.00	100	22.0	7.0	5.5	3	9.00	104853	104873
10	1.25	100	22.0	7.0	5.5	3	8.80		104874
12	1.00	100	24.0	9.0	7.0	3	11.00	104854	104875
12	1.25	100	24.0	9.0	7.0	3	10.80	104855	104876
12	1.50	100	24.0	9.0	7.0	3	10.50	104856	104877
14	1.00	100	24.0	11.0	9.0	3	13.00	104857	104878
14	1.25	100	24.0	11.0	9.0	3	12.80	104858	
14	1.50	100	24.0	11.0	9.0	3	12.50	104859	104879
16	1.00	100	26.0	12.0	9.0	*3	15.00	104860	104880
16	1.50	100	26.0	12.0	9.0	*3	14.50	104861	104881
18	1.00	110	26.0	14.0	11.0	4	17.00	104862	
18	1.50	110	26.0	14.0	11.0	4	16.50	104863	104882
20	1.00	125	28.0	16.0	12.0	4	19.00	104864	
20	1.50	125	28.0	16.0	12.0	4	18.50	104865	104883
22	1.50	125	28.0	18.0	14.5	4	20.50	104866	104884
24	1.50	140	30.0	18.0	14.5	4	22.50	104867	104885
24	2.00	140	34.0	18.0	14.5	4	22.00	104868	104886
28	1.50	140	30.0	20.0	16.0	4	26.50	105166	
30	1.50	150	32.0	22.0	18.0	4	28.50	105167	105165
30	2.00	150	32.0	22.0	18.0	4	28.00	105168	

* N410-3 LH =  4

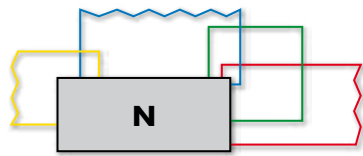

N360-3

N360V-3

N360TN-3

N360-3



N360-3



N360V-3



N360TN-3

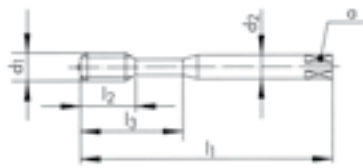

ISO 2
6H

ISO 2
6H

ISO 2
6H

ISO 3
6G

MF	∅ d ₁ mm	P mm	l ₁ mm	l ₂ mm	l ₃ mm	d ₂ mm	a mm	Flute	6H mm
4	0.50	63	7.5	21	4.5	3.4	3	3.50	
5	0.50	70	9.0	25	6.0	4.9	3	4.50	
6	0.50	80	11.0	30	6.0	4.9	3	5.50	
6	0.75	80	11.0	30	6.0	4.9	3	5.25	
8	0.75	90	12.5	35	8.0	6.2	3	7.25	
8	1.00	90	12.5	35	8.0	6.2	3	7.00	
10	0.75	100	14.0	39	10.0	8.0	3	9.25	
10	1.00	100	14.0	39	10.0	8.0	3	9.00	
10	1.25	100	14.0	39	10.0	8.0	3	8.80	

ID	ID	ID	ID	6H + mm
101632	101712	111618	101631	0.020
101641	101714	111617	101640	0.020
101648	143990			
101650	101716	101702	101649	0.022
101658	101719		101657	0.022
101660	101720	101704	101659	0.026
101606	144401			
101608	101706	101695	101607	0.026
101609	105134	110965		

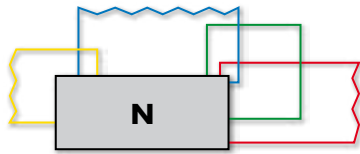

N460-3



N460V-3



N460TN-3



N460-3

N460V-3

N460TN-3

N460-3

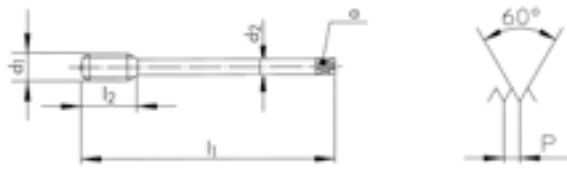



ISO 2
6H

ISO 2
6H

ISO 2
6H

ISO 3
6G

$\varnothing d_1$ MF	P mm	l_1 mm	l_2 mm	d_2 mm	a mm		$\pm 6H$ 	ID	ID	ID	ID ^{6H} + mm
12	1.00	100	14.0	9.0	7.0	3	11.00	102353	102462	102447	102352 0.026
12	1.25	100	14.0	9.0	7.0	3	10.80	102354	102463	144202	
12	1.50	100	14.0	9.0	7.0	3	10.50	102356	102464	102448	102355 0.032
13	1.00	100	14.0	11.0	9.0	3	12.00	102364			
14	1.00	100	14.0	11.0	9.0	3	13.00	102365	102466		
14	1.50	100	14.0	11.0	9.0	3	12.50	102367	102467	102450	102366 0.032
15	1.00	100	14.0	12.0	9.0	3	14.00	102370			
15	1.50	100	18.0	12.0	9.0	3	13.50	102371			
16	1.00	100	14.0	12.0	9.0	4	15.00	102372	102469		
16	1.50	100	14.0	12.0	9.0	4	14.50	102374	102470	102452	102373 0.032
18	1.00	110	18.0	14.0	11.0	4	17.00	102380	143926		
18	1.50	110	18.0	14.0	11.0	4	16.50	102382	102472		102381 0.032
20	1.00	125	20.0	16.0	12.0	4	19.00	102384	146377		
20	1.50	125	20.0	16.0	12.0	4	18.50	102386	102474		
20	2.00	140	24.0	16.0	12.0	4	18.00	102387	143566		
22	1.00	125	20.0	18.0	14.5	4	21.00	102392	147702		
22	1.50	125	20.0	18.0	14.5	4	20.50	102393	102476		
24	1.50	140	22.0	18.0	14.5	4	22.50	102396	102478		
24	2.00	140	22.0	18.0	14.5	4	22.00	102397	102479		
25	1.50	140	22.0	18.0	14.5	4	23.50	102399	143810		
26	1.50	140	22.0	18.0	14.5	4	24.50	102400	143952		
27	1.50	140	22.0	20.0	16.0	4	25.50	102401	143965		
27	2.00	140	22.0	20.0	16.0	4	25.00	102402	144201		
28	1.50	140	22.0	20.0	16.0	4	26.50	102403	144997		

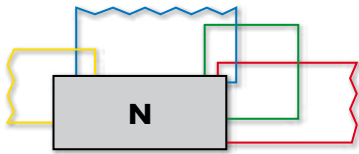

N460-3

N460V-3

N460-3



N460V-3

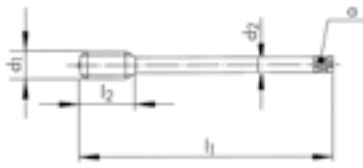

ISO 2
6H

ISO 2
6H

MF	$\varnothing d_1$ mm	P mm	l_1 mm	l_2 mm	d_2 mm	α mm		$\pm 6H$ mm
30	1.50	150	24.0	22.0	18.0	4	28.50	
30	2.00	150	24.0	22.0	18.0	4	28.00	
32	1.50	150	24.0	22.0	18.0	4	30.50	
33	2.00	160	26.0	25.0	20.0	4	31.00	
33	3.00	180	33.0	25.0	20.0	4	30.00	
35	1.50	170	24.0	28.0	22.0	5	33.50	
36	1.50	170	24.0	28.0	22.0	5	34.50	
36	2.00	170	28.0	28.0	22.0	5	34.00	
36	3.00	200	36.0	28.0	22.0	4	33.00	
39	3.00	200	40.0	32.0	24.0	5	36.00	
42	3.00	200	40.0	32.0	24.0	5	39.00	

ID

ID

102404	142524
102405	142581
102406	143605
102407	147604
175437	150448
102408	146846
102409	143824
175436	164870
115072	150453
174995	122669
174996	150436

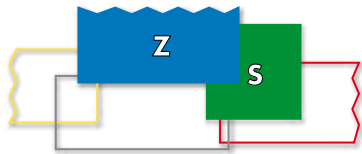

Z320V-4

Z320VS-4

Z360V-3

Z370VS-3



NEW



PM



ISO 2
6H

ISO 2
6H

ISO 2
6H

6HX

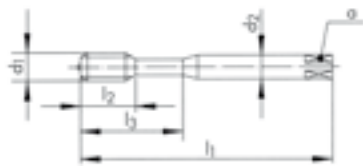

Z320V-4



Z320VS-4



Z360V-3



Z370VS-3



∅ d ₁ MF	P mm	l ₁ mm	l ₂ mm	l ₃ mm	d ₂ mm	a mm		
*2	0.20	45	8.0		2.8	2.1	2	1.80
*2	0.25	45	8.0		2.8	2.1	2	1.75
*2.2	0.25	45	9.0		2.8	2.1	2	1.95
2.5	0.20	50	10.0		2.8	2.1	3	2.30
2.5	0.25	50	10.0		2.8	2.1	3	2.25
3	0.35	56	12.0	18	3.5	2.7	3	2.65
6	0.75	80	17.0	30	6.0	4.9	3	5.25
8	1.00	90	20.0	35	8.0	6.2	3	7.00
10	1.00	100	22.0	39	10.0	8.0	3	9.00

B 4 x P	B 4 x P	C 2.5 x P	C 2.5 x P
ISO 2 6H	ISO 2 6H	ISO 2 6H	6HX
ID	ID		
146487			
114715			
115462			
115578			
115887			
115468			
142726			
142727	124289		
142728	120060		

∅ d ₁ MF	P mm	l ₁ mm	l ₂ mm	l ₃ mm	d ₂ mm	a mm		
4	0.50	63	7.5	21	4.5	3.4	3	3.50
5	0.50	70	9.0	25	6.0	4.9	3	4.50
6	0.75	80	11.0	30	6.0	4.9	3	5.25
8	1.00	90	12.5	35	8.0	6.2	3	7.00
10	1.00	100	14.0	39	10.0	8.0	3	9.00

ID
104675
104676
104677
104678
104674

∅ d ₁ MF	P mm	l ₁ mm	l ₂ mm	l ₃ mm	d ₂ h ₆ mm	a mm		
6	0.75	80	11.0	30	6.0	4.9	3	5.25
8	1.00	90	12.5	35	8.0	6.2	3	7.00
10	1.00	100	14.0	39	10.0	8.0	3	9.00

ID
166117
166118
166119

* Z320V-3



P ≤ 0.25



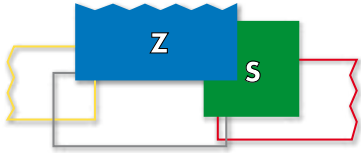

Z420V-4 Z420VS-4 Z460V-3 Z470VS-3



NEW



PM



ISO 2 6H ISO 2 6H ISO 2 6H 6HX

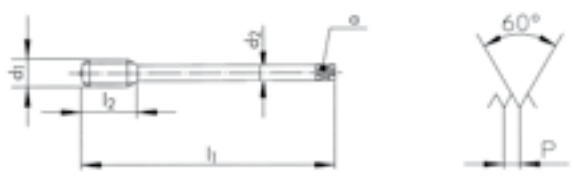

Z420V-4

Z420VS-4

Z460V-3

Z470VS-3

∅ d ₁ MF	P mm	l ₁ mm	l ₂ mm	d ₂ mm	a mm		
12	1.00	100	24.0	9.0	7.0	3	11.00
12	1.50	100	24.0	9.0	7.0	3	10.50
14	1.50	100	24.0	11.0	9.0	3	12.50
16	1.50	100	26.0	12.0	9.0	3	14.50

ID	ID
142729	
142730	120421
142731	120688
142732	120878











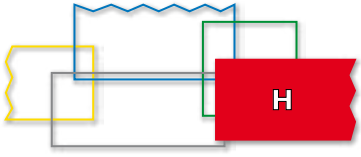

∅ d ₁ MF	P mm	l ₁ mm	l ₂ mm	d ₂ mm	a mm		
12	1.00	100	14.0	9.0	7.0	3	11.00
12	1.50	100	14.0	9.0	7.0	3	10.50
14	1.50	100	14.0	11.0	9.0	3	12.50
16	1.50	100	14.0	12.0	9.0	4	14.50
18	1.50	110	18.0	14.0	11.0	4	16.50
20	1.50	125	20.0	16.0	12.0	4	18.50
22	1.50	125	20.0	18.0	14.5	4	20.50
24	1.50	140	22.0	18.0	14.5	4	22.50
24	2.00	140	22.0	18.0	14.5	4	22.00

ID
104729
104730
104731
104732
104733
104734
104735
104736
104737

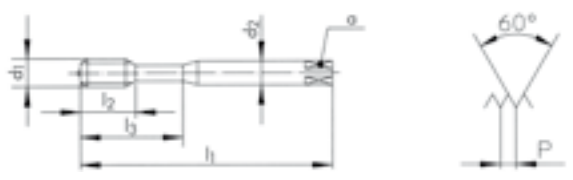
∅ d ₁ MF	P mm	l ₁ mm	l ₂ mm	d ₂ h ₆ mm	a mm		
12	1.50	110	14.0	*10.0	*8.0	4	10.50
14	1.50	110	14.0	*12.0	*9.0	4	12.50
16	1.50	110	18.0	12.0	9.0	4	14.50

ID
166120
166121
166122

* Norme DC / * DC Norm / * Norma DC

										H320-4	H420-4		
										H320-4			
H420-4													
													
													
$\varnothing d_1$ MF	P mm	l_1 mm	l_2 mm	l_3 mm	d_2 mm	a mm			ID	ID			
6	0.75	80	17.0	30	6.0	4.9	3	5.25	101214				
8	0.75	90	20.0	35	8.0	6.2	3	7.25	101216				
8	1.00	90	20.0	35	8.0	6.2	3	7.00	101217				
10	1.00	100	22.0	39	10.0	8.0	3	9.00	101204				
12	1.25	100	24.0		9.0	7.0	4	10.80		101273			
12	1.50	100	24.0		9.0	7.0	4	10.50		101274			
14	1.50	100	24.0		11.0	9.0	4	12.50		101276			
16	1.50	100	26.0		12.0	9.0	4	14.50		101278			
20	1.50	125	28.0		16.0	12.0	4	18.50		101282			
24	2.00	140	34.0		18.0	14.5	4	22.00		101285			

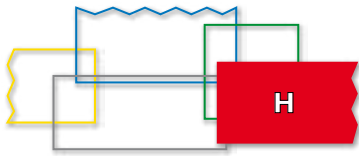

H350-3

H450-3

H350-3



H450-3

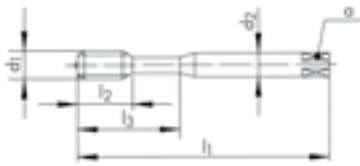

ISO 2
6H

ISO 2
6H

Ø d ₁ MF	P mm	l ₁ mm	l ₂ mm	l ₃ mm	d ₂ mm	α mm		
6	0.75	80	11.0	30	6.0	4.9	3	5.25
8	0.75	90	12.5	35	8.0	6.2	3	7.25
8	1.00	90	12.5	35	8.0	6.2	3	7.00
10	1.00	100	14.0	39	10.0	8.0	3	9.00
12	1.00	100	14.0		9.0	7.0	4	11.00
12	1.50	100	14.0		9.0	7.0	4	10.50
14	1.50	100	14.0		11.0	9.0	4	12.50
16	1.50	100	14.0		12.0	9.0	4	14.50
18	1.50	110	18.0		14.0	11.0	4	16.50
20	1.50	125	20.0		16.0	12.0	4	18.50
22	1.50	125	20.0		18.0	14.5	4	20.50
24	1.50	140	22.0		18.0	14.5	4	22.50
24	2.00	140	22.0		18.0	14.5	4	22.00
27	2.00	140	22.0		20.0	16.0	4	25.00
30	1.50	150	24.0		22.0	18.0	4	28.50
30	2.00	150	24.0		22.0	18.0	4	28.00

ID

ID

101249

101252

101253

101235

101302

101303

101306

101308

101310

101312

101314

101316

101317

101319

101321

101322

										S320VS-4	S420VS-4	S360VS-3	S460VS-3
S320VS-4													
S420VS-4													
S360VS-3													
S460VS-3													
$\varnothing d_1$	P	l_1	l_2	l_3	d_2	a				ID	ID		
MF	mm	mm	mm	mm	mm	mm							
6	0.75	80	17.0	30	6.0	4.9	3	5.25		* 123690			
8	1.00	90	20.0	35	8.0	6.2	3	7.00		124288			
10	1.00	100	22.0	39	10.0	8.0	3	9.00		120059			
12	1.50	100	24.0		9.0	7.0	4	10.50			120420		
14	1.50	100	24.0		11.0	9.0	4	12.50			120687		
16	1.50	100	26.0		12.0	9.0	4	14.50			120877		
$\varnothing d_1$	P	l_1	l_2	l_3	d_2	a				ID	ID		
MF	mm	mm	mm	mm	mm	mm							
8	1.00	90	12.5	35	8.0	6.2	3	7.00			111528		
10	1.00	100	14.0	39	10.0	8.0	3	9.00			111529		
12	1.50	100	14.0		9.0	7.0	4	10.50				111540	
14	1.50	100	14.0		11.0	9.0	4	12.50				111541	
16	1.50	100	14.0		12.0	9.0	4	14.50				111542	

aero

SA390-3

SA390-3

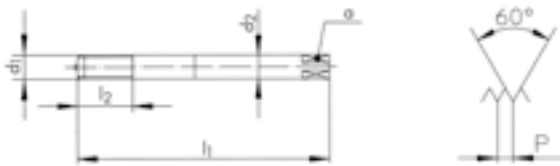

$\varnothing d_1$ MF	P mm	l_1 mm	l_2 mm	d_2 mm	α mm		
8	1.00	90	25.0	8.0	6.2	3	7.00
10	1.00	100	30.0	10.0	8.0	3	9.00
10	1.25	100	30.0	10.0	8.0	3	8.80
12	1.00	110	35.0	12.0	9.0	4	11.00
12	1.50	110	35.0	12.0	9.0	4	10.50
14	1.50	110	40.0	16.0	12.0	4	12.50

ID

* 149735

* 149751

* 149753

* 149769

* 149773













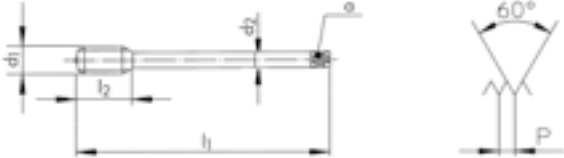

* 149790

MF

aero

										SA320-4	SA350-3	TL320VS-4	TL351VS-3
<p>SA320-4 </p> <p>SA350-3 </p>													
<p>TL320VS-4 VS </p> <p>TL351VS-3 VS </p>													
$\varnothing d_1$	P	l_1	l_2	l_3	d_2	a				ID	ID	ID	ID
MF	mm	mm	mm	mm	mm	mm							
4	0.50	63	14.0		4.5	3.4	3	3.50		* 149079	* 152032	152033	
5	0.50	70	15.0		6.0	4.9	3	4.50	* 149142	149144	* 152048	152049	
6	0.50	80	15.0	23	6.0	4.9	3	5.50	* 149193		* 152058	152059	
8	1.00	90	18.0	29	8.0	6.2	3	7.00	149304	149306	* 152079	152080	
10	1.00	100	20.0	33	10.0	8.0	3	9.00	149362	149364	* 152092	152093	
$\varnothing d_1$	P	l_1	l_2	l_3	d_2	a				ID	ID	ID	ID
MF	mm	mm	mm	mm	mm	mm							
4	0.50	63	14.0		4.5	3.4	3	3.50	149081	149083	* 152034	152035	
5	0.50	70	15.0		6.0	4.9	3	4.50	149146	149148	* 152050	152051	
6	0.50	80	15.0	23	6.0	4.9	3	5.50		* 149199	* 152060	152061	
8	1.00	90	18.0	29	8.0	6.2	3	7.00	149308	149310		148019	
10	1.00	100	20.0	33	10.0	8.0	3	9.00	149366	149368	* 152094	148026	

aero

									SA420-4	SA450-3	TL420VS-4	TL451VS-3
<p>SA420-4  52 53</p> <p>SA450-3  52 53</p>												
<p>TL420VS-4  VS 41 42</p> <p>TL451VS-3   VS 41 42</p>												
												
												
$\varnothing d_1$ MF	P mm	l_1 mm	l_2 mm	d_2 mm	a mm				ID	ID	ID	ID
12	1.00	100	19.0	9.0	7.0	4	11.00		* 152209		* 152218	
12	1.50	100	24.0	9.0	7.0	4	10.50		* 152208	* 152213		
14	1.50	100	24.0	11.0	9.0	4	12.50		* 152210	* 152214		* 152224
16	1.50	100	26.0	12.0	9.0	4	14.50		* 152212	* 152216		* 152226
												
$\varnothing d_1$ MF	P mm	l_1 mm	l_2 mm	d_2 mm	a mm				ID	ID	ID	ID
12	1.00	100	19.0	9.0	7.0	4	11.00		* 152228	* 148967	* 152237	* 152242
12	1.50	100	24.0	9.0	7.0	4	10.50		* 152227	* 152232		* 152241
14	1.50	100	24.0	11.0	9.0	4	12.50		* 152229	* 152233	* 152238	* 152243
16	1.00	100	23.0	12.0	9.0	4	15.00				* 152239	* 152244
16	1.50	100	26.0	12.0	9.0	4	14.50			* 152235	* 152240	* 152245

MF



Uniquement pour taraudage synchrone
Nur für Synchrobearbeitung
Only for rigid tapping
Solo per maschiatura sincrona
Solo para rosado sincronizado

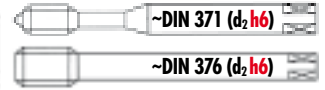

RTS Rigid Tapping Synchro

RTS320VS-4



11	12	13	14
15	21	22	31
32	61	63	72
73	74		

RTS420VS-4



RTS362VS-3



11	12	13	14
15	21	22	31
32	61	63	72
73	74		

RTS462VS-3



RTS320VS-4

RTS420VS-4

RTS362VS-3

RTS462VS-3



6HX

6HX

6HX

6HX

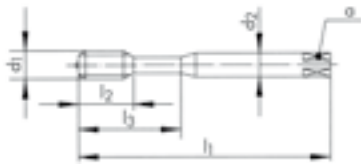

∅ d ₁ MF	P mm	l ₁ mm	l ₂ mm	l ₃ mm	d ₂ h6 mm	a mm		
8	1.00	90	12.5	35	8.0	6.2	3	7.00
10	1.00	100	14.0	39	10.0	8.0	3	9.00
12	1.50	110	14.0		*10.0	*8.0	3	10.50
14	1.50	110	14.0		*12.0	*9.0	3	12.50
16	1.50	110	18.0		12.0	9.0	3	14.50

* Norme DC / * DC Norm / * Norma DC

∅ d ₁ MF	P mm	l ₁ mm	l ₂ mm	l ₃ mm	d ₂ h6 mm	a mm		
8	1.00	90	12.5	35	8.0	6.2	3	7.00
10	1.00	100	14.0	39	10.0	8.0	3	9.00
12	1.50	110	14.0		*10.0	*8.0	3	10.50
14	1.50	110	14.0		*12.0	*9.0	3	12.50
16	1.50	110	18.0		12.0	9.0	3	14.50

* Norme DC / * DC Norm / * Norma DC



sur demande
auf Anfrage
on request
su richiesta
sobre pedido

K										K313TC-3	K413TC-3														
<div style="display: flex; justify-content: space-between;"> <div style="width: 45%;"> <p>K313TC-3</p> <p>>20 bar</p> </div> <div style="width: 45%;"> <table border="1"> <tr><td>11</td><td>12</td><td>13</td><td>14</td></tr> <tr><td>15</td><td>31</td><td>32</td><td>62</td></tr> <tr><td>63</td><td>74</td><td></td><td></td></tr> </table> </div> </div>										11	12	13	14	15	31	32	62	63	74						
11	12	13	14																						
15	31	32	62																						
63	74																								
<div style="display: flex; justify-content: space-between;"> <div style="width: 45%;"> <p>K413TC-3</p> <p>>20 bar</p> </div> <div style="width: 45%;"> <table border="1"> <tr><td>11</td><td>12</td><td>13</td><td>14</td></tr> <tr><td>15</td><td>31</td><td>32</td><td>62</td></tr> <tr><td>63</td><td>74</td><td></td><td></td></tr> </table> </div> </div>										11	12	13	14	15	31	32	62	63	74			NEW	NEW		
11	12	13	14																						
15	31	32	62																						
63	74																								
										6HX	6HX														
$\varnothing d_1$	P	l_1	l_2	l_3	l_6	d_2	a			ID	ID														
MF	mm	mm	mm	mm	mm	mm	mm																		
10	1.00	100	22.0	39	37	10.0	8.0	3	9.00	175729															
12	1.00	110	24.0		42	9.0	7.0	3	11.00		175731														
12	1.25	110	24.0		42	9.0	7.0	3	10.80		175733														
12	1.50	110	24.0		42	9.0	7.0	3	10.50		175735														
14	1.50	110	28.0		49	11.0	9.0	3	12.50		175737														
16	1.50	110	30.0		56	12.0	9.0	3	14.50		175739														
20	1.50	140	36.0		70	16.0	12.0	5	18.50		171205														

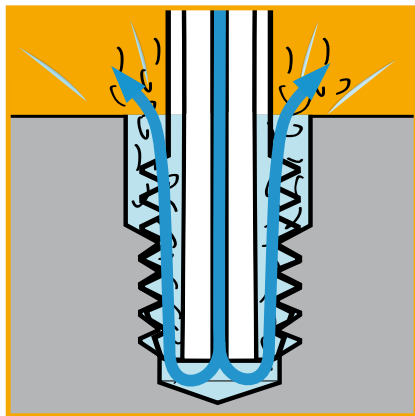

FPS FORMING

FPS381CN-3 63 71 72 73

FPS381VS-3 11 12 13 14 15
21 24 63

FPS481VS-3 11 12 13 14 15
21 24 63

FPS381CN-3 FPS381VS-3 FPS481VS-3

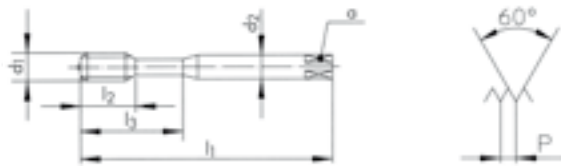
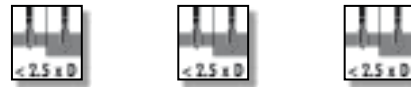

$\varnothing d_1$ MF	P mm	l_1 mm	l_2 mm	l_3 mm	d_2 mm	a mm	6HX → ←	Tol.
4	0.50	63	14.0	21	4.5	3.4	3.80	+ 0.03
5	0.50	70	15.0	25	6.0	4.9	4.80	+ 0.03
6	0.50	80	17.0	30	6.0	4.9	5.80	+ 0.03
6	0.75	80	17.0	30	6.0	4.9	5.65	+ 0.03
8	0.75	90	20.0	35	8.0	6.2	7.65	+ 0.03
8	1.00	90	20.0	35	8.0	6.2	7.55	+ 0.05
10	1.00	100	22.0	39	10.0	8.0	9.55	+ 0.05
12	1.00	100	19.0		9.0	7.0	11.55	+ 0.05
14	1.50	100	24.0		11.0	9.0	13.30	+ 0.05
16	1.50	100	26.0		12.0	9.0	15.30	+ 0.05

ID ID ID

166631
166639
166699
166648 166649
166701 166702
166658 166659
166668 166669
166674
166679
166684

FAS FORMING

FAS381VS-3



VS

12	13	14	15
21	22	23	24
41	51	61	63

FAS481VS-3



VS

12	13	14	15
21	22	23	24
41	51	61	63

FAS381VS-3

FAS481VS-3

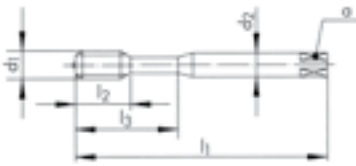

$\varnothing d_1$ MF	P mm	l_1 mm	l_2 mm	l_3 mm	d_2 mm	a mm	6HX → ←	Tol.
4	0.50	63	14.0	21	4.5	3.4	3.80	+ 0.03
5	0.50	70	15.0	25	6.0	4.9	4.80	+ 0.03
6	0.50	80	17.0	30	6.0	4.9	5.80	+ 0.03
6	0.75	80	17.0	30	6.0	4.9	5.65	+ 0.03
8	0.75	90	20.0	35	8.0	6.2	7.65	+ 0.03
8	1.00	90	20.0	35	8.0	6.2	7.55	+ 0.05
10	1.00	100	22.0	39	10.0	8.0	9.55	+ 0.05
12	1.00	100	19.0		9.0	7.0	11.55	+ 0.05
14	1.50	100	24.0		11.0	9.0	13.30	+ 0.05
16	1.50	100	26.0		12.0	9.0	15.30	+ 0.05

ID

ID

166625

166633

166698

166642

166700

166652

166662

166672

166677

166682

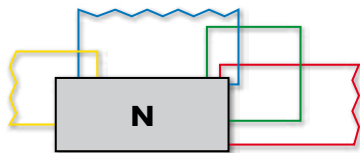
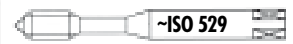

N1110-1

N1110-3

N1110-S

N1110-1

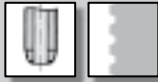

N1110-3

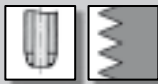

N1110-S

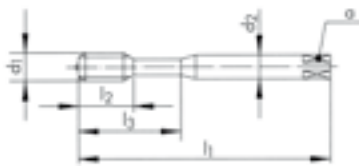

ISO 2
6H

ISO 2
6H

Ø d ₁ MF	P mm	l ₁ mm	l ₂ mm	l ₃ mm	d ₂ mm	a mm		
2	0.25	45	8.0		2.80	2.10	3	1.75
2.2	0.25	45	9.5		2.80	2.10	3	1.95
2.3	0.25	45	9.5		2.80	2.10	3	2.05
2.5	0.35	45	9.5		2.80	2.10	3	2.15
3	0.35	48	11.0	18	3.15	2.50	3	2.65
3.5	0.35	50	13.0	20	3.55	2.80	3	3.15
4	0.35	53	13.0	21	4.00	3.15	3	3.65
4	0.50	53	13.0	21	4.00	3.15	3	3.50
4.5	0.50	53	13.0	21	4.50	3.55	3	4.00
5	0.35	58	16.0	25	5.00	4.00	3	4.65
5	0.50	58	16.0	25	5.00	4.00	3	4.50
5	0.75	58	16.0	25	5.00	4.00	3	4.25
5.5	0.50	62	17.0	26	5.60	4.50	3	5.00
6	0.50	66	19.0	30	6.30	5.00	3	5.50
6	0.75	66	19.0	30	6.30	5.00	3	5.25
7	0.50	66	19.0	30	7.10	5.60	3	6.50
8	0.75	72	22.0	35	8.00	6.30	3	7.25
8	1.00	72	22.0	35	8.00	6.30	3	7.00
9	0.50	72	22.0	36	9.00	7.10	3	8.50
9	0.75	72	22.0	36	9.00	7.10	3	8.25
9	1.00	72	22.0	36	9.00	7.10	3	8.00
10	0.50	80	24.0	39	10.00	8.00	3	9.50
10	1.00	80	24.0	39	10.00	8.00	3	9.00
10	1.25	80	24.0	39	10.00	8.00	3	8.80

ID

ID

ID

102933

102936

* 102938

102940

102945

102949

102952

102773

102953

111040

102958

102960

102778

102961

111045

102963

102967

102783

102969

111050

102784

102971

111051

102975

102790

102982

111057

102791

102984

111058

102988

102989

102990

102925

102756

102928

111024

102758

102930

111025

P 0.25

ISO 1
4H

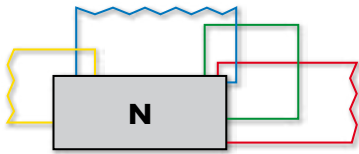

N1210-1

N1210-3

N1210-S

N1210-1

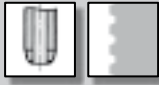

N1210-3



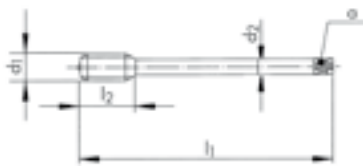

N1210-S



ISO 2
6H

ISO 2
6H

$\varnothing d_1$ MF	P mm	l_1 mm	l_2 mm	d_2 mm	a mm		
11	0.50	85	22.0	8.0	6.3	3	10.50
11	0.75	85	22.0	8.0	6.3	3	10.25
11	1.00	85	22.0	8.0	6.3	3	10.00
11	1.25	85	22.0	8.0	6.3	3	9.80
12	0.50	89	24.0	9.0	7.1	3	11.50
12	0.75	89	24.0	9.0	7.1	3	11.25
12	1.00	89	24.0	9.0	7.1	3	11.00
12	1.25	89	24.0	9.0	7.1	3	10.80
12	1.50	89	24.0	9.0	7.1	3	10.50
14	0.50	95	24.0	11.2	9.0	3	13.50
14	0.75	95	24.0	11.2	9.0	3	13.25
14	1.00	95	24.0	11.2	9.0	3	13.00
14	1.25	95	24.0	11.2	9.0	3	12.80
14	1.50	95	24.0	11.2	9.0	3	12.50
15	0.75	90	23.0	11.2	9.0	3	14.25
15	1.00	90	23.0	11.2	9.0	3	14.00
16	0.50	102	32.0	12.5	10.0	4	15.50
16	0.75	102	32.0	12.5	10.0	4	15.25
16	1.00	102	32.0	12.5	10.0	4	15.00
16	1.50	102	32.0	12.5	10.0	4	14.50
17	1.00	95	23.0	12.5	10.0	4	16.00
18	0.75	112	30.0	14.0	11.2	4	17.25
18	1.00	112	30.0	14.0	11.2	4	17.00
18	1.50	112	30.0	14.0	11.2	4	16.50
18	2.00	112	30.0	14.0	11.2	3	16.00
19	1.00	112	33.0	14.0	11.2	4	18.00

ID

ID

ID

103485

103486

103487

103488

103490

103491

103305

103493

111169

103307

103495

111171

103308

103497

111172

103502

103503

103312

103504

111175

103314

103506

111177

103315

103508

111178

103512

103513

103515

103516

103321

103517

111183

103322

103520

111184

103525

103527

103326

103528

111187

103327





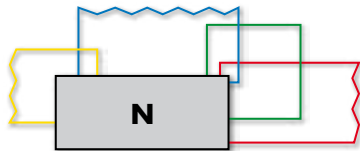

103531

111188

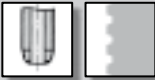
103533



103536

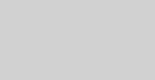



N1210-1			
N1210-3			
N1210-S			



N1210-1	N1210-3	N1210-S	
---------	---------	---------	--

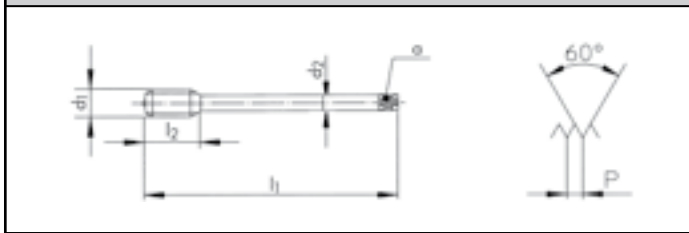

	 <math>< 1.5 \times D</math>	 <math>< 2.5 \times D</math>
---	---	---









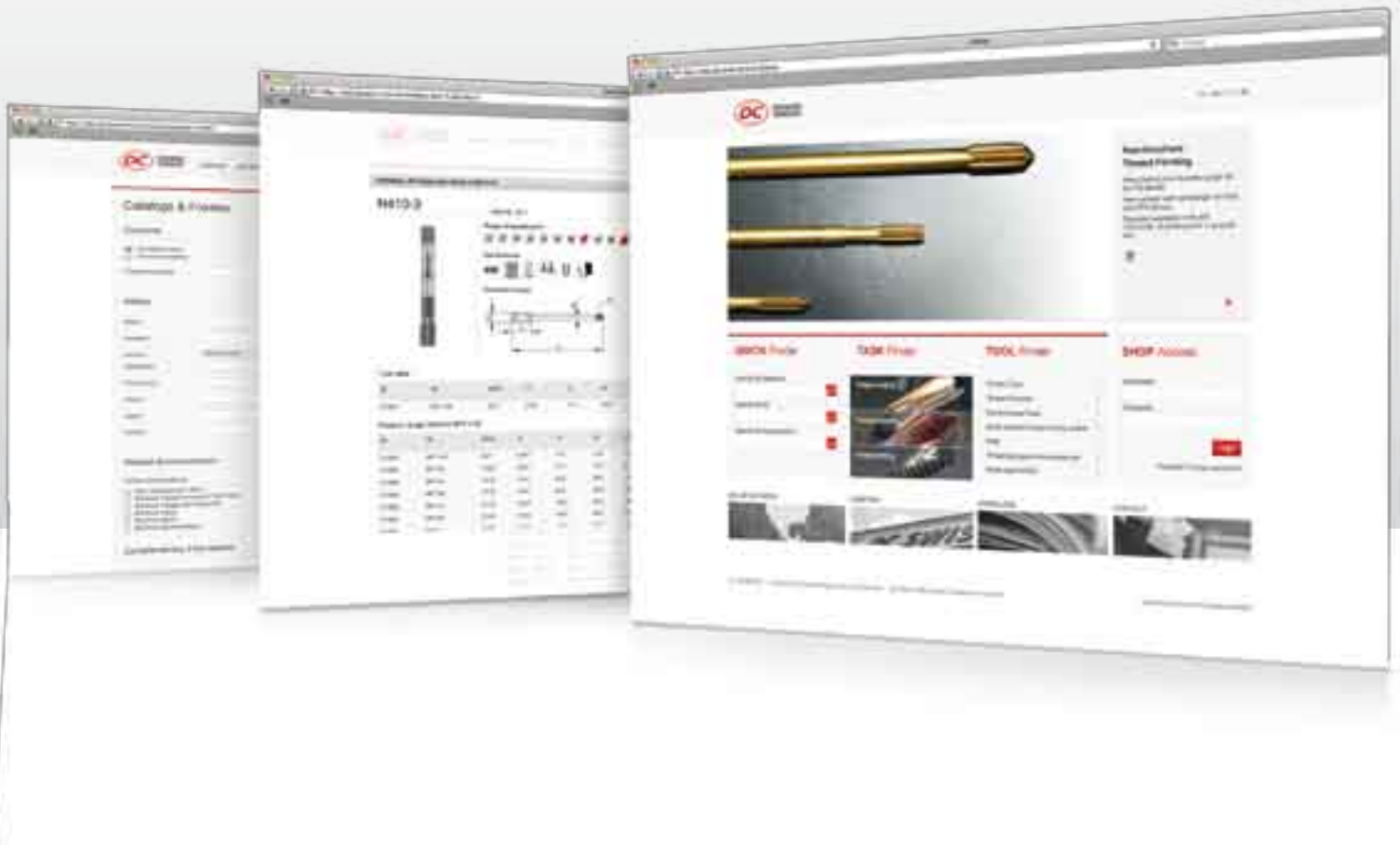





















 5 x P	 C 2 x P	
	ISO 2 6H	ISO 2 6H













$\varnothing d_1$ MF	P mm	l_1 mm	l_2 mm	d_2 mm	α mm			ID	ID	ID
20	1.00	112	37.0	14.0	11.2	4	19.00	103332	103537	111198
20	1.25	112	37.0	14.0	11.2	4	18.80		103539	
20	1.50	112	37.0	14.0	11.2	4	18.50	103334	103540	111195
22	1.00	115	32.0	16.0	12.5	4	21.00		103545	
22	1.50	115	32.0	16.0	12.5	4	20.50	103340	103546	121669
22	2.00	115	32.0	16.0	12.5	3	20.00		103548	
24	1.00	120	30.0	18.0	14.0	4	23.00		103552	
24	1.50	120	30.0	18.0	14.0	4	22.50	103343	103553	111202
24	2.00	130	45.0	18.0	14.0	4	22.00	103344	103555	111203
25	1.00	120	30.0	18.0	14.0	4	24.00		103559	
25	1.50	120	30.0	18.0	14.0	4	23.50		103560	
25	2.00	120	30.0	18.0	14.0	4	23.00		103561	
26	1.00	120	30.0	18.0	14.0	4	25.00		103562	
26	1.50	120	30.0	18.0	14.0	4	24.50	103346	103563	111207
26	2.00	120	30.0	18.0	14.0	4	24.00		103564	
27	1.00	127	30.0	20.0	16.0	4	26.00		103565	
27	1.50	127	30.0	20.0	16.0	4	25.50		103566	
27	2.00	135	45.0	20.0	16.0	4	25.00	* 103351	* 103567	* 111210
28	1.00	127	30.0	20.0	16.0	4	27.00		103570	
28	1.50	127	30.0	20.0	16.0	4	26.50		103571	
30	1.50	127	32.0	20.0	16.0	4	28.50	103355	103575	111214
30	2.00	127	32.0	20.0	16.0	4	28.00	103356	103577	111215

MORE PERSONAL.
MORE ACCURATE.
MORE COMPLETE.
MORE **YOU.**

































DCSWISS.COM

		N					Z	
Характеристики Cechy charakterystyczne				 V	 R40 V	 	 V	 VS
					 	  	 	
Типы отверстий Typ otworu								
		N310-3	N320-3 N320-4	N320V-4	N360-3 N360V-3	N1110 -1-2-3-S	Z320V-3 Z320V-4	Z320VS-4
Длинный по DIN DIN długi	DIN 371	114	114	114	116		118	118
Короткий по ISO ISO krótki	ISO 529					128		
Класс точности Tolerancja	UNC 2B	114	114	114	116	128	118	118
Класс точности Tolerancja	UNC 3B							
Класс точности Tolerancja	UNC(J) 3B		114		116			
		N410-3	N420-4	N420V-4	N460-3 N460V-3	N1210 -1-2-3-S	Z420V-4	Z420VS-4
Длинный по DIN DIN długi	DIN 376	115	115	115	117		118	118
Короткий по ISO ISO krótki	ISO 529					129		
Класс точности Tolerancja	UNC 2B	115	115	115	117	129	118	118
Класс точности Tolerancja	UNC 3B							
Класс точности Tolerancja	UNC(J) 3B							

Z		H		S		SA		
								
								
								
								
Z360V-3 Z362V-3	Z370VS-3	H320-4	H350-3	S320VS-4	S360VS-3	SA320-4	SA350-3	SA390-3
119	120	121	121	122	123	124	124	125
119	120	121	121	122	123	124	124	
	120			122		124	124	125
Z462V-3	Z470VS-3	H420-4	H450-3	S420VS-4	S460VS-3	SA420-4	SA450-3	
119	120	121	121	122	123	125	125	
119	120	121	121	122	123	125	125	











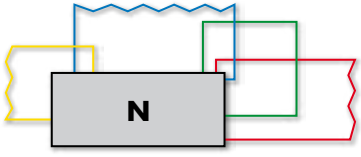







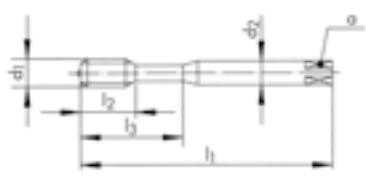
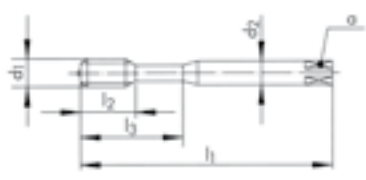











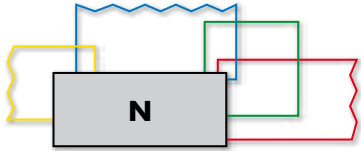











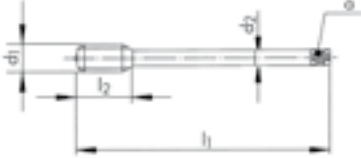

	TL		RTS		FS	FPS	FAS
Характеристики Cechy charakterystyczne							
							
							
Типы отверстий Typ otworu							
	TL320VS-4	TL351VS-3	RTS320VS-4	RTS362VS-3	FS380VS-3	FPS381VS-3	FAS381VS-3
Длинный по DIN DIN długi	DIN 371	124	124	126	126		
Длинный по DIN DIN długi	~ DIN 2184-1				127	127	127
Класс точности Tolerancja	UNC 2B	124	124	126	126	127	127
Класс точности Tolerancja	UNC 3B						
Класс точности Tolerancja	UNC(J) 3B	124	124				
			RTS420VS-4	RTS462VS-3			
Длинный по DIN DIN długi	DIN 376		126	126			
Длинный по DIN DIN długi	~ DIN 2184-1						
Класс точности Tolerancja	UNC 2B		126	126			
Класс точности Tolerancja	UNC 3B						
Класс точности Tolerancja	UNC(J) 3B						

aero

THREADING TOOLS FOR AEROSPACE MATERIALS



										N310-3	N320-4	N320V-4	
													
N310-3													
N320-4													
N320V-4	 												
 													
													
Ø" d ₁ UNC	P TPI	d ₁ mm	l ₁ mm	l ₂ mm	l ₃ mm	d ₂ mm	a mm			ID	ID	ID	
*2	56	2.18	45	9.0		2.8	2.1	2	1.75		101469	143690	
*3	48	2.51	50	10.0		2.8	2.1	2	2.00		101470		
4	40	2.84	56	12.0	18	3.5	2.7	3	2.25	101450	101511	142738	
5	40	3.17	56	12.0	18	3.5	2.7	3	2.55		101512		
6	32	3.50	56	13.0	20	4.0	3.0	3	2.75	101451	101514	144402	
8	32	4.16	63	14.0	21	4.5	3.4	3	3.40	101452	101515	142739	
10	24	4.82	70	15.0	25	6.0	4.9	3	3.80	101449	101508	142740	
12	24	5.48	80	17.0	30	6.0	4.9	3	4.40		101509		
1/4	20	6.35	80	17.0	30	7.0	5.5	3	5.10	101448	101507	142741	
													
Ø" d ₁ UNC	P TPI	d ₁ mm	l ₁ mm	l ₂ mm	l ₃ mm	d ₂ mm	a mm			ID			
4	40	2.84	56	12.0	18	3.5	2.7	3	2.30		145656		
6	32	3.50	56	13.0	20	4.0	3.0	3	2.80		155317		
8	32	4.16	63	14.0	21	4.5	3.4	3	3.45		155319		
* N320-3													

										N410-3	N420-4	N420V-4
										  		
N410-3  										  		
N420-4  												
N420V-4   												
 										  		
										  		
$\varnothing'' d_1$ UNC	P TPI	d_1 mm	l_1 mm	l_2 mm	d_2 mm	a mm				ID	ID	ID
5/16	18	7.93	90	20.0	6.0	4.9	3	6.50		101997	102213	142742
3/8	16	9.52	100	22.0	7.0	5.5	3	8.00		101996	102212	142743
7/16	14	11.11	100	19.0	8.0	6.2	3	9.30			102215	142744
1/2	13	12.70	110	24.0	9.0	7.0	3	10.80		101993	102208	142745
9/16	12	14.28	110	28.0	11.0	9.0	3	12.20			102217	
5/8	11	15.87	110	30.0	12.0	9.0	3	13.60		101998	102214	142746
3/4	10	19.05	125	33.0	14.0	11.0	3	16.60		101995	102211	142747
7/8	9	22.22	140	36.0	18.0	14.5	3	19.50			102216	142748
1	8	25.40	160	39.0	18.0	14.5	4	22.30		101994	102209	142749
1 1/8	7	28.57	180	45.0	22.0	18.0	4	25.00			102205	
1 1/4	7	31.75	180	45.0	22.0	18.0	4	28.20		* 101991	102204	
1 1/2	6	38.10	200	55.0	32.0	24.0	4	34.00		* 101990	102203	
1 3/4	5	44.45	220	59.0	36.0	29.0	4	39.50		* 101992	102206	
2	4.5	50.80	250	67.0	40.0	32.0	4	45.30			102210	







UNC ANSI B1.1

≤ Ø 2.8 > Ø 2.8

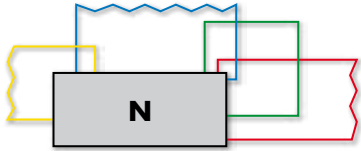
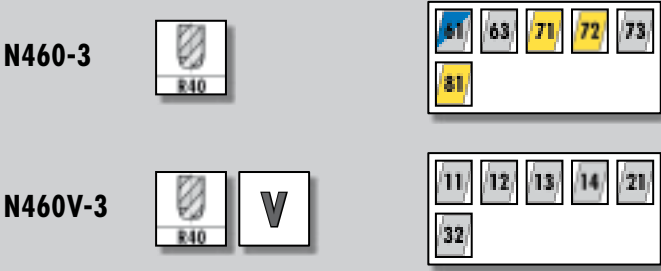
PM **HSSE**

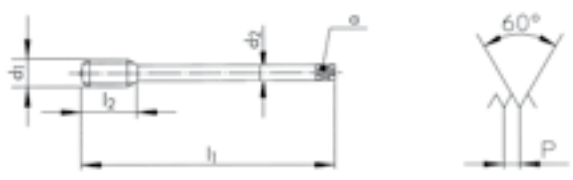

					N360-3	N360V-3	N360-3						
N360-3 													
N360V-3 V													
N360-3 													
\varnothing d ₁ UNC	P TPI	d ₁ mm	l ₁ mm	l ₂ mm	l ₃ mm	d ₂ mm	a mm			ID	ID	ID	
2	56	2.18	45	8.0		2.8	2.1	2	1.75	101673	148887		
3	48	2.51	50	9.0		2.8	2.1	2	2.00	101674			
4	40	2.84	56	5.5	18	3.5	2.7	3	¹ 2.25	101676	101725	155316	
5	40	3.17	56	5.5	18	3.5	2.7	3	2.55	101677			
6	32	3.50	56	6.5	20	4.0	3.0	3	² 2.75	101679	101727	155318	
8	32	4.16	63	7.5	21	4.5	3.4	3	³ 3.40	101680	101728	155320	
10	24	4.82	70	9.0	25	6.0	4.9	3	3.80	101671	101723		
12	24	5.48	80	11.0	30	6.0	4.9	3	4.40	101672			
1/4	20	6.35	80	11.0	30	7.0	5.5	3	5.10	101670	101722		
5/16	18	7.93	90	12.5	35	8.0	6.2	3	6.50	101678	101726		
3/8	16	9.52	100	14.0	39	10.0	8.0	3	8.00	101675	101724		
UNJC ¹ 2.30 ² 2.80 ³ 3.45													

										N460-3	N460V-3		
													
													
													
\varnothing " d_1 UNC	P TPI	d_1 mm	l_1 mm	l_2 mm	d_2 mm	a mm					ID	ID	
7/16	14	11.11	100	14.0	8.0	6.2	3	9.30			102424	105135	
1/2	13	12.70	110	14.0	9.0	7.0	3	10.80			102420	102497	
9/16	12	14.28	110	14.0	11.0	9.0	3	12.20			102426	102502	
5/8	11	15.87	110	18.0	12.0	9.0	3	13.60			102423	102500	
3/4	10	19.05	125	21.0	14.0	11.0	3	16.60			102422	102499	
7/8	9	22.22	140	24.0	18.0	14.5	4	19.50			102425	102501	
1	8	25.40	160	27.0	18.0	14.5	4	22.30			102421	102498	
1 1/8	7	28.57	180	30.0	22.0	18.0	4	25.00			102418	102495	
1 1/4	7	31.75	180	30.0	22.0	18.0	4	28.20			102417	102494	
1 1/2	6	38.10	200	40.0	32.0	24.0	5	34.00			102416	102493	
1 3/4	5	44.45	220	44.0	36.0	29.0	5	39.50				128062	
2	4.5	50.80	250	52.0	40.0	32.0	5	45.30				128084	

										Z320V-4	Z320VS-4	Z420V-4	Z420VS-4
										Z320V-4			21 22 23 41 42 51
Z320VS-4			21 22 23 24 51 61										
Z420V-4			21 22 23 41 42 51										
Z420VS-4			21 22 23 24 51 61										
										2B	2B	2B	2B
\varnothing d ₁ UNC	P TPI	d ₁ mm	l ₁ mm	l ₂ mm	l ₃ mm	d ₂ mm	a mm			ID	ID	ID	ID
*2	56	2.18	45	9.0		2.8	2.1	2	1.75	142750			
4	40	2.84	56	12.0	18	3.5	2.7	3	2.25	142751			
6	32	3.50	56	13.0	20	4.0	3.0	3	2.75	142752	111560		
8	32	4.16	63	14.0	21	4.5	3.4	3	3.40	142753	111561		
10	24	4.82	70	15.0	25	6.0	4.9	3	3.80	142754	111562		
1/4	20	6.35	80	17.0	30	7.0	5.5	3	5.10	142755	111563		
5/16	18	7.93	90	20.0	35	8.0	6.2	3	6.50	142756	111564		
3/8	16	9.52	100	22.0	39	10.0	8.0	3	8.00	142757	111565		
1/2	13	12.70	110	24.0		9.0	7.0	3	10.80			142758	111566
5/8	11	15.87	110	30.0		12.0	9.0	3	13.60			142759	111567
3/4	10	19.05	125	33.0		14.0	11.0	4	16.60			142760	111568
7/8	9	22.22	140	36.0		18.0	14.5	4	19.50			142761	
1	8	25.40	160	39.0		18.0	14.5	4	22.30			142762	

* Z320V-3



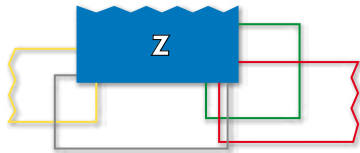
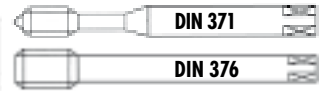

Z362V-3

Z362VS-3

Z462V-3



2B

2BX

2B

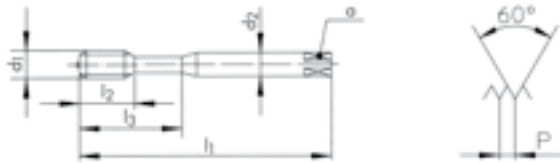

Z362V-3



Z362VS-3



Z462V-3



Ø" d ₁ UNC	P TPI	d ₁ mm	l ₁ mm	l ₂ mm	l ₃ mm	d ₂ mm	a mm		
*2	56	2.18	45	8.0		2.8	2.1	2	1.75
*4	40	2.84	56	5.5	18	3.5	2.7	3	2.25
6	32	3.50	56	6.5	20	4.0	3.0	3	2.75
8	32	4.16	63	7.5	21	4.5	3.4	3	3.40
10	24	4.82	70	9.0	25	6.0	4.9	3	3.80
1/4	20	6.35	80	11.0	30	7.0	5.5	3	5.10
5/16	18	7.93	90	12.5	35	8.0	6.2	3	6.50
3/8	16	9.52	100	14.0	39	10.0	8.0	3	8.00
7/16	14	11.11	100	14.0		8.0	6.2	3	9.30
1/2	13	12.70	110	14.0		9.0	7.0	3	10.80
5/8	11	15.87	110	18.0		12.0	9.0	3	13.60
3/4	10	19.05	125	21.0		14.0	11.0	3	16.60
7/8	9	22.22	140	24.0		18.0	14.5	3	19.50
1	8	25.40	160	27.0		18.0	14.5	4	22.30

* Z360V-3

										Z370VS-3	Z470VS-3		
<p>Z370VS-3</p>													
<p>Z470VS-3</p>													
Ø" d ₁ UNC	P TPI	d ₁ mm	l ₁ mm	l ₂ mm	l ₃ mm	d ₂ h ₆ mm	a mm			ID	ID		
6	32	3.50	56	6.5	20	4.0(h9)	3.0	3	2.75	166123			
8	32	4.16	63	7.5	21	4.5(h9)	3.4	3	3.40	166124			
10	24	4.82	70	9.0	25	6.0	4.9	3	3.80	166125			
1/4	20	6.35	80	11.0	30	*6.0	*4.9	3	5.10	166126			
5/16	18	7.93	90	12.5	35	8.0	6.2	3	6.50	166127			
3/8	16	9.52	100	14.0	39	10.0	8.0	3	8.00	166128			
7/16	14	11.11	100	14.0		8.0	6.2	3	9.30		166129		
1/2	13	12.70	110	14.0		*10.0	*8.0	4	10.80		166130		
5/8	11	15.87	110	18.0		12.0	9.0	4	13.60		166131		
3/4	10	19.05	125	21.0		14.0	11.0	4	16.60		166132		
1	8	25.40	160	27.0		16.0	12.0	4	22.30		175703		
* Norme DC / * DC Norm / * Norma DC													
Ø" d ₁ UNC	P TPI	d ₁ mm	l ₁ mm	l ₂ mm	l ₃ mm	d ₂ h ₆ mm	a mm			ID			
4	40	2.84	56	5.5	18	3.5(h9)	2.7	3	2.30	165114			
6	32	3.50	56	6.5	20	4.0(h9)	3.0	3	2.80	165115			
8	32	4.16	63	7.5	21	4.5(h9)	3.4	3	3.45	165116			
1/4	20	6.35	80	11.0	30	*6.0	*4.9	3	5.20	165117			
5/16	18	7.93	90	12.5	35	8.0	6.2	3	6.70	165118			
* Norme DC / * DC Norm / * Norma DC													

UNC ANSI B1.1

PM

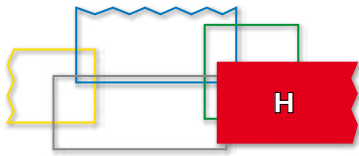
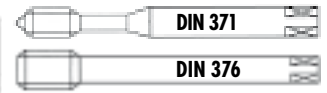

H320-4

H420-4

H350-3

H450-3



H320-4



H420-4



H350-3



H450-3

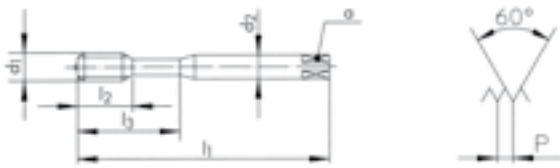

Ø" d ₁ UNC	P TPI	d ₁ mm	l ₁ mm	l ₂ mm	l ₃ mm	d ₂ mm	α mm		
2	56	2.18	45	8.0		2.8	2.1	2	1.75
4	40	2.84	56	10.0	18	3.5	2.7	3	2.25
6	32	3.50	56	13.0	20	4.0	3.0	3	2.75
8	32	4.16	63	14.0	21	4.5	3.4	3	3.40
10	24	4.82	70	15.0	25	6.0	4.9	3	3.80
1/4	20	6.35	80	17.0	30	7.0	5.5	3	5.10
5/16	18	7.93	90	20.0	35	8.0	6.2	3	6.50
3/8	16	9.52	100	22.0	39	10.0	8.0	3	8.00
1/2	13	12.70	110	24.0		9.0	7.0	4	10.80

ID

ID

101221

101223

101225

101226

101220

101219

101224

101222

101290

Ø" d ₁ UNC	P TPI	d ₁ mm	l ₁ mm	l ₂ mm	l ₃ mm	d ₂ mm	α mm		
2	56	2.18	45	8.0		2.8	2.1	2	1.75
4	40	2.84	56	5.5	18	3.5	2.7	3	2.25
6	32	3.50	56	6.5	20	4.0	3.0	3	2.75
8	32	4.16	63	7.5	21	4.5	3.4	3	3.40
10	24	4.82	70	9.0	25	6.0	4.9	3	3.80
1/4	20	6.35	80	11.0	30	7.0	5.5	3	5.10
5/16	18	7.93	90	12.5	35	8.0	6.2	3	6.50
3/8	16	9.52	100	14.0	39	10.0	8.0	3	8.00
7/16	14	11.11	100	14.0		8.0	6.2	3	9.30
1/2	13	12.70	110	14.0		9.0	7.0	4	10.80
5/8	11	15.87	110	18.0		12.0	9.0	4	13.60
3/4	10	19.05	125	21.0		14.0	11.0	4	16.60
1	8	25.40	160	27.0		18.0	14.5	4	22.30

ID

ID

101258

101260

101262

101263

101257

101256

101261

101259

101330

101326

101329

101328

101327

										S320VS-4	S420VS-4		
S320VS-4		VS											
S420VS-4		VS											
										2B	2B		
\varnothing d ₁ UNC	P TPI	d ₁ mm	l ₁ mm	l ₂ mm	l ₃ mm	d ₂ mm	a mm			ID	ID		
6	32	3.50	56	13.0	20	4.0	3.0	3	2.75	111587			
8	32	4.16	63	14.0	21	4.5	3.4	3	3.40	111588			
10	24	4.82	70	15.0	25	6.0	4.9	3	3.80	* 111589			
1/4	20	6.35	80	17.0	30	7.0	5.5	3	5.10	111590			
5/16	18	7.93	90	20.0	35	8.0	6.2	3	6.50	111591			
3/8	16	9.52	100	22.0	39	10.0	8.0	3	8.00	111592			
1/2	13	12.70	110	24.0		9.0	7.0	4	10.80		111593		
5/8	11	15.87	110	30.0		12.0	9.0	4	13.60		111594		
3/4	10	19.05	125	33.0		14.0	11.0	4	16.60		111595		
										3B UNC(J)			
\varnothing d ₁ UNC	P TPI	d ₁ mm	l ₁ mm	l ₂ mm	l ₃ mm	d ₂ mm	a mm			ID			
4	40	2.84	56	12.0	18	3.5	2.7	3	2.30	165314			
6	32	3.50	56	13.0	20	4.0	3.0	3	2.80	165315			
8	32	4.16	63	14.0	21	4.5	3.4	3	3.45	165316			
1/4	20	6.35	80	17.0	30	7.0	5.5	3	5.20	165317			
5/16	18	7.93	90	20.0	35	8.0	6.2	3	6.70	* 143761			

											S360VS-3	S460VS-3		
											<div style="display: flex; justify-content: space-between;"> <div style="width: 45%;"> <p>S360VS-3</p> <p>S460VS-3</p> </div> <div style="width: 50%; text-align: center;"> </div> </div>			
$\varnothing'' d_1$ UNC	P TPI	d_1 mm	l_1 mm	l_2 mm	l_3 mm	d_2 mm	a mm				ID	ID		
6	32	3.50	56	6.5	20	4.0	3.0	3	2.75		111530			
8	32	4.16	63	7.5	21	4.5	3.4	3	3.40		111531			
10	24	4.82	70	9.0	25	6.0	4.9	3	3.80		* 111532			
1/4	20	6.35	80	11.0	30	7.0	5.5	3	5.10		111533			
5/16	18	7.93	90	12.5	35	8.0	6.2	3	6.50		111534			
3/8	16	9.52	100	14.0	39	10.0	8.0	3	8.00		111535			
1/2	13	12.70	110	14.0		9.0	7.0	4	10.80			111537		
3/4	10	19.05	125	21.0		14.0	11.0	4	16.60			* 111539		

aero

										SA320-4	SA350-3	TL320VS-4	TL351VS-3
\varnothing " d ₁ UNC	P TPI	d ₁ mm	l ₁ mm	l ₂ mm	l ₃ mm	d ₂ mm	a mm			ID	ID	ID	ID
4	40	2.84	56	12.0		3.5	2.7	3	2.25	147271	149003		152018
5	40	3.17	56	12.0		3.5	2.7	3	2.55	* 149031	* 149033	* 152023	* 152024
6	32	3.50	56	13.0		4.0	3.0	3	2.75	149055	149057	* 152027	152028
8	32	4.16	63	14.0		4.5	3.4	3	3.40	149093	149095	* 152036	152037
10	24	4.82	70	15.0		6.0	4.9	3	3.80	149125	* 149127	* 152042	* 152043
1/4	20	6.35	80	15.0	23	7.0	5.5	3	5.10	149222	149224	* 152062	127972
5/16	18	7.93	90	18.0	29	8.0	6.2	3	6.50	149269	149271		152068
3/8	16	9.52	100	20.0	33	10.0	8.0	3	8.00	149346	149348	* 152084	152085
\varnothing " d ₁ UNC	P TPI	d ₁ mm	l ₁ mm	l ₂ mm	l ₃ mm	d ₂ mm	a mm			ID	ID	ID	ID
4	40	2.84	56	12.0		3.5	2.7	3	2.30	149005	149007	* 148804	150194
6	32	3.50	56	13.0		4.0	3.0	3	2.80	149059	149061	* 152029	150210
8	32	4.16	63	14.0		4.5	3.4	3	3.45	149097	149099	* 152038	152039
10	24	4.82	70	15.0		6.0	4.9	3	3.90	* 149129	* 149131		* 152045
1/4	20	6.35	80	15.0	23	7.0	5.5	3	5.20	149226	149228	* 152063	152064
5/16	18	7.93	90	18.0	29	8.0	6.2	3	6.70	149273	149275	* 152069	152070
3/8	16	9.52	100	20.0	33	10.0	8.0	3	8.10	149350	149352	* 152086	152087

aero

SA420-4

SA450-3

SA390-3

SA420-4



SA450-3



SA390-3

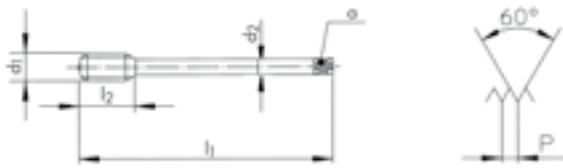

$\varnothing'' d_1$ UNC	P TPI	d_1 mm	l_1 mm	l_2 mm	d_2 mm	a mm		
7/16	14	11.11	100	22.0	8.0	6.2	3	9.30
1/2	13	12.70	110	24.0	9.0	7.0	4	10.80
5/8	11	15.87	110	30.0	12.0	9.0	4	13.60
3/4	10	19.05	125	33.0	14.0	11.0	4	16.60

ID

ID

* 152246

152247

152252

152249

152254

* 152250

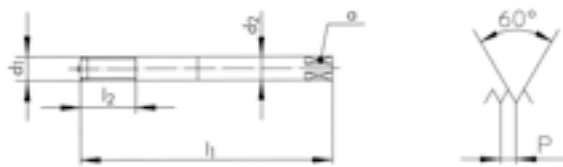

$\varnothing'' d_1$ UNC	P TPI	d_1 mm	l_1 mm	l_2 mm	d_2 mm	a mm		
4	40	2.84	56	12.0	3.5	2.7	3	2.30
6	32	3.50	56	13.0	4.0	3.0	3	2.80
8	32	4.16	63	14.0	4.5	3.4	3	3.45
10	24	4.82	70	15.0	6.0	4.9	3	3.90
1/4	20	6.35	80	20.0	7.0	5.5	3	5.20
5/16	18	7.93	90	25.0	8.0	6.2	3	6.70
3/8	16	9.52	100	30.0	10.0	8.0	3	8.10

3B
UNC(J)

ID

149652

149666

149677

149685

149713

149726

149747



Uniquement pour taraudage synchrone
Nur für Synchrobearbeitung
Only for rigid tapping
Solo per maschiatura sincrona
Solo para roscado sincronizado

PM

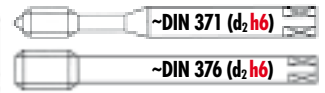

RTS Rigid Tapping Synchro

RTS320VS-4

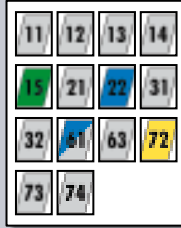

RTS420VS-4



RTS362VS-3

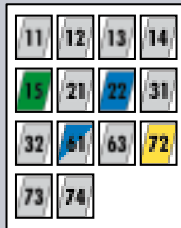

RTS462VS-3



RTS320VS-4

RTS420VS-4

RTS362VS-3

RTS462VS-3

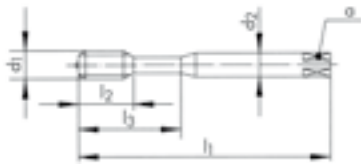

Ø" d ₁ UNC	P TPI	d ₁ mm	l ₁ mm	l ₂ mm	l ₃ mm	d ₂ h6 mm	α mm		
6	32	3.50	56	6.5	20	4.0(h9)	3.0	3	2.75
8	32	4.16	63	7.5	21	4.5(h9)	3.4	3	3.40
10	24	4.82	70	9.0	25	6.0	4.9	3	3.80
1/4	20	6.35	80	11.0	30	*6.0	*4.9	3	5.10
5/16	18	7.93	90	12.5	35	8.0	6.2	3	6.50
3/8	16	9.52	100	14.0	39	10.0	8.0	3	8.00
1/2	13	12.70	110	14.0		*10.0	*8.0	3	10.80

ID	ID	ID	ID
157395		157402	
157396		157403	
157397		157404	
157398		157405	
157399		157406	
157400		157407	
	157401		157408

* Norme DC / * DC Norm / * Norma DC



sur demande
auf Anfrage
on request
su richiesta
sobre pedido

FS FPS FAS FORMING

FS380VS-3 **VS**

11	12	13	14
15	21	22	23
24	41	51	81
63	71	72	73

FPS381VS-3 **VS**

11	12	13	14	15
21	24	63		

FAS381VS-3 **VS**

12	13	14	15	21	22
23	24	41	51	81	63

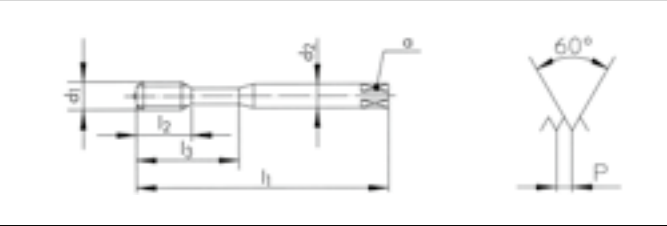





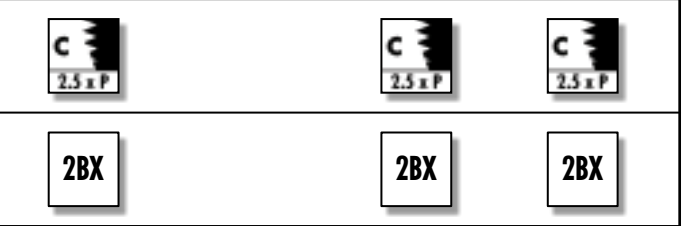
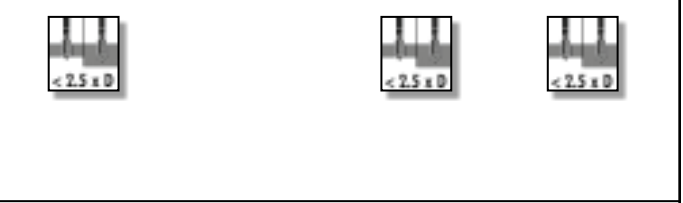



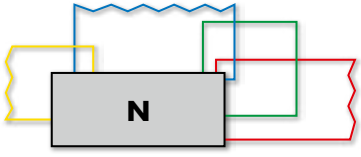

Ø" d ₁ UNC	P TPI	d ₁ mm	l ₁ mm	l ₂ mm	l ₃ mm	d ₂ mm	α mm	2BX Tol. → ←
2	56	2.18	45	9.0		2.8	2.1	1.95 + 0.02
4	40	2.84	56	12.0	18	3.5	2.7	2.55 + 0.03
6	32	3.50	56	13.0	20	4.0	3.0	3.15 + 0.03
8	32	4.16	63	14.0	21	4.5	3.4	3.80 + 0.03
10	24	4.82	70	15.0	25	6.0	4.9	4.35 + 0.05
1/4	20	6.35	80	17.0	30	7.0	5.5	5.75 + 0.05
5/16	18	7.93	90	20.0	35	8.0	6.2	7.30 + 0.05

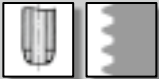
FS380VS-3		FPS381VS-3	FAS381VS-3
-----------	--	------------	------------

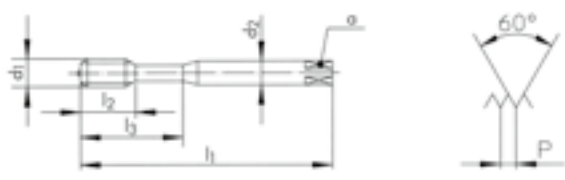

ID	ID	ID
157285		
	170063	170065
	166713	166725
	166714	166726
	166715	166727
	166716	166728
	* 166717	* 166729

UNC

										N1110-1	N1110-2	N1110-3	N1110-S
										<p>N1110-1 </p> <p>N1110-2 </p> <p>N1110-3  </p> <p>N1110-S </p>			
													
												2B	2B
Ø" d ₁ UNC	P TPI	d ₁ mm	l ₁ mm	l ₂ mm	l ₃ mm	d ₂ mm	a mm			ID	ID	ID	ID
2	56	2.18	45	9.5		2.80	2.10	3	1.75	102799	102885	102998	111067
3	48	2.51	45	9.5		2.80	2.10	3	2.00	* 102800	* 102886	* 102999	* 111068
4	40	2.84	48	11.0	18	3.15	2.50	3	2.25	102802	102888	103001	111070
5	40	3.17	48	11.0	18	3.15	2.50	3	2.55			103002	
6	32	3.50	50	13.0	20	3.55	2.80	3	2.75	102805	102891	103004	111073
8	32	4.16	53	13.0	21	4.50	3.55	3	3.40	102806	102892	103005	111074
10	24	4.82	58	16.0	25	5.00	4.00	3	3.80	102797	102883	102996	111065
1/4	20	6.35	66	19.0	30	6.30	5.00	3	5.10	102796	102882	102995	111064
5/16	18	7.93	72	22.0	35	8.00	6.30	3	6.50	102804	102890	103003	111072
3/8	16	9.52	80	24.0	39	10.00	8.00	3	8.00	102801	102887	103000	111069

										N1210-1	N1210-2	N1210-3	N1210-S
N1210-1													
N1210-2													
N1210-3													
N1210-S													
												2B	2B
\varnothing " d ₁ UNC	P TPI	d ₁ mm	l ₁ mm	l ₂ mm	d ₂ mm	a mm				ID	ID	ID	ID
7/16	14	11.11	85	22.0	8.0	6.3	3	9.30		103392	103466	103606	111236
1/2	13	12.70	89	24.0	9.0	7.1	3	10.80		103387	103461	103601	111229
5/8	11	15.87	102	32.0	12.5	10.0	3	13.60		103391	103465	103605	111235
3/4	10	19.05	112	33.0	14.0	11.2	3	16.60		103390	103464	103604	111234
1	8	25.40	130	45.0	18.0	14.0	4	22.30		103388	103462	103602	111230

UNF, UNEF, UNS, UN

Указатель – Машинные и ручные метчики, ANSI B1.1
Skorowidz – Gwintowniki maszynowe i ręczne ANSI B1.1

		N						
Характеристики Cechy charakterystyczne				 V	 E40	 E40 V	 	
								
Типы отверстий Typ otworu								
		N310-3	N320-3 N320-4	N320V-4	N360-3	N360V-3	N1110 -1-3-S	N1120-4
Длинный по DIN DIN długi	DIN 371	134	134	134	136	136		
Короткий по ISO ISO krótki	ISO 529						148	150
Класс точности Tolerancja	UNF 2B	134	134	134	136	136	148	
Класс точности Tolerancja	UNJF 3B							
Класс точности Tolerancja	UNF(J) 3B		134		136			
Класс точности Tolerancja	UNEF 2B						150	150
Класс точности Tolerancja	UNS 2B							
Класс точности Tolerancja	UN 2B							
		N410-3	N420-4	N420V-4	N460-3	N460V-3	N1210 -1-3-S	N1220-4
Длинный по DIN DIN długi	DIN 374	135/151	135	135	137	137		
Короткий по ISO ISO krótki	ISO 529						149	150
Класс точности Tolerancja	UNF 2B	135	135	135	137	137	149	
Класс точности Tolerancja	UNJF 3B							
Класс точности Tolerancja	UNF(J) 3B		135		137			
Класс точности Tolerancja	UNEF 2B						150	150
Класс точности Tolerancja	UNS 2B	151			151	151		
Класс точности Tolerancja	UN 2B				151	151		





















UNF, UNJF

Указатель - Машинные метчики, ANSI B1.1 / ASME B1.15

Spis treści - Gwintowniki maszynowe ANSI B1.1 / ASME B1.15

Z			H		S		SA	
								
V	V	VS			VS	VS		
								
								
Z320V-4	Z360V-3	Z370VS-3	H320-4	H350-3	S320VS-4	S360VS-3	SA320-4	SA320-4
138	138	139	140	141	142	142	143	145
138	138	139	140	141		142	143	145
		139			142	142	143	
Z420V-4	Z460V-3	Z470VS-3	H420-4	H450-3	S420VS-4	S460VS-3	SA420-4	
138	138	139	140	141	142	142	144	
138	138	139	140	141		142	144	
					142	142	144	









UNF, UNJF, UNS, UN

	SA		TL		RTS		
Характеристики Cechy charakterystyczne			 VS	  VS	 VS	 VS	
							
Типы отверстий Typ otworu							
	SA350-3	SA390-3	TL320VS-4	TL351VS-3	RTS320VS-4	RTS362VS-3	
Длинный по DIN DIN długi	DIN 371	143	145	143	143	146	146
Длинный по DIN DIN długi	~ DIN 2184-1						
Класс точности Tolerancja	UNF 2B	143		143	143	146	146
Класс точности Tolerancja	UNF(J) 3B	143	145	143	143		
Класс точности Tolerancja	UNEF 2B						
Класс точности Tolerancja	UNS 2B						
Класс точности Tolerancja	UN 2B						
	SA450-3		TL420VS-4	TL451VS-3	RTS420VS-4	RTS462VS-3	
Длинный по DIN DIN długi	DIN 374	144		144	144	146	146
Длинный по DIN DIN długi	~ DIN 2184-1						
Класс точности Tolerancja	UNF 2B	144			144	146	146
Класс точности Tolerancja	UNF(J) 3B	144		144	144		
Класс точности Tolerancja	UNEF 2B						
Класс точности Tolerancja	UNS 2B						
Класс точности Tolerancja	UN 2B						

UNF

Указатель – Машинные раскатники, ANSI B1.1

Skorowidz – Wygniataki do gwintów ANSI B1.1

FS	FPS	FAS
		
VS	VS	VS
		
		
FS380VS-3	FPS381VS-3	FAS381VS-3
147	147	147
147	147	147



UNF,
UNJF, UNS, UN

www.dcswiss.com



UNF ANSI B1.1

≤ Ø 2.8 > Ø 2.8

PM **HSSE**



										N310-3	N320-3	N320-4	N320V-4
N310-3													
N320-3													
N320-4													
N320V-4	V												
Ø" d ₁ UNF	P TPI	d ₁ mm	l ₁ mm	l ₂ mm	l ₃ mm	d ₂ mm	a mm			ID	ID	ID	ID
0	80	1.52	40	7.0		2.5	2.1	2	1.20		101475		
1	72	1.85	40	8.0		2.5	2.1	2	1.50		* 101476		
2	64	2.18	45	9.0		2.8	2.1	2	1.80		101477		
4	48	2.84	56	12.0	18	3.5	2.7	3	2.35			128847	
5	44	3.17	56	12.0	18	3.5	2.7	3	2.60			142764	
6	40	3.50	56	13.0	20	4.0	3.0	3	2.90			101519	142765
8	36	4.16	63	14.0	21	4.5	3.4	3	3.50			101520	
10	32	4.82	70	15.0	25	6.0	4.9	3	4.05			101517	142766
12	28	5.48	80	17.0	30	6.0	4.9	3	4.60			101518	
1/4	28	6.35	80	17.0	30	7.0	5.5	3	5.50	101453		101516	142767
Ø" d ₁ UNF	P TPI	d ₁ mm	l ₁ mm	l ₂ mm	l ₃ mm	d ₂ mm	a mm			ID			
10	32	4.82	70	15.0	25	6.0	4.9	3	4.15		135506		
1/4	28	6.35	80	17.0	30	7.0	5.5	3	5.55		155323		











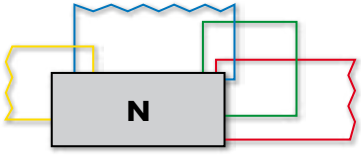







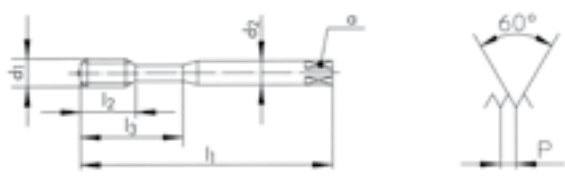

UNF ANSI B1.1

HSSE



										N410-3	N420-4	N420V-4	
N410-3													
N420-4													
N420V-4													
$\varnothing'' d_1$ UNF	P TPI	d_1 mm	l_1 mm	l_2 mm	d_2 mm	a mm			$\rightarrow \leftarrow$	ID	ID	ID	
5/16	24	7.93	90	20.0	6.0	4.9	3	6.90		102004	102223	142774	
3/8	24	9.52	100	22.0	7.0	5.5	3	8.50		102003	102222	142775	
7/16	20	11.11	100	19.0	8.0	6.2	3	9.80		102006	102225	142776	
1/2	20	12.70	100	24.0	9.0	7.0	3	11.40		102000	102219	142777	
9/16	18	14.28	100	24.0	11.0	9.0	3	12.90			102227		
5/8	18	15.87	100	26.0	12.0	9.0	3	14.50		102005	102224	142778	
3/4	16	19.05	125	33.0	14.0	11.0	4	17.50		102002	102221	142779	
7/8	14	22.22	140	36.0	18.0	14.5	4	20.40		* 102007	102226		
1	12	25.40	160	39.0	18.0	14.5	4	23.30			102220	142780	
1 1/8	12	28.57	180	39.0	22.0	18.0	4	26.50			142773		
1 1/4	12	31.75	180	39.0	22.0	18.0	4	29.70			102218		
1 3/8	12	34.92	200	36.0	28.0	22.0	4	32.80			105137		
1 1/2	12	38.10	200	41.0	32.0	24.0	4	36.00		* 110986	105138		
$\varnothing'' d_1$ UNF	P TPI	d_1 mm	l_1 mm	l_2 mm	d_2 mm	a mm			UNF	ID			
5/16	24	7.93	90	20.0	6.0	4.9	3	7.00			155328		
3/8	24	9.52	100	22.0	7.0	5.5	3	8.60			155326		
7/16	20	11.11	100	19.0	8.0	6.2	3	10.00			155330		
1/2	20	12.70	100	24.0	9.0	7.0	3	11.55			155321		

UNF

										N360-3	N360V-3						
										 							
N360-3																	
N360V-3	 																
																	
																	
																	
\varnothing d ₁ UNF	P TPI	d ₁ mm	l ₁ mm	l ₂ mm	l ₃ mm	d ₂ mm	a mm			ID	ID						
6	40	3.50	56	6.5	20	4.0	3.0	3	2.90	101686							
8	36	4.16	63	7.5	21	4.5	3.4	3	3.50	* 101687	* 101733						
10	32	4.82	70	9.0	25	6.0	4.9	3	4.05	101682	101730						
12	28	5.48	80	11.0	30	6.0	4.9	3	4.60	101683							
1/4	28	6.35	80	11.0	30	7.0	5.5	3	5.50	101681	101729						
5/16	24	7.93	90	12.5	35	8.0	6.2	3	6.90	101685	101732						
3/8	24	9.52	100	14.0	39	10.0	8.0	3	8.50	101684	101731						
																	
\varnothing d ₁ UNF	P TPI	d ₁ mm	l ₁ mm	l ₂ mm	l ₃ mm	d ₂ mm	a mm			ID							
10	32	4.82	70	9.0	25	6.0	4.9	3	4.15	155325							
1/4	28	6.35	80	11.0	30	7.0	5.5	3	5.55	155324							
5/16	24	7.93	90	12.5	35	8.0	6.2	3	7.00	155329							
3/8	24	9.52	100	14.0	39	10.0	8.0	3	8.60	155327							

UNF ANSI B1.1

HSSE



										N460-3	N460V-3						
N460-3 																	
N460V-3 																	
$\varnothing'' d_1$ UNF	P TPI	d_1 mm	l_1 mm	l_2 mm	d_2 mm	a mm				ID	ID						
7/16	20	11.11	100	14.0	8.0	6.2	3	9.80		102434	142781						
1/2	20	12.70	100	14.0	9.0	7.0	3	11.40		102430	102503						
9/16	18	14.28	100	14.0	11.0	9.0	3	12.90		102436	143422						
5/8	18	15.87	100	14.0	12.0	9.0	3	14.50		102433	143097						
3/4	16	19.05	125	18.0	14.0	11.0	4	17.50		102432	102505						
7/8	14	22.22	140	20.0	18.0	14.5	4	20.40		102435	144714						
1	12	25.40	160	27.0	18.0	14.5	4	23.30		102431	102504						
1 1/8	12	28.57	180	24.0	22.0	18.0	4	26.50		102429	144414						
1 1/4	12	31.75	180	24.0	22.0	18.0	4	29.70		102428	151709						
1 1/2	12	38.10	200	30.0	32.0	24.0	5	36.00		102427	148793						
$\varnothing'' d_1$ UNF	P TPI	d_1 mm	l_1 mm	l_2 mm	d_2 mm	a mm				ID							
7/16	20	11.11	100	14.0	8.0	6.2	3	10.00		155331							
1/2	20	12.70	100	14.0	9.0	7.0	3	11.55		155322							

UNF

UNF ANSI B1.1

Z .20

Z .60

PM

HSSE

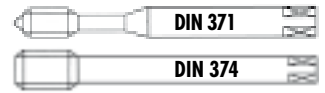

										Z320V-4	Z420V-4	Z360V-3	Z460V-3
$\varnothing'' d_1$ UNF	P TPI	d_1 mm	l_1 mm	l_2 mm	l_3 mm	d_2 mm	a mm			ID	ID		
10	32	4.82	70	15.0	25	6.0	4.9	3	4.05	142783			
1/4	28	6.35	80	17.0	30	7.0	5.5	3	5.50	142784			
5/16	24	7.93	90	20.0	35	8.0	6.2	3	6.90	142785			
3/8	24	9.52	100	22.0	39	10.0	8.0	3	8.50	142786			
7/16	20	11.11	100	19.0		8.0	6.2	3	9.80		142787		
1/2	20	12.70	100	24.0		9.0	7.0	3	11.40		142788		
$\varnothing'' d_1$ UNF	P TPI	d_1 mm	l_1 mm	l_2 mm	l_3 mm	d_2 mm	a mm			ID	ID		
10	32	4.82	70	9.0	25	6.0	4.9	3	4.05	104680			
1/4	28	6.35	80	11.0	30	7.0	5.5	3	5.50	104679			
5/16	24	7.93	90	12.5	35	8.0	6.2	3	6.90	104682			
3/8	24	9.52	100	14.0	39	10.0	8.0	3	8.50	104681			
7/16	20	11.11	100	14.0		8.0	6.2	3	9.80		104741		
1/2	20	12.70	100	14.0		9.0	7.0	3	11.40		104738		
5/8	18	15.87	100	14.0		12.0	9.0	3	14.50		104740		
3/4	16	19.05	125	18.0		14.0	11.0	4	17.50		104739		

UNF ANSI B1.1

PM

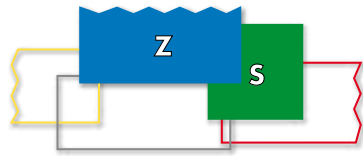
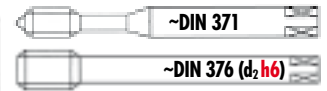

Z370VS-3

Z470VS-3

Z370VS-3

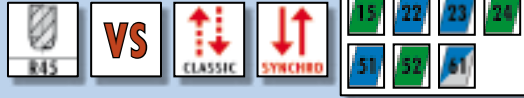

Z470VS-3

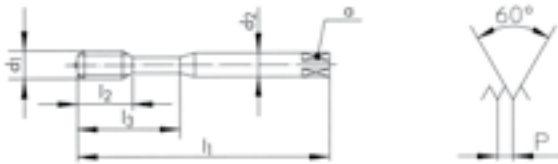

2BX

2BX

$\varnothing'' d_1$ UNF	P TPI	d_1 mm	l_1 mm	l_2 mm	l_3 mm	$d_2 h_6$ mm	α mm		
10	32	4.82	70	9.0	25	6.0	4.9	3	4.05
1/4	28	6.35	80	11.0	30	*6.0	*4.9	3	5.50
5/16	24	7.93	90	12.5	35	8.0	6.2	3	6.90
3/8	24	9.52	100	14.0	39	10.0	8.0	3	8.50
7/16	20	11.11	100	14.0		8.0	6.2	3	9.80
1/2	20	12.70	110	14.0		*10.0	*8.0	4	11.40

ID

ID

166136

166135

166134

166133

166138

166137

* Norme DC / * DC Norm / * Norma DC

3B
UNF(J)

$\varnothing'' d_1$ UNF	P TPI	d_1 mm	l_1 mm	l_2 mm	l_3 mm	$d_2 h_6$ mm	α mm		
10	32	4.82	70	9.0	25	6.0	4.9	3	4.15
1/4	28	6.35	80	11.0	30	*6.0	*4.9	3	5.55
5/16	24	7.93	90	12.5	35	8.0	6.2	3	7.00
3/8	24	9.52	100	14.0	39	10.0	8.0	3	8.60

ID

165121

165122

165123

165124

* Norme DC / * DC Norm / * Norma DC

UNF ANSI B1.1

PM

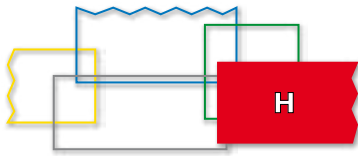
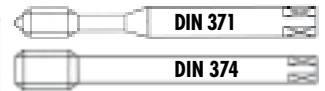

H320-4	H420-4		
--------	--------	--	--

H320-4



H420-4

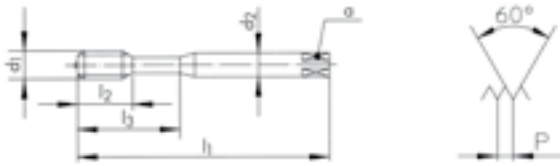

$\varnothing'' d_1$ UNF	P TPI	d_1 mm	l_1 mm	l_2 mm	l_3 mm	d_2 mm	a mm		
10	32	4.82	70	15.0	25	6.0	4.9	3	4.05
1/4	28	6.35	80	17.0	30	7.0	5.5	3	5.50
5/16	24	7.93	90	20.0	35	8.0	6.2	3	6.90
3/8	24	9.52	100	22.0	39	10.0	8.0	3	8.50
1/2	20	12.70	100	24.0		9.0	7.0	4	11.40

ID	ID
101228	
101227	
105139	
101229	
	101291

UNF ANSI B1.1

PM

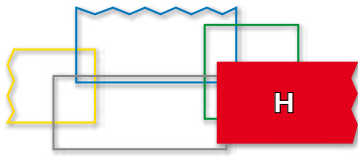
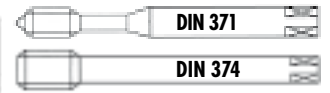

H350-3

H450-3

H350-3



H450-3

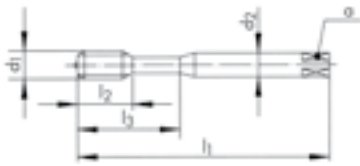

Ø" d ₁ UNF	P TPI	d ₁ mm	l ₁ mm	l ₂ mm	l ₃ mm	d ₂ mm	a mm		
10	32	4.82	70	9.0	25	6.0	4.9	3	4.05
1/4	28	6.35	80	11.0	30	7.0	5.5	3	5.50
5/16	24	7.93	90	12.5	35	8.0	6.2	3	6.90
3/8	24	9.52	100	14.0	39	10.0	8.0	3	8.50
7/16	20	11.11	100	14.0		8.0	6.2	3	9.80
1/2	20	12.70	100	14.0		9.0	7.0	4	11.40
5/8	18	15.87	100	14.0		12.0	9.0	4	14.50
3/4	16	19.05	125	18.0		14.0	11.0	4	17.50

ID

ID

101265

101264

101267

101266

101334

101331

101333









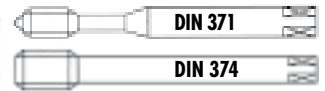

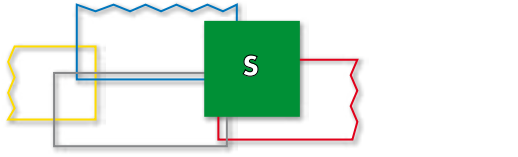









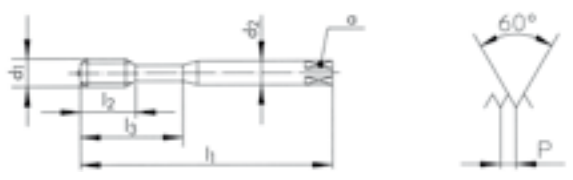





101332

UNF

UNF ANSI B1.1

PM



										S320VS-4	S420VS-4	S360VS-3	S460VS-3
													
S320VS-4		VS											
S420VS-4		VS											
S360VS-3		VS											
S460VS-3		VS											
													
													
$\varnothing'' d_1$ UNF	P TPI	d_1 mm	l_1 mm	l_2 mm	l_3 mm	d_2 mm	α mm			ID	ID		
10	32	4.82	70	15.0	25	6.0	4.9	3	4.15	111814			
1/4	28	6.35	80	17.0	30	7.0	5.5	3	5.55	111813			
5/16	24	7.93	90	20.0	35	8.0	6.2	3	7.00	111816			
3/8	24	9.52	100	22.0	39	10.0	8.0	3	8.60	111818			
7/16	20	11.11	100	22.0		8.0	6.2	3	10.00		111837		
$\varnothing'' d_1$ UNF	P TPI	d_1 mm	l_1 mm	l_2 mm	l_3 mm	d_2 mm	α mm			ID	ID		
10	32	4.82	70	9.0	25	6.0	4.9	3	4.05		* 111581		
1/4	28	6.35	80	11.0	30	7.0	5.5	3	5.50		* 111582		
5/16	24	7.93	90	12.5	35	8.0	6.2	3	6.90		* 111583		
7/16	20	11.11	100	14.0		8.0	6.2	3	9.80		* 111585		
1/2	20	12.70	100	14.0		9.0	7.0	4	11.40		* 111586		
													
$\varnothing'' d_1$ UNF	P TPI	d_1 mm	l_1 mm	l_2 mm	l_3 mm	d_2 mm	α mm			ID	ID		
10	32	4.82	70	9.0	25	6.0	4.9	3	4.15	111815			
1/4	28	6.35	80	11.0	30	7.0	5.5	3	5.55	111820			
5/16	24	7.93	90	12.5	35	8.0	6.2	3	7.00	111817			
3/8	24	9.52	100	14.0	39	10.0	8.0	3	8.60	111819			
7/16	20	11.11	100	14.0		8.0	6.2	3	10.00		111833		

<h1>aero</h1>										SA320-4	SA350-3	TL320VS-4	TL351VS-3																																																																																				
<div style="display: flex; justify-content: space-between;"> <div style="width: 45%;"> <p>SA320-4 52 53</p> <p>SA350-3 52 53</p> <p>TL320VS-4 VS 41 42</p> <p>TL351VS-3 VS 41 42</p> </div> <div style="width: 50%; text-align: center;"> </div> </div>																																																																																																	
										<div style="display: flex; justify-content: space-around;"> <div style="border: 1px solid black; padding: 5px;">2B</div> <div style="border: 1px solid black; padding: 5px;">2B</div> <div style="border: 1px solid black; padding: 5px;">2B</div> <div style="border: 1px solid black; padding: 5px;">2B</div> </div>																																																																																							
<table border="1" style="width: 100%; border-collapse: collapse;"> <thead> <tr> <th>Ø" d₁ UNF</th> <th>P TPI</th> <th>d₁ mm</th> <th>l₁ mm</th> <th>l₂ mm</th> <th>l₃ mm</th> <th>d₂ mm</th> <th>a mm</th> <th></th> <th></th> </tr> </thead> <tbody> <tr><td>10</td><td>32</td><td>4.82</td><td>70</td><td>15.0</td><td></td><td>6.0</td><td>4.9</td><td>3</td><td>4.05</td></tr> <tr><td>1/4</td><td>28</td><td>6.35</td><td>80</td><td>15.0</td><td>23</td><td>7.0</td><td>5.5</td><td>3</td><td>5.50</td></tr> <tr><td>5/16</td><td>24</td><td>7.93</td><td>90</td><td>18.0</td><td>29</td><td>8.0</td><td>6.2</td><td>3</td><td>6.90</td></tr> <tr><td>3/8</td><td>24</td><td>9.52</td><td>100</td><td>20.0</td><td>33</td><td>10.0</td><td>8.0</td><td>3</td><td>8.50</td></tr> </tbody> </table>										Ø" d ₁ UNF	P TPI	d ₁ mm	l ₁ mm	l ₂ mm	l ₃ mm	d ₂ mm	a mm			10	32	4.82	70	15.0		6.0	4.9	3	4.05	1/4	28	6.35	80	15.0	23	7.0	5.5	3	5.50	5/16	24	7.93	90	18.0	29	8.0	6.2	3	6.90	3/8	24	9.52	100	20.0	33	10.0	8.0	3	8.50	<table border="1" style="width: 100%; border-collapse: collapse;"> <thead> <tr> <th>ID</th> <th>ID</th> <th>ID</th> <th>ID</th> </tr> </thead> <tbody> <tr><td>149133</td><td>149135</td><td>* 152046</td><td>152047</td></tr> <tr><td>149230</td><td>149232</td><td>* 152065</td><td>152066</td></tr> <tr><td>149277</td><td>149279</td><td>* 152071</td><td>152072</td></tr> <tr><td>149339</td><td>149341</td><td>* 152082</td><td>152083</td></tr> </tbody> </table>				ID	ID	ID	ID	149133	149135	* 152046	152047	149230	149232	* 152065	152066	149277	149279	* 152071	152072	149339	149341	* 152082	152083														
Ø" d ₁ UNF	P TPI	d ₁ mm	l ₁ mm	l ₂ mm	l ₃ mm	d ₂ mm	a mm																																																																																										
10	32	4.82	70	15.0		6.0	4.9	3	4.05																																																																																								
1/4	28	6.35	80	15.0	23	7.0	5.5	3	5.50																																																																																								
5/16	24	7.93	90	18.0	29	8.0	6.2	3	6.90																																																																																								
3/8	24	9.52	100	20.0	33	10.0	8.0	3	8.50																																																																																								
ID	ID	ID	ID																																																																																														
149133	149135	* 152046	152047																																																																																														
149230	149232	* 152065	152066																																																																																														
149277	149279	* 152071	152072																																																																																														
149339	149341	* 152082	152083																																																																																														
										<div style="display: flex; justify-content: space-around;"> <div style="border: 1px solid black; padding: 5px;">3B UNF(J)</div> <div style="border: 1px solid black; padding: 5px;">3B UNF(J)</div> <div style="border: 1px solid black; padding: 5px;">3B UNF(J)</div> <div style="border: 1px solid black; padding: 5px;">3B UNF(J)</div> </div>																																																																																							
<table border="1" style="width: 100%; border-collapse: collapse;"> <thead> <tr> <th>Ø" d₁ UNF</th> <th>P TPI</th> <th>d₁ mm</th> <th>l₁ mm</th> <th>l₂ mm</th> <th>l₃ mm</th> <th>d₂ mm</th> <th>a mm</th> <th></th> <th></th> </tr> </thead> <tbody> <tr><td>4</td><td>48</td><td>2.84</td><td>56</td><td>12.0</td><td></td><td>3.5</td><td>2.7</td><td>3</td><td>2.35</td></tr> <tr><td>10</td><td>32</td><td>4.82</td><td>70</td><td>15.0</td><td></td><td>6.0</td><td>4.9</td><td>3</td><td>4.15</td></tr> <tr><td>1/4</td><td>28</td><td>6.35</td><td>80</td><td>15.0</td><td>23</td><td>7.0</td><td>5.5</td><td>3</td><td>5.55</td></tr> <tr><td>5/16</td><td>24</td><td>7.93</td><td>90</td><td>18.0</td><td>29</td><td>8.0</td><td>6.2</td><td>3</td><td>7.00</td></tr> <tr><td>3/8</td><td>24</td><td>9.52</td><td>100</td><td>20.0</td><td>33</td><td>10.0</td><td>8.0</td><td>3</td><td>8.60</td></tr> </tbody> </table>										Ø" d ₁ UNF	P TPI	d ₁ mm	l ₁ mm	l ₂ mm	l ₃ mm	d ₂ mm	a mm			4	48	2.84	56	12.0		3.5	2.7	3	2.35	10	32	4.82	70	15.0		6.0	4.9	3	4.15	1/4	28	6.35	80	15.0	23	7.0	5.5	3	5.55	5/16	24	7.93	90	18.0	29	8.0	6.2	3	7.00	3/8	24	9.52	100	20.0	33	10.0	8.0	3	8.60	<table border="1" style="width: 100%; border-collapse: collapse;"> <thead> <tr> <th>ID</th> <th>ID</th> <th>ID</th> <th>ID</th> </tr> </thead> <tbody> <tr><td></td><td>149015</td><td></td><td></td></tr> <tr><td>146098</td><td>149138</td><td>* 148005</td><td>148004</td></tr> <tr><td>146404</td><td>149235</td><td>* 148013</td><td>148012</td></tr> <tr><td>146393</td><td>149282</td><td>* 148017</td><td>148016</td></tr> <tr><td>147165</td><td>149344</td><td>* 148024</td><td>148023</td></tr> </tbody> </table>				ID	ID	ID	ID		149015			146098	149138	* 148005	148004	146404	149235	* 148013	148012	146393	149282	* 148017	148016	147165	149344	* 148024	148023
Ø" d ₁ UNF	P TPI	d ₁ mm	l ₁ mm	l ₂ mm	l ₃ mm	d ₂ mm	a mm																																																																																										
4	48	2.84	56	12.0		3.5	2.7	3	2.35																																																																																								
10	32	4.82	70	15.0		6.0	4.9	3	4.15																																																																																								
1/4	28	6.35	80	15.0	23	7.0	5.5	3	5.55																																																																																								
5/16	24	7.93	90	18.0	29	8.0	6.2	3	7.00																																																																																								
3/8	24	9.52	100	20.0	33	10.0	8.0	3	8.60																																																																																								
ID	ID	ID	ID																																																																																														
	149015																																																																																																
146098	149138	* 148005	148004																																																																																														
146404	149235	* 148013	148012																																																																																														
146393	149282	* 148017	148016																																																																																														
147165	149344	* 148024	148023																																																																																														

aero

										SA420-4	SA450-3	TL420VS-4	TL451VS-3																																																																																
<table border="1"> <thead> <tr> <th>\varnothing" d_1</th> <th>P</th> <th>d_1</th> <th>l_1</th> <th>l_2</th> <th>d_2</th> <th>α</th> <th></th> <th></th> <th></th> </tr> <tr> <th>UNF</th> <th>TPI</th> <th>mm</th> <th>mm</th> <th>mm</th> <th>mm</th> <th>mm</th> <th></th> <th></th> <th></th> </tr> </thead> <tbody> <tr> <td>7/16</td> <td>20</td> <td>11.11</td> <td>100</td> <td>22.0</td> <td>8.0</td> <td>6.2</td> <td>* 4</td> <td>9.80</td> <td>ID</td> </tr> <tr> <td>1/2</td> <td>20</td> <td>12.70</td> <td>100</td> <td>24.0</td> <td>9.0</td> <td>7.0</td> <td>4</td> <td>11.40</td> <td>ID</td> </tr> <tr> <td>9/16</td> <td>18</td> <td>14.28</td> <td>100</td> <td>24.0</td> <td>11.0</td> <td>9.0</td> <td>4</td> <td>12.90</td> <td>ID</td> </tr> <tr> <td>5/8</td> <td>18</td> <td>15.87</td> <td>100</td> <td>26.0</td> <td>12.0</td> <td>9.0</td> <td>4</td> <td>14.50</td> <td>ID</td> </tr> </tbody> </table>										\varnothing " d_1	P	d_1	l_1	l_2	d_2	α				UNF	TPI	mm	mm	mm	mm	mm				7/16	20	11.11	100	22.0	8.0	6.2	* 4	9.80	ID	1/2	20	12.70	100	24.0	9.0	7.0	4	11.40	ID	9/16	18	14.28	100	24.0	11.0	9.0	4	12.90	ID	5/8	18	15.87	100	26.0	12.0	9.0	4	14.50	ID	<table border="1"> <thead> <tr> <th>ID</th> <th>ID</th> <th>ID</th> <th>ID</th> </tr> </thead> <tbody> <tr> <td>152286</td> <td>152290</td> <td></td> <td>* 152298</td> </tr> <tr> <td>152287</td> <td>152291</td> <td></td> <td>* 152299</td> </tr> <tr> <td>* 152288</td> <td></td> <td></td> <td></td> </tr> <tr> <td>* 152289</td> <td></td> <td></td> <td></td> </tr> </tbody> </table>				ID	ID	ID	ID	152286	152290		* 152298	152287	152291		* 152299	* 152288				* 152289			
\varnothing " d_1	P	d_1	l_1	l_2	d_2	α																																																																																							
UNF	TPI	mm	mm	mm	mm	mm																																																																																							
7/16	20	11.11	100	22.0	8.0	6.2	* 4	9.80	ID																																																																																				
1/2	20	12.70	100	24.0	9.0	7.0	4	11.40	ID																																																																																				
9/16	18	14.28	100	24.0	11.0	9.0	4	12.90	ID																																																																																				
5/8	18	15.87	100	26.0	12.0	9.0	4	14.50	ID																																																																																				
ID	ID	ID	ID																																																																																										
152286	152290		* 152298																																																																																										
152287	152291		* 152299																																																																																										
* 152288																																																																																													
* 152289																																																																																													
										<table border="1"> <thead> <tr> <th>2B</th> <th>2B</th> <th>2B</th> <th>2B</th> </tr> </thead> <tbody> <tr> <td></td> <td></td> <td></td> <td></td> </tr> </tbody> </table>				2B	2B	2B	2B																																																																												
2B	2B	2B	2B																																																																																										
										<table border="1"> <thead> <tr> <th>3B UNF(J)</th> <th>3B UNF(J)</th> <th>3B UNF(J)</th> <th>3B UNF(J)</th> </tr> </thead> <tbody> <tr> <td></td> <td></td> <td></td> <td></td> </tr> </tbody> </table>				3B UNF(J)	3B UNF(J)	3B UNF(J)	3B UNF(J)																																																																												
3B UNF(J)	3B UNF(J)	3B UNF(J)	3B UNF(J)																																																																																										
<table border="1"> <thead> <tr> <th>\varnothing" d_1</th> <th>P</th> <th>d_1</th> <th>l_1</th> <th>l_2</th> <th>d_2</th> <th>α</th> <th></th> <th></th> <th></th> </tr> <tr> <th>UNF</th> <th>TPI</th> <th>mm</th> <th>mm</th> <th>mm</th> <th>mm</th> <th>mm</th> <th></th> <th></th> <th></th> </tr> </thead> <tbody> <tr> <td>7/16</td> <td>20</td> <td>11.11</td> <td>100</td> <td>22.0</td> <td>8.0</td> <td>6.2</td> <td>* 4</td> <td>10.00</td> <td>ID</td> </tr> <tr> <td>1/2</td> <td>20</td> <td>12.70</td> <td>100</td> <td>24.0</td> <td>9.0</td> <td>7.0</td> <td>4</td> <td>11.55</td> <td>ID</td> </tr> <tr> <td>9/16</td> <td>18</td> <td>14.28</td> <td>100</td> <td>24.0</td> <td>11.0</td> <td>9.0</td> <td>4</td> <td>13.05</td> <td>ID</td> </tr> <tr> <td>5/8</td> <td>18</td> <td>15.87</td> <td>100</td> <td>26.0</td> <td>12.0</td> <td>9.0</td> <td>4</td> <td>14.60</td> <td>ID</td> </tr> </tbody> </table>										\varnothing " d_1	P	d_1	l_1	l_2	d_2	α				UNF	TPI	mm	mm	mm	mm	mm				7/16	20	11.11	100	22.0	8.0	6.2	* 4	10.00	ID	1/2	20	12.70	100	24.0	9.0	7.0	4	11.55	ID	9/16	18	14.28	100	24.0	11.0	9.0	4	13.05	ID	5/8	18	15.87	100	26.0	12.0	9.0	4	14.60	ID	<table border="1"> <thead> <tr> <th>ID</th> <th>ID</th> <th>ID</th> <th>ID</th> </tr> </thead> <tbody> <tr> <td>147187</td> <td>152302</td> <td>* 152306</td> <td>148031</td> </tr> <tr> <td>147189</td> <td>152303</td> <td>* 152307</td> <td>152310</td> </tr> <tr> <td>146395</td> <td></td> <td></td> <td></td> </tr> <tr> <td>147169</td> <td></td> <td></td> <td></td> </tr> </tbody> </table>				ID	ID	ID	ID	147187	152302	* 152306	148031	147189	152303	* 152307	152310	146395				147169			
\varnothing " d_1	P	d_1	l_1	l_2	d_2	α																																																																																							
UNF	TPI	mm	mm	mm	mm	mm																																																																																							
7/16	20	11.11	100	22.0	8.0	6.2	* 4	10.00	ID																																																																																				
1/2	20	12.70	100	24.0	9.0	7.0	4	11.55	ID																																																																																				
9/16	18	14.28	100	24.0	11.0	9.0	4	13.05	ID																																																																																				
5/8	18	15.87	100	26.0	12.0	9.0	4	14.60	ID																																																																																				
ID	ID	ID	ID																																																																																										
147187	152302	* 152306	148031																																																																																										
147189	152303	* 152307	152310																																																																																										
146395																																																																																													
147169																																																																																													
<p>* SA420-4 = 3</p> <p>* TL420VS-4 = 3</p>																																																																																													

UNJF ASME B1.15 UNF ANSI B1.1

PM

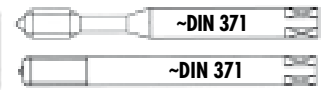

aero

SA320-4



SA390-3



SA320-4

SA390-3



NEW



3B UNJF

3B UNF(J)

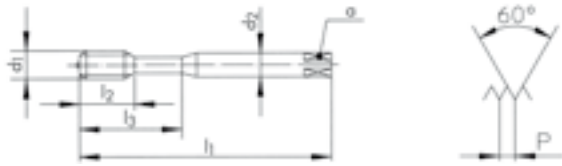

\varnothing d ₁ UNJF	P TPI	d ₁ mm	l ₁ mm	l ₂ mm	l ₃ mm	d ₂ mm	α mm			ID
10	32	4.82	70	15.0		6.0	4.9	3	4.15	174976
1/4	28	6.35	80	15.0	23	7.0	5.5	3	5.55	175993
5/16	24	7.93	90	18.0	29	8.0	6.2	3	7.00	175995
3/8	24	9.52	100	20.0	33	10.0	8.0	3	8.60	175997

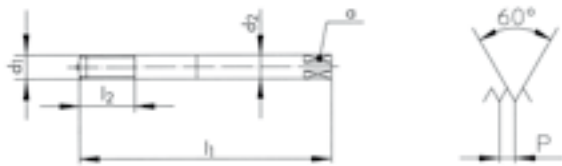

\varnothing d ₁ UNF	P TPI	d ₁ mm	l ₁ mm	l ₂ mm	d ₂ mm	α mm			ID
10	32	4.82	70	15.0	6.0	4.9	3	4.15	149687
1/4	28	6.35	80	20.0	7.0	5.5	3	5.55	149715
5/16	24	7.93	90	25.0	8.0	6.2	3	7.00	149728
3/8	24	9.52	100	30.0	10.0	8.0	3	8.60	149745

UNF

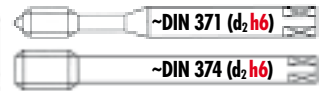

RTS

Rigid Tapping Synchro

RTS320VS-4

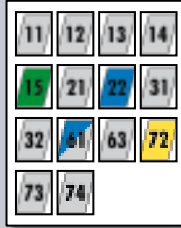

RTS420VS-4



RTS362VS-3



RTS462VS-3



RTS320VS-4

RTS420VS-4

RTS362VS-3

RTS462VS-3

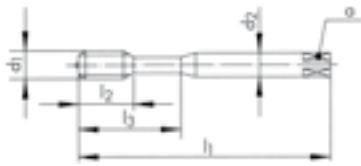

Ø" d ₁ UNF	P TPI	d ₁ mm	l ₁ mm	l ₂ mm	l ₃ mm	d ₂ h6 mm	α mm		
10	32	4.82	70	9.0	25	6.0	4.9	3	4.05
1/4	28	6.35	80	11.0	30	*6.0	*4.9	3	5.50
5/16	24	7.93	90	12.5	35	8.0	6.2	3	6.90
3/8	24	9.52	100	14.0	39	10.0	8.0	3	8.50
1/2	20	12.70	110	14.0		*10.0	*8.0	3	11.40

ID

ID

ID

ID

157409

157413

157410

157414

157411

157415

157412

157416

157417

157418

* Norme DC / * DC Norm / * Norma DC



sur demande
auf Anfrage
on request
su richiesta
sobre pedido

FS FPS FAS FORMING

FS380VS-5



VS

11	12	13	14
15	21	22	23
24	41	51	61
63	71	72	73

FPS381VS-3



VS

11	12	13	14	15
21	24	63		

FAS381VS-3



VS

12	13	14	15	21	22
23	24	41	51	61	63

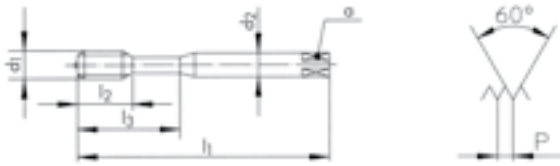

FS380VS-5

FPS381VS-3

FAS381VS-3



2BX

2BX

2BX

\varnothing d ₁ UNF	P TPI	d ₁ mm	l ₁ mm	l ₂ mm	l ₃ mm	d ₂ mm	α mm	$\frac{d_2}{P}$	Tol.
0	80	1.52	40	4.6		2.5	1.37		+ 0.02
10	32	4.82	70	15.0	25	6.0	4.9	4.45	+ 0.03
1/4	28	6.35	80	17.0	30	7.0	5.5	5.95	+ 0.05
5/16	24	7.93	90	20.0	35	8.0	6.2	7.45	+ 0.05

ID

ID

ID

161498

166718

166730

166719

166731

166720

166732











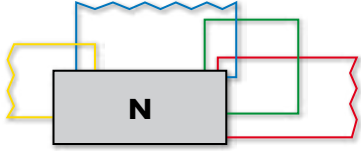
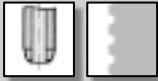

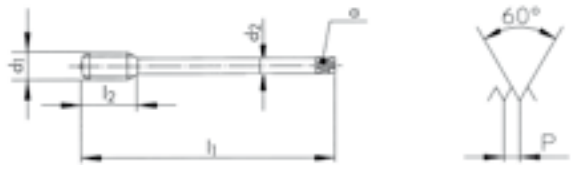
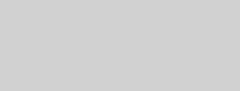

UNF ANSI B1.1

≤ Ø 2.8 > Ø 2.8

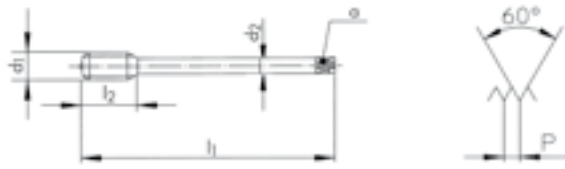
PM **HSS**



										N1110-1	N1110-3	N1110-S		
N1110-1														
N1110-3														
N1110-S														
Ø" d ₁ UNF	P TPI	d ₁ mm	l ₁ mm	l ₂ mm	l ₃ mm	d ₂ mm	a mm			ID	ID	ID		
0	80	1.52	40	7.0		2.50	2.10	3	1.20	102811	103010	111079		
1	72	1.85	40	8.0		2.50	2.10	3	1.50	102812	103011	111080		
4	48	2.84	48	11.0	18	3.15	2.50	3	2.35		* 103018			
8	36	4.16	53	13.0	21	4.50	3.55	3	3.50		* 103022			
10	32	4.82	58	16.0	25	5.00	4.00	3	4.05	102814	103013	111082		
12	28	5.48	62	17.0	26	5.60	4.50	3	4.60	* 102815	* 103014	* 111083		
1/4	28	6.35	66	19.0	30	6.30	5.00	3	5.50	102813	103012	111081		
5/16	24	7.93	72	22.0	35	8.00	6.30	3	6.90	102821	103020	111089		
3/8	24	9.52	80	24.0	39	10.00	8.00	3	8.50	102818	103017	111086		

										N1210-1	N1210-3	N1210-S					
										N1210-1			 				
N1210-3																	
N1210-S																	
																	
\varnothing d ₁ UNF	P TPI	d ₁ mm	l ₁ mm	l ₂ mm	d ₂ mm	a mm				ID	ID	ID					
7/16	20	11.11	85	22.0	8.0	6.3	3	9.80		103411	103626	111255					
1/2	20	12.70	89	24.0	9.0	7.1	3	11.40		103407	103622	111251					
5/8	18	15.87	102	32.0	12.5	10.0	3	14.50		103410	103625	111254					
3/4	16	19.05	112	33.0	14.0	11.2	4	17.50		103409	103624	111253					
7/8	14	22.22	115	32.0	16.0	12.5	4	20.40		103412	103627	111256					
1	12	25.40	130	45.0	18.0	14.0	4	23.30		103408	103623	111252					

UNF

										N1110-3	N1120-4	N1210-3	N1220-4
N1110-3													
N1120-4													
N1210-3													
N1220-4													
Ø" d ₁ UNEF	P TPI	d ₁ mm	l ₁ mm	l ₂ mm	l ₃ mm	d ₂ mm	a mm			ID	ID	ID	ID
12	32	5.48	62	17.0	26	5.6	4.5	3	4.70	103007	103118		
1/4	32	6.35	66	19.0	30	6.3	5.0	3	5.60	103006	103117		
5/16	32	7.93	72	22.0	35	8.0	6.3	3	7.20	103009	103120		
3/8	32	9.52	80	24.0	39	10.0	8.0	3	8.75	103008	103119		
7/16	28	11.11	85	22.0		8.0	6.3	3	10.25			103615	103754
1/2	28	12.70	89	24.0		9.0	7.1	3	11.85			103609	103749
9/16	24	14.28	95	24.0		11.2	9.0	3	13.20			103617	103756
5/8	24	15.87	102	32.0		12.5	10.0	3	14.80			103614	103753
11/16	24	17.46	104	26.0		14.0	11.2	4	16.40			103611	
3/4	20	19.05	112	33.0		14.0	11.2	4	17.80			103613	* 103752
7/8	20	22.22	115	32.0		16.0	12.5	4	21.00			103616	* 103755
1	20	25.40	120	30.0		18.0	14.0	4	24.10			103610	* 103750

















UNS, UN ANSI B1.1





















HSSE



















										N410-3	N460-3	N460V-3		
N410-3														
N460-3														
N460V-3														
$\varnothing'' d_1$	P	d_1	l_1	l_2	d_2	a				ID	ID	ID		
UNS	TPI	mm	mm	mm	mm	mm								
1/4	36	6.35	80	17.0	4.5	3.4	3	5.65	104899					
1/2	24	12.70	100	24.0	9.0	7.0	3	11.60	104900					
1	14	25.40	140	34.0	18.0	14.5	4	23.60	104898					
1	14	25.40	140	22.0	18.0	14.5	4	23.60		102437	142789			
$\varnothing'' d_1$	P	d_1	l_1	l_2	d_2	a				ID	ID			
UN	TPI	mm	mm	mm	mm	mm								
1 1/8	8	28.57	180	30.0	22.0	18.0	4	25.50		102415	142790			
1 1/4	8	31.75	180	30.0	22.0	18.0	4	28.70		102414	142520			
1 3/8	8	34.92	200	36.0	28.0	22.0	5	31.80		104896	142792			
1 1/2	8	38.10	200	40.0	32.0	24.0	5	35.00		102413	142793			
1 3/4	8	44.45	220	44.0	36.0	29.0	5	41.40			115198			
2	8	50.80	250	38.0	40.0	32.0	5	47.70			111622			











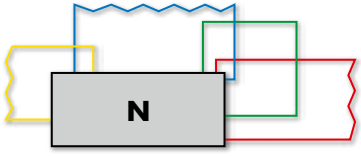





UNF, UNS, UN





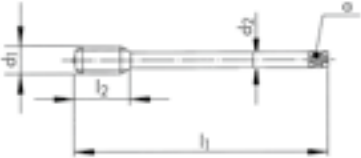





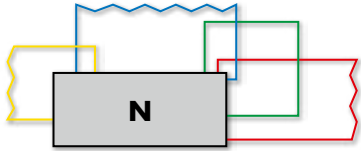





	N						
Характеристики Cechy charakterystyczne		 V	 TiN	 R40	 V	 R40	 TiN
Типы отверстий Typ otworu							
							
	N410-3	N420-4 N420V-4	N420TN-4	N460-3	N460V-3	N462V-3	N460TN-3
Длинный по DIN DIN 5156 DIN długi	156	157	157	158	158	158	158
Короткий по ISO DIN 5157 DIN krótki							
Левая резьба LH Gwint lewy DIN 5156	156						



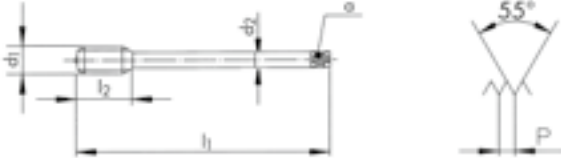



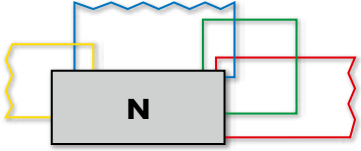

	H	GG	RTS	RTS	FPS	FAS	
Характеристики Cechy charakterystyczne		 NV	 VS	 E 1.5 x P VS	 VS	 VS	
							
Типы отверстий Typ otworu							
							
	H450-3	GG450NV-3	RTS462VS-3	RTS462VS-5	FPS481VS-3	FAS481VS-3	
Длинный по DIN DIN 5156 DIN długi	159	159					
Длинный по DIN ~DIN 376 DIN długi			161	161			
Длинный по DIN ~DIN 2189 DIN długi					162	162	

	N						
Характеристики Cechy charakterystyczne		 		 		  	
Типы отверстий Typ otworu							
				N1110-3	N1120-4	N5120	
Короткий по ISO ISO krótki	ISO 529			166	166		
W	ISO 529			166/167	166		
SV	ISO 529			167			
	N420-3	N410-3	D5800	N1210-3	N1220-4		
Длинный по DIN DIN długi	DIN 5156	164					
Длинный по DIN DIN długi	DC		164	165			
Короткий по ISO ISO krótki	ISO 529			166	166		
Rp	DIN 5156	164					
Rc	DC		164	165			
W	ISO 529			166	166		
SV	ISO 529/DC			167		167	

G (BSP),
Rp, Rc, W, SV

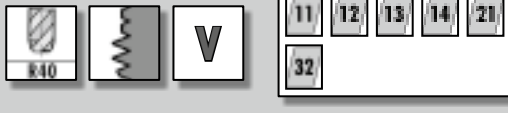
										N410-3		N410-3 LH							
										N410-3		N410-3 LH							
    										 		 		 					
 																			
$\varnothing^H d_1$ G	P TPI	d_1 mm	l_1 mm	l_2 mm	d_2 mm	α mm			ID	ID									
1/8	28	9.72	90	22.0	7.0	5.5	3	8.75	101855										
1/4	19	13.15	100	20.0	11.0	9.0	3	11.60	101853	101854									
3/8	19	16.66	100	20.0	12.0	9.0	4	15.20	101861	101862									
1/2	14	20.95	125	22.0	16.0	12.0	4	18.90	101851	101852									
3/4	14	26.44	140	28.0	20.0	16.0	4	24.40	101859	* 101860									
1	11	33.24	160	32.0	25.0	20.0	4	30.70	101857	* 101858									
1 1/4	11	41.91	170	32.0	32.0	24.0	5	39.30	101850										
1 1/2	11	47.80	190	32.0	36.0	29.0	5	45.20	101849										

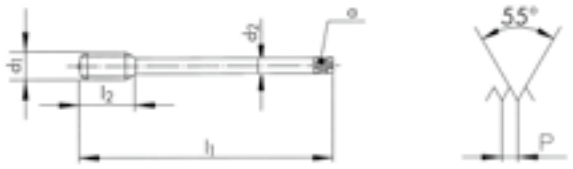
										N420-4	N420V-4	N420TN-4		
										N420-4  <table border="1" data-bbox="529 349 764 461"> <tr><td>61</td><td>63</td><td>71</td><td>72</td><td>73</td></tr> <tr><td>81</td><td></td><td></td><td></td><td></td></tr> </table>	61	63	71	72
61	63	71	72	73										
81														
N420V-4  V <table border="1" data-bbox="529 499 764 611"> <tr><td>11</td><td>12</td><td>13</td><td>14</td><td>21</td></tr> <tr><td>32</td><td></td><td></td><td></td><td></td></tr> </table>	11	12	13	14	21	32								
11	12	13	14	21										
32														
N420TN-4  TiN <table border="1" data-bbox="529 649 764 761"> <tr><td>11</td><td>12</td><td>13</td><td>14</td><td>21</td></tr> <tr><td>31</td><td>32</td><td>73</td><td>74</td><td></td></tr> </table>	11	12	13	14	21	31	32	73	74					
11	12	13	14	21										
31	32	73	74											
														
$\varnothing'' d_1$ G	P TPI	d_1 mm	l_1 mm	l_2 mm	d_2 mm	α mm				ID	ID	ID		
1/16	28	7.72	90	18.0	6.0	4.9	3	6.75		102045				
1/8	28	9.72	90	22.0	7.0	5.5	3	8.75		102048	102258	102236		
1/4	19	13.15	100	20.0	11.0	9.0	3	11.60		102047	102257	102235		
3/8	19	16.66	100	20.0	12.0	9.0	3	15.20		102053	102261	102238		
1/2	14	20.95	125	22.0	16.0	12.0	4	18.90		102046	102256	102234		
5/8	14	22.91	125	25.0	18.0	14.5	4	20.90		102054	144722			
3/4	14	26.44	140	28.0	20.0	16.0	4	24.40		102052	102260	102237		
1	11	33.24	160	32.0	25.0	20.0	4	30.70		102049	102259			
1 1/4	11	41.91	170	32.0	32.0	24.0	5	39.30		102043				
1 1/2	11	47.80	190	32.0	36.0	29.0	5	45.20		102042				
2	11	59.61	220	36.0	45.0	35.0	5	57.00		102051				
2 1/2	11	75.18	280	36.0	50.0	39.0	6	72.60		102050				

										N460-3	N460V-3	N460TN-3	N462V-3
													
													
													
													
													
\varnothing " d ₁ G	P TPI	d ₁ mm	l ₁ mm	l ₂ mm	d ₂ mm	α mm			ID	ID	ID	ID	
1/16	28	7.72	90	12.5	6.0	4.9	3	6.75	102341				
1/8	28	9.72	90	14.0	7.0	5.5	3	8.75	102344	102457	102444	143687	
1/4	19	13.15	100	14.0	11.0	9.0	3	11.60	102343	102456	102443	143600	
3/8	19	16.66	100	14.0	12.0	9.0	4	15.20	102348	102460	102446	143431	
1/2	14	20.95	125	20.0	16.0	12.0	4	18.90	102342	102455	102442	143921	
5/8	14	22.91	125	20.0	18.0	14.5	4	20.90	102349	143711			
3/4	14	26.44	140	22.0	20.0	16.0	4	24.40	102347	102459	102445	143688	
1	11	33.24	160	26.0	25.0	20.0	4	30.70	102345	102458			
1 1/4	11	41.91	170	30.0	32.0	24.0	5	39.30	102340	111608			
1 1/2	11	47.80	190	35.0	36.0	29.0	5	45.20	102339	111609			
2	11	59.61	220	41.0	45.0	35.0	6	57.00	102346	111503			

G DIN ISO 228 (BSP)

≤ Ø 25.4 > Ø 25.4

PM

HSSE

HSSE

H/GG

H/GG

W

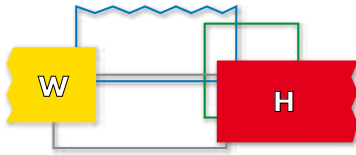

W460-5

W460DL-5

H450-3

GG450NV-3

W460-5



W460DL-5



H450-3



GG450NV-3



NEW

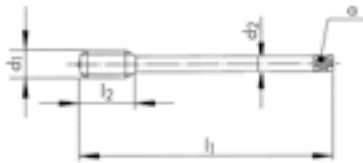

Ø" d ₁ G	P TPI	d ₁ mm	l ₁ mm	l ₂ mm	d ₂ mm	a mm		
1/8	28	9.72	90	14.0	7.0	5.5	3	8.75
1/4	19	13.15	100	14.0	11.0	9.0	*4	11.60
3/8	19	16.66	100	14.0	12.0	9.0	4	15.20
1/2	14	20.95	125	20.0	16.0	12.0	4	18.90
3/4	14	26.44	140	22.0	20.0	16.0	4	24.40
1	11	33.24	160	26.0	25.0	20.0	4	30.70

* W460-5 = 3

ID

ID

ID

119350

176728

101298

119300

176729

101297

119682

176730

101301

119199

176731

101296

101300

101299

Ø" d ₁ G	P TPI	d ₁ mm	l ₁ mm	l ₂ mm	d ₂ mm	a mm		
1/8	28	9.72	90	22.0	7.0	5.5	4	8.75
1/4	19	13.15	100	20.0	11.0	9.0	4	11.60
3/8	19	16.66	100	20.0	12.0	9.0	4	15.20
1/2	14	20.95	125	22.0	16.0	12.0	4	18.90
3/4	14	26.44	140	28.0	20.0	16.0	4	24.40
1	11	33.24	160	32.0	25.0	20.0	4	30.70

ID

102309

102308

102312

102307

102311

102310

G DIN ISO 228 (BSP)

< Ø 25.4 > Ø 25.4

PM
Z420

HSSE
Z420

HSSE
Z460

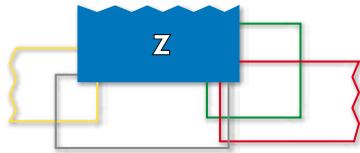

Z420V-4		V	21 22 23 41 42 51
Z420VS-4		VS	21 22 23 24 51 61
Z460V-3		V	22 23 51

Z420V-4	Z420VS-4	Z460V-3	
----------------	-----------------	----------------	--

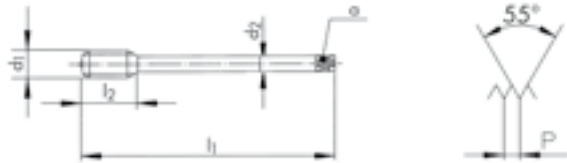

Ø" d ₁ G	P TPI	d ₁ mm	l ₁ mm	l ₂ mm	d ₂ mm	α mm		
1/8	28	9.72	90	22.0	7.0	5.5	3	8.75
1/4	19	13.15	100	20.0	11.0	9.0	3	11.60
3/8	19	16.66	100	20.0	12.0	9.0	3	15.20
1/2	14	20.95	125	22.0	16.0	12.0	4	18.90
3/4	14	26.44	140	28.0	20.0	16.0	4	24.40
1	11	33.24	160	32.0	25.0	20.0	4	30.70

ID	ID
142794	142800
142795	119303
142796	142802
142797	142803
142798	
142799	

Ø" d ₁ G	P TPI	d ₁ mm	l ₁ mm	l ₂ mm	d ₂ mm	α mm		
1/8	28	9.72	90	14.0	7.0	5.5	3	8.75
1/4	19	13.15	100	14.0	11.0	9.0	3	11.60
3/8	19	16.66	100	14.0	12.0	9.0	4	15.20
1/2	14	20.95	125	20.0	16.0	12.0	4	18.90
3/4	14	26.44	140	22.0	20.0	16.0	4	24.40
1	11	33.24	160	26.0	25.0	20.0	4	30.70

ID
104726
104725
104728
104724
104727
105142



Uniquement pour taraudage synchrone
Nur für Synchrobearbeitung
Only for rigid tapping
Solo per maschiatura sincrona
Solo para roscado sincronizado

PM

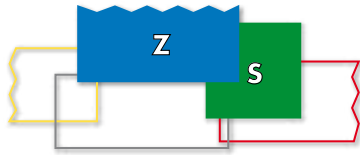

Z470VS-3

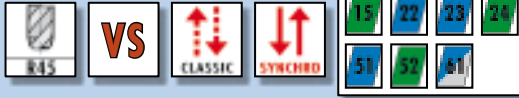

RTS

Rigid Tapping Synchro

RTS462VS-3

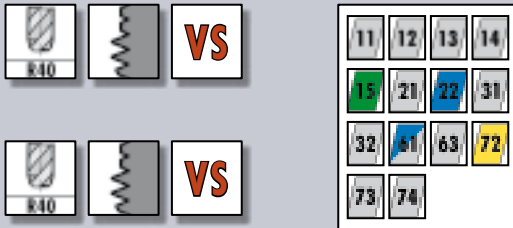

RTS462VS-5

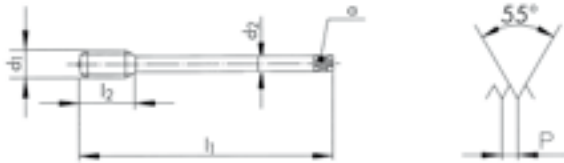

Z470VS-3



RTS462VS-3



RTS462VS-5



$\varnothing'' d_1$ G	P TPI	d_1 mm	l_1 mm	l_2 mm	$d_2 h6$ mm	α mm			ID
1/8	28	9.72	100	14.0	*8.0	*6.2	3	8.75	165198
1/4	19	13.15	110	14.0	*12.0	*9.0	4	11.60	165199
3/8	19	16.66	110	18.0	12.0	9.0	4	15.20	165200
1/2	14	20.95	125	20.0	16.0	12.0	4	18.90	165201

* Norme DC / * DC Norm / * Norma DC







$\varnothing'' d_1$ G	P TPI	d_1 mm	l_1 mm	l_2 mm	$d_2 h6$ mm	α mm			ID	ID
1/8	28	9.72	100	14.0	*8.0	*6.2	3	8.75	151861	170629
1/4	19	13.15	110	14.0	*12.0	*9.0	3	11.60	151868	170631
3/8	19	16.66	110	18.0	12.0	9.0	4	15.20	151872	170633
1/2	14	20.95	125	20.0	16.0	12.0	4	18.90	150685	170635

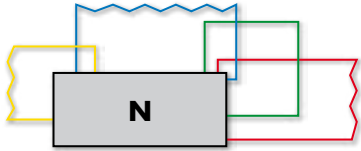
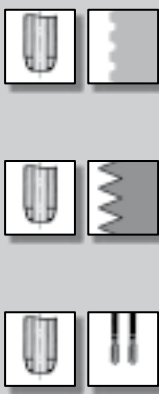
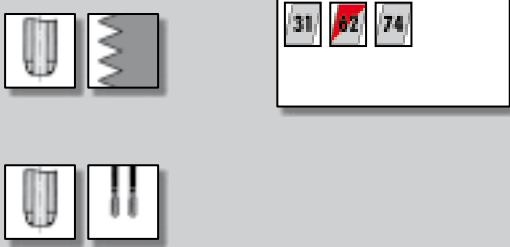

* Norme DC / * DC Norm / * Norma DC

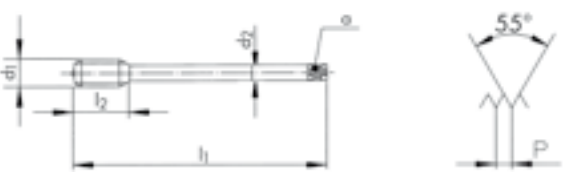

sur demande
auf Anfrage
on request
su richiesta
sobre pedido

FPS FAS		FORMING		FPS481VS-3	FAS481VS-3												
FPS481VS-3		VS	<table border="1"> <tr> <td>11</td> <td>12</td> <td>13</td> <td>14</td> <td>15</td> </tr> <tr> <td>21</td> <td>24</td> <td>63</td> <td></td> <td></td> </tr> </table>	11	12	13	14	15	21	24	63						
11	12	13	14	15													
21	24	63															
FAS481VS-3		VS	<table border="1"> <tr> <td>12</td> <td>13</td> <td>14</td> <td>15</td> <td>21</td> <td>22</td> </tr> <tr> <td>23</td> <td>24</td> <td>41</td> <td>51</td> <td>61</td> <td>63</td> </tr> </table>	12	13	14	15	21	22	23	24	41	51	61	63		
12	13	14	15	21	22												
23	24	41	51	61	63												
\varnothing d ₁ G	P TPI	d ₁ mm	l ₁ mm	l ₂ mm	d ₂ mm	α mm		Tol.	ID	ID							
1/8	28	9.72	90	22.0	7.0	5.5	9.25	+ 0.05	166721	166733							
1/4	19	13.15	100	20.0	11.0	9.0	12.50	+ 0.05	166722	166734							
3/8	19	16.66	100	20.0	12.0	9.0	16.00	+ 0.05	166723	166735							
1/2	14	20.95	125	22.0	16.0	12.0	20.00	+ 0.05	166724	166736							

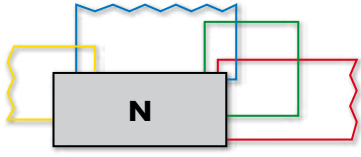
										N210-1	N210-3	N210-S
												
												
												
\varnothing d ₁ G	P TPI	d ₁ mm	l ₁ mm	l ₂ mm	d ₂ mm	a mm				ID	ID	ID
1/16	28	7.72	63	18.0	6.0	4.9	3	6.75			101418	
1/8	28	9.72	63	22.0	7.0	5.5	3	8.75	101404	101421	119386	
1/4	19	13.15	70	20.0	11.0	9.0	3	11.60	101403	101420	119336	
3/8	19	16.66	70	20.0	12.0	9.0	4	15.20	101409	101427	110938	
1/2	14	20.95	80	22.0	16.0	12.0	4	18.90	101402	101419	119264	
5/8	14	22.91	80	25.0	18.0	14.5	4	20.90	101411	105140	110940	
3/4	14	26.44	90	28.0	20.0	16.0	4	24.40	101408	101426	110937	
7/8	14	30.20	90	28.0	22.0	18.0	4	28.20	* 101412	* 101429		
1	11	33.24	100	32.0	25.0	20.0	4	30.70	101405	101422	110933	
1 1/8	11	37.89	125	32.0	28.0	22.0	4	35.30		101415		
1 1/4	11	41.91	125	32.0	32.0	24.0	5	39.30	101400	101414	111425	
1 3/8	11	44.32	125	32.0	36.0	29.0	5	41.80		* 101417		
1 1/2	11	47.80	140	32.0	36.0	29.0	5	45.20	101399	101413	110934	
1 3/4	11	53.74	140	36.0	40.0	32.0	5	51.20		* 101416		
2	11	59.61	160	36.0	45.0	35.0	5	57.00	101407	101425	110935	
2 1/2	11	75.18	160	36.0	50.0	39.0	6	72.60		101423		
3	11	87.88	160	40.0	50.0	39.0	6	85.30		* 101428		

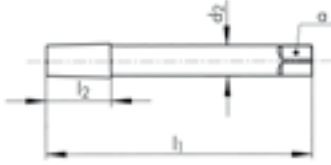
					D5800			
D5800 								
								
\varnothing'' Rc	l_1 mm	l_2 mm	d_2 mm	a mm	ID			
1/16	70	17.0	6.0	4.9	118701			
1/8	70	17.0	8.0	6.2	110531			
1/4	80	27.0	10.0	8.0	110530			
3/8	85	27.0	12.0	9.0	110535			
1/2	95	35.0	16.0	12.0	110529			
3/4	105	35.0	20.0	16.0	110534			
1	130	43.0	25.0	20.0	110532			

Диаметр отверстия под коническую трубную резьбу по DIN EN 10226
Średnice otworów pod gwinty stożkowe rurowe wg DIN EN 10226

Отверстие с параллельными стенками
Повышенный износ, не рекомендуется

Отwór walcowy
Zwiększone zużycie gwintownika, nie zalecane

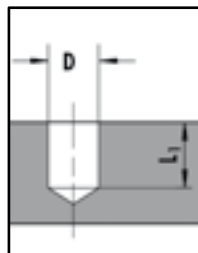

Коническое отверстие 1:16
Предварительное отв. D_2 и развертывание до D_3

Отwór stożkowy 1:16
Nawierć na $\varnothing D_2$ i rozwiерć stożkowo na $\varnothing D_3$

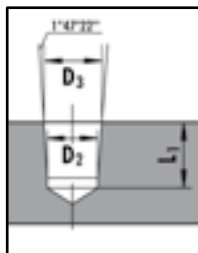

Коническое отверстие
Заход метчика на глубину $L_2 = \text{номинальный диаметр}$

Отwór gwintowany
Gwintuj otwór na głębokość $L_2 = \varnothing \text{ nominalna}$

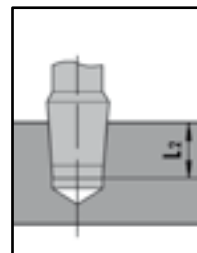

\varnothing'' Rc	L_1 min. mm	D_1 mm	D_2 mm	D_3 mm	L_2 mm
1/16	11.90	6.20	6.10	6.56	10.60
1/8	11.90	8.20	8.10	8.57	10.60
1/4	17.70	11.00	10.75	11.45	15.70
3/8	18.10	14.50	14.25	14.95	16.10
1/2	24.00	18.00	17.75	18.63	21.40
3/4	25.30	23.50	23.00	24.12	21.50
1	30.60	29.50	29.00	30.29	26.30

W BS 84 (BSW)

HSS

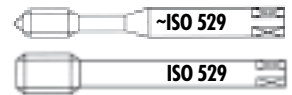















										N1110-3	N1210-3	N1120-4	N1220-4	
N1110-3														
N1210-3														
N1120-4														
N1220-4														
\varnothing W	d_1	P	d_1	l_1	l_2	l_3	d_2	a			ID	ID	ID	ID
1/8	40	3.17	48	11.0	18	3.15	2.50	3	2.50		103025		103126	
5/32	32	3.96	53	13.0	21	4.00	3.15	3	3.10		103031		103130	
3/16	24	4.76	58	16.0	25	5.00	4.00	3	3.60		103026		103127	
1/4	20	6.35	66	19.0	30	6.30	5.00	3	4.90		103024		103125	
5/16	18	7.93	72	22.0	35	8.00	6.30	3	6.40		103030		103129	
3/8	16	9.52	80	24.0	39	10.00	8.00	3	7.70		103028		103128	
7/16	14	11.11	85	22.0		8.00	6.30	3	9.10			103642		103771
1/2	12	12.70	89	24.0		9.00	7.10	3	10.30			103634		103767
9/16	12	14.28	95	24.0		11.20	9.00	3	11.90			* 103644		
5/8	11	15.87	102	32.0		12.50	10.00	3	13.30			103641		103770
3/4	10	19.05	112	33.0		14.00	11.20	3	16.20			103640		103769
1	8	25.40	130	45.0		18.00	14.00	4	21.90			* 103635		

		N1110-3		N1210-3		N5120			
N1110-3									
N1210-3									
N5120									
$\varnothing d_1$ W		P TPI/mm		l_1 mm		l_2 mm		l_3 mm	
		d_2 mm		a mm					
5		36 TPI/1"		B6		58		16.0	
6.82		0.625		B8		66		19.0	
						25		5.0	
						7.1		5.6	
								3	
								4.20*	
								6.15*	
								103029	
								111143	
$\varnothing d_1$ SV		P mm		l_1 mm		l_2 mm		l_3 mm	
				d_2 mm		a mm			
10		0.833		W10		80		24.0	
12		1.250		W12		89		24.0	
15		1.250		W15		90		23.0	
20		1.666		W20		112		37.0	
25		1.693		W25		120		30.0	
						18.0		14.0	
								14.0	
								3	
								8.80*	
								10.50*	
								13.50*	
								17.80*	
								22.70*	
								130429	
								103591	
								103592	
								103593	
								103594	
*Tol.		$\begin{matrix} +0.1 \text{ mm} \\ 0 \end{matrix}$							
$\varnothing d_1$ W		P mm		d_2 mm		l_1 mm			
6.82		0.625		B6		25.0		9.0	
								4	
								6.77	
								130215	

W, SV

NPT, NPTF

Указатель – Машинные метчики, NPT ANSI B1.20.1 и NPTF B1.20.3
 Skorowidz – Gwintowniki maszynowe, NPT ANSI B1.20.1 i NPTF B1.20.3

		N						
Характеристики Cechy charakterystyczne		 	  					
								
Типы отверстий Typ otworu								
								
	N410-3	N410V-3	N411V-3	D5800				
NPT Длинный по DIN NPT DIN długi DC	170	170	170	171				
NPTF Длинный по DIN NPTF DIN długi DC	170			171				

	N						
Характеристики Cechy charakterystyczne							
Типы отверстий Typ otworu							
	N420-3	N410-1	N410-2	N410-3	N410-S	N410-8	
PG Длинный по DIN PG DIN długi DIN 40433	172						
TR Длинный по DIN TR DIN długi DC		173	173	173	173	172	
Класс точности Tolerancja TR 7H				173	173	172	

NPT, NPTF
PG, TR

NPT, NPTF

ANSI B1.20.1, ANSI B1.20.3

HSSE



							N410-3	N410V-3	N411V-3	N410-3																																																																																																																									
N410-3																																																																																																																																			
N410V-3																																																																																																																																			
N411V-3																																																																																																																																			
N410-3																																																																																																																																			
<table border="1"> <thead> <tr> <th>Ø" d₁ NPT, NPTF</th> <th>P TPI</th> <th>l₁ mm</th> <th>l₂ mm</th> <th>d₂ mm</th> <th>a mm</th> <th></th> </tr> </thead> <tbody> <tr><td>1/16</td><td>27</td><td>71</td><td>13.0</td><td>7.0</td><td>5.5</td><td>3</td></tr> <tr><td>1/8</td><td>27</td><td>71</td><td>13.0</td><td>8.0</td><td>6.2</td><td>5</td></tr> <tr><td>1/4</td><td>18</td><td>80</td><td>20.0</td><td>11.0</td><td>9.0</td><td>5</td></tr> <tr><td>3/8</td><td>18</td><td>90</td><td>20.0</td><td>12.0</td><td>9.0</td><td>5</td></tr> <tr><td>1/2</td><td>14</td><td>100</td><td>26.0</td><td>16.0</td><td>12.0</td><td>5</td></tr> <tr><td>3/4</td><td>14</td><td>110</td><td>26.0</td><td>20.0</td><td>16.0</td><td>5</td></tr> <tr><td>1</td><td>11.5</td><td>125</td><td>32.0</td><td>25.0</td><td>20.0</td><td>5</td></tr> <tr><td>1 1/4</td><td>11.5</td><td>125</td><td>32.0</td><td>32.0</td><td>24.0</td><td>5</td></tr> <tr><td>1 1/2</td><td>11.5</td><td>140</td><td>32.0</td><td>36.0</td><td>29.0</td><td>5</td></tr> <tr><td>2</td><td>11.5</td><td>160</td><td>32.0</td><td>36.0</td><td>29.0</td><td>7</td></tr> </tbody> </table>							Ø" d ₁ NPT, NPTF	P TPI	l ₁ mm	l ₂ mm	d ₂ mm	a mm		1/16	27	71	13.0	7.0	5.5	3	1/8	27	71	13.0	8.0	6.2	5	1/4	18	80	20.0	11.0	9.0	5	3/8	18	90	20.0	12.0	9.0	5	1/2	14	100	26.0	16.0	12.0	5	3/4	14	110	26.0	20.0	16.0	5	1	11.5	125	32.0	25.0	20.0	5	1 1/4	11.5	125	32.0	32.0	24.0	5	1 1/2	11.5	140	32.0	36.0	29.0	5	2	11.5	160	32.0	36.0	29.0	7	<table border="1"> <thead> <tr> <th>ID</th> <th>ID</th> <th>ID</th> <th>ID</th> </tr> </thead> <tbody> <tr><td>101961</td><td>102021</td><td>102031</td><td>101971</td></tr> <tr><td>101964</td><td>102024</td><td>102034</td><td>101974</td></tr> <tr><td>101963</td><td>102023</td><td>102033</td><td>101973</td></tr> <tr><td>101968</td><td>102028</td><td>102038</td><td>101978</td></tr> <tr><td>101962</td><td>102022</td><td>102032</td><td>101972</td></tr> <tr><td>101967</td><td>102027</td><td>102037</td><td>101977</td></tr> <tr><td>101965</td><td>102025</td><td>102035</td><td>101975</td></tr> <tr><td>101960</td><td>102020</td><td></td><td></td></tr> <tr><td>101959</td><td>102019</td><td></td><td></td></tr> <tr><td>101966</td><td>102026</td><td></td><td></td></tr> </tbody> </table>				ID	ID	ID	ID	101961	102021	102031	101971	101964	102024	102034	101974	101963	102023	102033	101973	101968	102028	102038	101978	101962	102022	102032	101972	101967	102027	102037	101977	101965	102025	102035	101975	101960	102020			101959	102019			101966	102026		
Ø" d ₁ NPT, NPTF	P TPI	l ₁ mm	l ₂ mm	d ₂ mm	a mm																																																																																																																														
1/16	27	71	13.0	7.0	5.5	3																																																																																																																													
1/8	27	71	13.0	8.0	6.2	5																																																																																																																													
1/4	18	80	20.0	11.0	9.0	5																																																																																																																													
3/8	18	90	20.0	12.0	9.0	5																																																																																																																													
1/2	14	100	26.0	16.0	12.0	5																																																																																																																													
3/4	14	110	26.0	20.0	16.0	5																																																																																																																													
1	11.5	125	32.0	25.0	20.0	5																																																																																																																													
1 1/4	11.5	125	32.0	32.0	24.0	5																																																																																																																													
1 1/2	11.5	140	32.0	36.0	29.0	5																																																																																																																													
2	11.5	160	32.0	36.0	29.0	7																																																																																																																													
ID	ID	ID	ID																																																																																																																																
101961	102021	102031	101971																																																																																																																																
101964	102024	102034	101974																																																																																																																																
101963	102023	102033	101973																																																																																																																																
101968	102028	102038	101978																																																																																																																																
101962	102022	102032	101972																																																																																																																																
101967	102027	102037	101977																																																																																																																																
101965	102025	102035	101975																																																																																																																																
101960	102020																																																																																																																																		
101959	102019																																																																																																																																		
101966	102026																																																																																																																																		

		Vc (m/min) Ø d1			
NPT, NPTF 1/16" - 1/4"		3/8" - 1/2"	3/4" - 1"	1.1/4" - 2"	
	6	5	4	3	
	5	4	3	2	
	10	8	7	5	
	18	15	13	10	

NPT, NPTF

ANSI B1.20.1, ANSI B1.20.3

HSSE

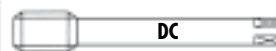

					D5800			
D5800								
\varnothing'' NPT, NPTF	l_1 mm	l_2 mm	d_2 mm	a mm	ID			
1/16	70	17.0	6.0	4.9	118701			
1/8	70	17.0	8.0	6.2	110531			
1/4	80	27.0	10.0	8.0	110530			
3/8	85	27.0	12.0	9.0	110535			
1/2	95	35.0	16.0	12.0	110529			
3/4	105	35.0	20.0	16.0	110534			
1	130	43.0	25.0	20.0	110532			

Диаметр отверстия под резьбы NPT и NPTF Średnice otworów pod gwinty NPT oraz NPTF

Отверстие с параллельными стенками
Повышенный износ, не рекомендуется

Отwór walcowy
Zwiększone zużycie gwintownika, nie zalecane

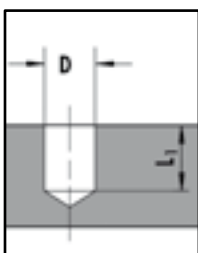

Коническое отверстие 1:16
Предварительное отв. D_2 и развёртывание до D_3

Отwór stożkowy 1:16
Nawierć na $\varnothing D_2$ i rozwić stożkowo na $\varnothing D_3$

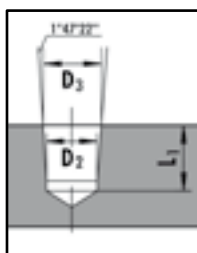

Коническое отверстие
Заход метчика на глубину L_3 = номинальный диаметр

Отwór gwintowany
Gwintuj otwór na głębokość L_3 = \varnothing nominalna

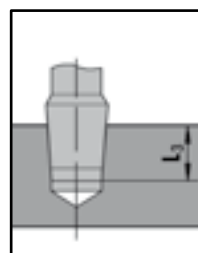

*Рекомендуется конич. развёртывание до D_3

*Zalecane jest rozwiercanie stożkowe do górnego limitu D_3

\varnothing'' NPT, NPTF	D mm	L_1 mm	D_2 mm	NPT $D_3(+0.05)$ mm	NPTF $D_3(+0.05)$ mm	L_3 mm
1/16	6.15	12.00	6.00	6.39	6.41	10.20
1/8	8.50	12.00	8.30	8.74	8.76	10.30
1/4	11.00	17.50	10.80	11.36	11.40	15.10
3/8	14.50	17.50	14.20	14.80	14.84	15.30
1/2	17.90	23.00	17.50	18.32	18.33	20.00
3/4	23.20	23.00	22.80	23.67	23.68	20.50
1	29.00	28.00	28.60	29.69	29.72	24.60

NPT, NPTF

PG DIN 40430 TR ISO 2901-2904, DIN 103

HSSE

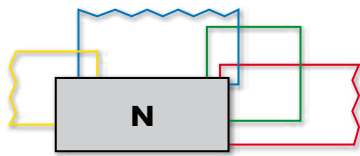
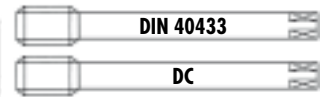

N420-3

N410-8

N420-3





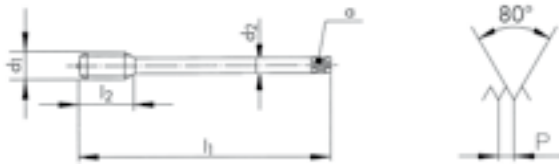



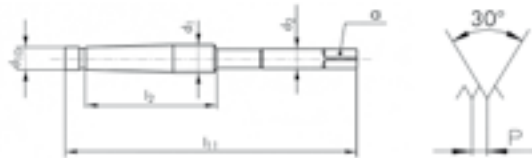

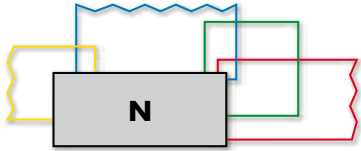

N410-8

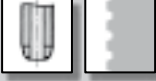



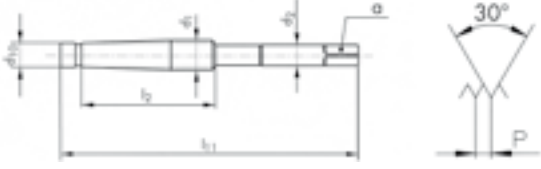

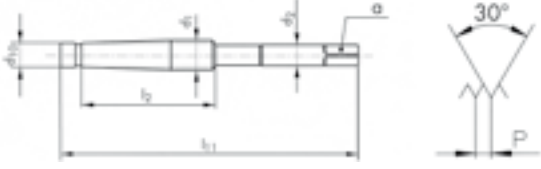



















$\varnothing d_1$ PG	P TPI	d_1 mm	l_1 mm	l_2 mm	d_2 mm	a mm			ID
7	20	12.50	100	24.0	9.0	7.0	3	11.30	104901
9	18	15.20	100	26.0	12.0	9.0	3	13.90	104902
11	18	18.60	110	26.0	14.0	11.0	4	17.30	104903
13.5	18	20.40	125	28.0	16.0	12.0	4	19.10	104904
16	18	22.50	125	28.0	18.0	14.5	4	21.20	104905
21	16	28.30	150	36.0	22.0	18.0	4	26.80	104906
29	16	37.00	170	38.0	28.0	22.0	4	35.50	104907
36	16	47.00	190	38.0	36.0	29.0	5	45.50	104908





















































































































$\varnothing d_1$ TR	P mm	l_{11} mm	l_2 mm	d_{10} mm	d_2 mm	a mm			ID
10	2.00	100	45.0	8.20	7.0	5.5	3	8.20	102008
12	3.00	140	75.0	9.25	8.0	6.2	3	9.25	102009
14	3.00	150	75.0	11.25	10.0	8.0	3	11.25	102010
16	4.00	180	100.0	12.25	11.0	9.0	3	12.25	102011
18	4.00	180	100.0	14.25	12.0	9.0	3	14.25	102012
20	4.00	190	100.0	16.25	14.0	11.0	3	16.25	102013
22	5.00	220	110.0	17.25	16.0	12.0	4	17.25	111616
24	5.00	220	110.0	19.25	18.0	14.5	4	19.25	102015

									N410-1	N410-2	N410-3	N410-S
												
N410-1												
N410-2												
N410-3												
N410-S												
									7H		7H	
$\varnothing d_1$ TR	P mm	l_{11} mm	l_2 mm	d_{10} mm	d_2 mm	a mm			ID	ID	ID	ID
10	2.00	85	30.0	8.20	7.0	5.5	3	8.20	* 101827	* 101838	* 101979	* 110972
12	3.00	115	45.0	9.25	8.0	6.2	3	9.25	* 101828	* 101839	* 101980	* 110973
16	4.00	165	65.0	12.25	11.0	9.0	3	12.25	* 101830	* 101841	* 101982	* 110975
20	4.00	175	65.0	16.25	14.0	11.0	3	16.25	* 101832	* 101843	* 101984	* 110977

	N				Z	S	
Характеристики Cechy charakterystyczne 		 V	 R40	 R40	 R45	 VS	 VS
							
Типы отверстий Typ otworu 							
	N320-4	N320V-4	N360-3	N360V-3	Z370VS-3	S320VS-4	S360VS-3
Длинный по DIN DIN długi ~DIN 40435	176	176	177	177			
Длинный по DIN DIN długi ~DIN 2184-1	180/183		180/183		181/184	184	184
Резьба Gwint EG M	176	176	177	177			
Резьба Gwint EG UNC	180		180		181		
Резьба Gwint EG UNF	183		183		184	184	184
	N420-4	N420V-4	N460-3	N460V-3			
Длинный по DIN DIN długi ~DIN 40435	176	176	177	177			
Длинный по DIN DIN długi ~DIN 2184-1	180/183		180/183				
Резьба Gwint EG M	176	176	177	177			
Резьба Gwint EG UNC	180		180				
Резьба Gwint EG UNF	183		183				

EG

Указатель – Машинные метчики для резьбовых вставок, EG M, EG UNC, EG UNF
Skorowidz – Gwintowniki maszynowe pod wkładki HELICOIL, EG M, EG UNC, EG UNF

SA			TL	
				
				
				
				
				
				
				
				
				
				
				
				
				
				
				
				
				
				
				
				
				
				
				
</				



≤ Ø 2.8 > Ø 2.8

PM

HSSE

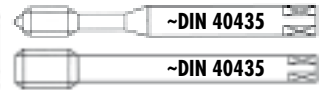

										N320-4	N320V-4	N420-4	N420V-4
N320-4			61	63	71	72	73	81					
N320V-4		V	11	12	13	14	21	32					
N420-4			61	63	71	72	73	81					
N420V-4		V	11	12	13	14	21	32					
										B 4 x P	B 4 x P	B 4 x P	B 4 x P
										6H mod	6H mod	6H mod	6H mod
Ø d ₁ EG M	P mm	d ₁ mm	l ₁ mm	l ₂ mm	l ₃ mm	d ₂ mm	a mm			ID	ID	ID	ID
2	0.40	2.520	50	10.0		2.8	2.1	3	2.10	101537	118788		
2.5	0.45	3.084	56	12.0	18	3.5	2.7	3	2.65	101538			
3	0.50	3.650	56	13.0	20	4.0	3.0	3	3.15	101539	142804		
4	0.70	4.910	70	15.0	25	6.0	4.9	3	4.20	101540	142805		
5	0.80	6.040	80	17.0	30	6.0	4.9	3	5.25	101541	142806		
6	1.00	7.300	80	17.0	30	7.0	5.5	3	6.30	101542	142807		
8	1.25	9.624	100	22.0	39	10.0	8.0	3	8.40	101543	142808		
10	1.50	11.948	100	24.0		9.0	7.0	3	10.40			102252	142809
12	1.75	14.274	110	28.0		11.0	9.0	3	12.50			102253	142810
14	2.00	16.598	110	30.0		12.0	9.0	3	14.60				* 142811
16	2.00	18.598	125	33.0		14.0	11.0	3	16.60			102255	142812



≤ Ø 2.8 > Ø 2.8

PM **HSSE**

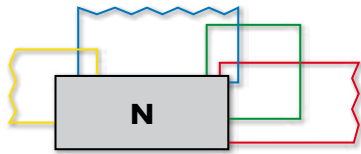
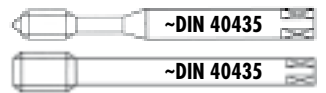

N360-3



N360V-3



N460-3



N460V-3



N360-3

N360V-3

N460-3

N460V-3

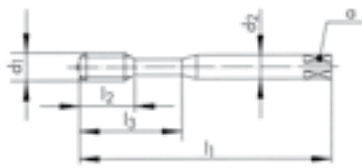

Ø d ₁ EG M	P mm	d ₁ mm	l ₁ mm	l ₂ mm	l ₃ mm	d ₂ mm	α mm		
2	0.40	2.520	50	9.0		2.8	2.1	2	2.10
2.5	0.45	3.084	56	5.5	18	3.5	2.7	3	2.65
3	0.50	3.650	56	6.5	20	4.0	3.0	3	3.15
4	0.70	4.910	70	9.0	25	6.0	4.9	3	4.20
5	0.80	6.040	80	11.0	30	6.0	4.9	3	5.25
6	1.00	7.300	80	11.0	30	7.0	5.5	3	6.30
8	1.25	9.624	100	14.0	39	10.0	8.0	3	8.40
10	1.50	11.948	100	14.0		9.0	7.0	3	10.40
12	1.75	14.274	110	14.0		11.0	9.0	3	12.50
14	2.00	16.598	110	18.0		12.0	9.0	3	14.60
16	2.00	18.598	125	21.0		14.0	11.0	3	16.60

ID

ID

ID

ID

101599

101600

101601

142813

101602

142814

101603

142815

101604

142816

101605

142817

102335

142818

102336

142819

102337

142820

102338

142821



aero

										SA320-4	SA350-3	TL320VS-4	TL351VS-3																																																												
<div style="display: flex; justify-content: space-between;"> <div style="width: 45%;"> <p>SA320-4 52 53</p> <p>SA350-3 52 53</p> <p>TL320VS-4 VS 41 42</p> <p>TL351VS-3 VS 41 42</p> </div> <div style="width: 50%; text-align: center;"> </div> </div>																																																																									
										6H mod	6H mod	6H mod	6H mod																																																												
<table border="1" style="width: 100%; border-collapse: collapse;"> <thead> <tr> <th>$\varnothing d_1$ EG M</th> <th>P mm</th> <th>d_2 mm</th> <th>l_1 mm</th> <th>l_2 mm</th> <th>l_3 mm</th> <th>d_2 mm</th> <th>α mm</th> <th></th> <th></th> </tr> </thead> <tbody> <tr> <td>3</td> <td>0.50</td> <td>3.650</td> <td>56</td> <td>13.0</td> <td></td> <td>4.0</td> <td>3.0</td> <td>3</td> <td>3.15</td> </tr> <tr> <td>4</td> <td>0.70</td> <td>4.910</td> <td>70</td> <td>15.0</td> <td></td> <td>6.0</td> <td>4.9</td> <td>3</td> <td>4.20</td> </tr> <tr> <td>5</td> <td>0.80</td> <td>6.040</td> <td>80</td> <td>15.0</td> <td>23</td> <td>6.0</td> <td>4.9</td> <td>3</td> <td>5.25</td> </tr> <tr> <td>6</td> <td>1.00</td> <td>7.300</td> <td>80</td> <td>15.0</td> <td>23</td> <td>7.0</td> <td>5.5</td> <td>3</td> <td>6.30</td> </tr> <tr> <td>8</td> <td>1.25</td> <td>9.624</td> <td>100</td> <td>20.0</td> <td>33</td> <td>10.0</td> <td>8.0</td> <td>3</td> <td>8.40</td> </tr> </tbody> </table>										$\varnothing d_1$ EG M	P mm	d_2 mm	l_1 mm	l_2 mm	l_3 mm	d_2 mm	α mm			3	0.50	3.650	56	13.0		4.0	3.0	3	3.15	4	0.70	4.910	70	15.0		6.0	4.9	3	4.20	5	0.80	6.040	80	15.0	23	6.0	4.9	3	5.25	6	1.00	7.300	80	15.0	23	7.0	5.5	3	6.30	8	1.25	9.624	100	20.0	33	10.0	8.0	3	8.40	ID	ID	ID	ID
$\varnothing d_1$ EG M	P mm	d_2 mm	l_1 mm	l_2 mm	l_3 mm	d_2 mm	α mm																																																																		
3	0.50	3.650	56	13.0		4.0	3.0	3	3.15																																																																
4	0.70	4.910	70	15.0		6.0	4.9	3	4.20																																																																
5	0.80	6.040	80	15.0	23	6.0	4.9	3	5.25																																																																
6	1.00	7.300	80	15.0	23	7.0	5.5	3	6.30																																																																
8	1.25	9.624	100	20.0	33	10.0	8.0	3	8.40																																																																
										147676	147682	* 152001	150478																																																												
										147678	147684	* 152002	152003																																																												
										147680	147686	*	150184																																																												
										147688	147692	* 152004	152005																																																												
										149354	149356	* 152088	152089																																																												



aero

SA390-3

SA390-3

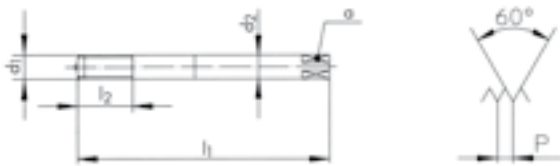

$\varnothing d_1$ EG M	P mm	d_1 mm	l_1 mm	l_2 mm	d_2 mm	α mm		
3	0.50	3.650	56	13.0	4.0	3.0	3	3.15
4	0.70	4.910	70	15.0	6.0	4.9	3	4.20
5	0.80	6.040	80	20.0	6.0	4.9	3	5.25
6	1.00	7.300	80	20.0	7.0	5.5	3	6.30
8	1.25	9.624	100	30.0	10.0	8.0	3	8.40
10	1.50	11.948	110	35.0	12.0	9.0	3	10.40

ID

149669
149688
149710
149723
149748
149767

EG UNC NASM33537



HSSE

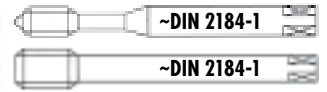

										N320-4	N420-4	N360-3	N460-3
N320-4													
N420-4													
N360-3													
N460-3													
$\varnothing'' d_1$ EG UNC	P TPI	d_1 mm	l_1 mm	l_2 mm	l_3 mm	d_2 mm	a mm			ID	ID		
4	40	3.67	56	13.0	20	4.0	3.0	3	3.05	110946			
6	32	4.53	70	15.0	25	6.0	4.9	3	3.75	110948			
8	32	5.19	70	15.0	25	6.0	4.9	3	4.45	110949			
10	24	6.20	80	17.0	30	7.0	5.5	3	5.10	* 110945			
1/4	20	8.00	90	20.0	35	8.0	6.2	3	6.70	110944			
5/16	18	9.77	100	22.0	39	10.0	8.0	3	8.40	110947			
3/8	16	11.59	110	24.0		9.0	7.0	3	10.00		110033		
1/2	13	15.23	110	30.0		12.0	9.0	3	13.30		104935		
$\varnothing'' d_1$ EG UNC	P TPI	d_1 mm	l_1 mm	l_2 mm	l_3 mm	d_2 mm	a mm			ID	ID		
4	40	3.67	56	6.5	20	4.0	3.0	3	3.05		110018		
6	32	4.53	70	9.0	25	6.0	4.9	3	3.75		110019		
8	32	5.19	70	9.0	25	6.0	4.9	3	4.45		110956		
10	24	6.20	80	11.0	30	7.0	5.5	3	5.10		110954		
1/4	20	8.00	90	12.5	35	8.0	6.2	3	6.70		110024		
5/16	18	9.77	100	14.0	39	10.0	8.0	3	8.40		111759		
3/8	16	11.58	110	14.0		9.0	7.0	3	10.00			111715	
1/2	13	15.23	110	18.0		12.0	9.0	3	13.30			111558	

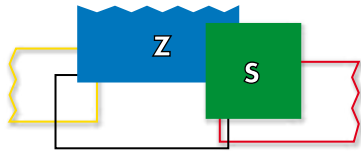

Z370VS-3

Z370VS-3

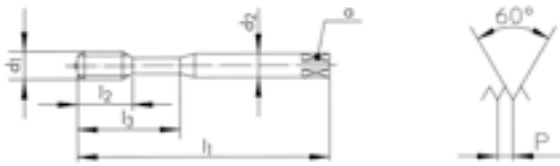
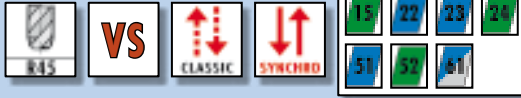

\varnothing " d ₁ EG UNC	P TPI	d ₁ mm	l ₁ mm	l ₂ mm	l ₃ mm	d ₂ h6 mm	a mm			ID
4	40	3.67	56	6.5	20	4.0 (h9)	3.0	3	3.05	165126
6	32	4.53	70	9.0	25	6.0	4.9	3	3.75	165127
8	32	5.19	70	9.0	25	6.0	4.9	3	4.45	165128



aero

										SA320-4	SA350-3	TL320VS-4	TL351VS-3
\varnothing d ₁ EG UNC	P TPI	d ₁ mm	l ₁ mm	l ₂ mm	l ₃ mm	d ₂ mm	a mm			ID	ID	ID	ID
4	40	3.67	56	13.0		4.0	3.0	3	3.05	149073	149075	* 152030	152031
6	32	4.53	70	15.0		6.0	4.9	3	3.75	149121	149123	* 152040	152041
8	32	5.19	70	15.0		6.0	4.9	3	4.45	149170	149172	* 152052	152053
1/4	20	8.00	90	18.0	29	8.0	6.2	3	6.70	149284	149286	* 152073	152074
5/16	18	9.77	100	20.0	33	10.0	8.0	3	8.40	* 149358	* 149360	* 152090	* 152091



HSSE

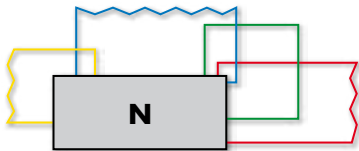
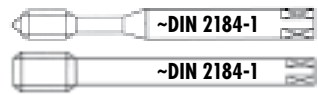

N320-4

N420-4

N360-3

N460-3



N320-4



N420-4



N360-3



N460-3



$\varnothing'' d_1$ EG UNF	P TPI	d_1 mm	l_1 mm	l_2 mm	l_3 mm	d_2 mm	α mm		
6	40	4.33	63	14.0	21	4.5	3.4	3	3.70
8	36	5.08	70	15.0	25	6.0	4.9	3	4.40
10	32	5.85	80	17.0	30	6.0	4.9	3	5.10
1/4	28	7.52	90	20.0	35	8.0	6.2	3	6.65
5/16	24	9.31	90	20.0	35	9.0	7.0	3	8.20
3/8	24	10.89	100	19.0		8.0	6.2	3	9.80
1/2	20	14.35	100	24.0		11.0	9.0	3	13.10

ID

ID

118879

118882

104941

110234

118876

118873

118865

$\varnothing'' d_1$ EG UNF	P TPI	d_1 mm	l_1 mm	l_2 mm	l_3 mm	d_2 mm	α mm		
6	40	4.33	63	7.5	21	4.5	3.4	3	3.70
8	36	5.08	70	9.0	25	6.0	4.9	3	4.40
10	32	5.85	80	11.0	30	6.0	4.9	3	5.10
1/4	28	7.52	90	12.5	35	8.0	6.2	3	6.65
5/16	24	9.31	90	12.5	35	9.0	7.0	3	8.20
3/8	24	10.89	100	19.0		8.0	6.2	3	9.80
1/2	20	14.35	100	14.0		11.0	9.0	3	13.10

ID

ID

110959

110960

104946

110020

111619

110027

104951

EG UNC
EG UNF

EG UNF NASM33537



PM

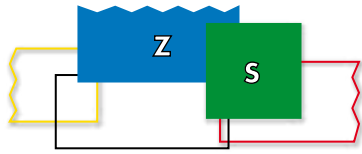
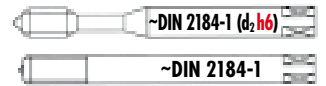

Z370VS-3 S320VS-4 S360VS-3 SA390-3



Z370VS-3

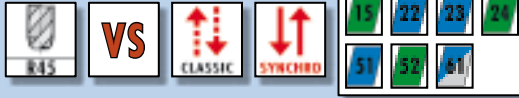

S320VS-4



S360VS-3



SA390-3

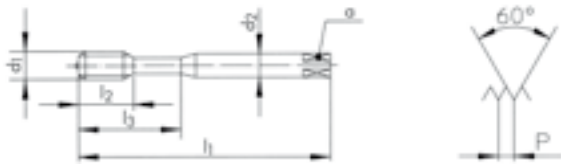

3B 3B 3B 3B

Ø" d ₁ EG UNF	P TPI	d ₁ mm	l ₁ mm	l ₂ mm	l ₃ mm	d ₂ h6 mm	a mm		
10	32	5.85	80	11.0	30	6.0	4.9	3	5.10
1/4	28	7.52	90	12.5	35	8.0	6.2	3	6.65
5/16	24	9.31	90	12.5	35	*8.0	*6.2	3	8.20

ID
165129
165130
165131

* Norme DC / * DC Norm / * Norma DC

Ø" d ₁ EG UNF	P TPI	d ₁ mm	l ₁ mm	l ₂ mm	l ₃ mm	d ₂ mm	a mm		
10	32	5.85	80	17.0	30	6.0	4.9	3	5.10
1/4	28	7.52	90	20.0	35	8.0	6.2	3	6.65
5/16	24	9.31	90	20.0	35	9.0	7.0	3	8.20

ID
111821
111822
111823

Ø" d ₁ EG UNF	P TPI	d ₁ mm	l ₁ mm	l ₂ mm	l ₃ mm	d ₂ mm	a mm		
10	32	5.85	80	11.0	30	6.0	4.9	3	5.10
1/4	28	7.52	90	12.5	35	8.0	6.2	3	6.65
5/16	24	9.31	90	12.5	35	9.0	7.0	3	8.20

ID
111811
111812
111824

Ø" d ₁ EG UNF	P TPI	d ₁ mm	l ₁ mm	l ₂ mm	d ₂ mm	a mm		
10	32	5.85	80	20.0	6.0	4.9	3	5.10
1/4	28	7.52	90	25.0	8.0	6.2	3	6.65

ID
149702
149724



aero

SA320-4

SA350-3

TL320VS-4

TL351VS-3

SA320-4



SA350-3



TL320VS-4



VS



TL351VS-3



VS

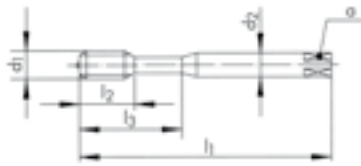

Ø" d ₁ EG UNF	P TPI	d ₁ mm	l ₁ mm	l ₂ mm	l ₃ mm	d ₂ mm	a mm		
10	32	5.85	80	15.0	23	6.0	4.9	3	5.10
1/4	28	7.52	90	18.0	29	8.0	6.2	3	6.65
5/16	24	9.31	90	20.0	31	9.0	7.0	3	8.20

ID

ID

ID

ID

149190

149192

* 148009

148008

146099

149268

* 148015

148014

149336

149338

148021

Общая информация

Корончатый метчик DC с рабочей поверхностью, „V“-обработанной для предотвращения холодной сварки, является высокопроизводительным инструментом, обеспечивающим высокое качество поверхности нарезаемой резьбы.

Сфера применения

Благодаря внутренней емкости для стружкоотвода во фронтальной части, корончатые метчики DC могут быть использованы для нарезания резьбы как в сквозных, так и в глухих отверстиях. Корончатый метчик может быть использован для материалов с пределом прочности до 850Н/мм² и коэффициентом удлинения максимум 30%

Использование

Корончатый метчик может быть использован для сквозных отверстий любой глубины. Однако, для оптимального нарезания в глухих отверстиях, отверстие под резьбу должно быть соответствующим и следующие инструкции должны выполняться:

- Нарезайте резьбу до срабатывания предохранительной муфты патрона
- Выверните метчик и очистите от стружки
- Нарезайте резьбу на полную глубину

Общие указания

Эффективная работа корончатых метчиков DC, также как и качество нарезаемой резьбы, зависят от соблюдения следующих правил:

- Не превышайте максимально допустимую погрешность центрирования инструмента в 0.1мм
- Метчик должен двигаться соосно отверстию, используйте резьбонарезной патрон
- Нарезайте резьбу с рекомендованной скоростью
- Выбирайте СОЖ в зависимости от материала, в котором будет нарезаться резьба
- Используйте патрон с осевой компенсацией и предохранительной муфтой
- Отрегулируйте предохранительную муфту таким образом, чтобы она срабатывала при достижении

Когда нарезаете первую резьбу, ослабьте предохранительную муфту до проскальзывания, затем постепенно затяните, пока метчик не начнет вращаться.

Сбор стружки

Объем стружкоотводящей емкости рассчитан на следующую глубину:

Диаметр резьбы	Ø 20 - 29 mm	≥ Ø 30 mm
M	-	1.4 x D
MF	1.2 x D	1.4 x D
UN-8	-	1.4 x D
G	1.2 x D	1.4 x D

Скорости резания и обороты шпинделя (рекомендованные) – Zalecane parametry skrawania

M				P				MF				UN-8			
M	P	V _c (m/min)	n (U/min)	MF	P	V _c (m/min)	n (U/min)	MF	P	V _c (m/min)	n (U/min)	UN-8	P TPI	V _c (m/min)	n (U/min)
30	3.5	7.9	84	22	1.5	8.0	116	45	1.5	6.9	49	1 1/4"	8.0	7.8	77
33	3.5	7.7	74	24	1.5	8.0	106	45	2.0	6.9	49	1 3/8"	8.0	7.6	69
36	4.0	7.5	66	26	1.5	7.9	97	48	1.5	6.6	44	1 1/2"	8.0	7.3	62
39	4.0	7.3	60	28	1.5	7.9	90	48	2.0	6.6	44	1 5/8"	8.0	7.1	55
42	4.5	7.1	54	30	1.5	7.9	84	48	3.0	6.6	44	1 3/4"	8.0	6.9	49
45	4.5	6.9	49	30	2.0	7.9	84	48	4.0	6.6	44	1 7/8"	8.0	6.7	45
48	5.0	6.6	44	32	1.5	7.8	77	50	1.5	6.5	41	2"	8.0	6.4	40
52	5.0	6.4	39	32	2.0	7.8	77	52	1.5	6.4	39				
56	5.5	6.1	35	33	1.5	7.7	74	52	3.0	6.4	39				
60	5.5	5.8	31	33	2.0	7.7	74	55	1.5	6.2	36				
64	6.0	5.5	28	34	1.5	7.6	71	56	4.0	6.1	35				
68	6.0	5.2	25	35	1.5	7.6	69	60	2.0	5.8	31				
				36	1.5	7.5	66	64	4.0	5.5	28				
				36	2.0	7.5	66	68	4.0	5.2	25				
				36	3.0	7.5	66	72	6.0	5.0	22				
				38	1.5	7.3	62	76	6.0	4.7	20				
				40	1.5	7.2	57	80	2.0	4.4	18				
				40	2.0	7.2	57	80	4.0	4.4	18				
				42	1.5	7.1	54	80	6.0	4.4	18				
				42	2.0	7.1	54	90	6.0	3.7	13				
				42	3.0	7.1	54	100	6.0	3.0	10				
				42	4.0	7.1	54	110	6.0	2.5	7				

Informacje ogólne

Waporyzowany („V“) gwintownik koronowy jest narzędziem o dużej wydajności, które oferuje bardzo dobrą jakość powierzchni wykonywanego gwintu. „V“- obróbka powierzchniowa zapobiegająca powstawaniu narostu.

Zastosowanie

Dzięki wybraniu od frontu zapewniającemu miejsce na gromadzenie wióra, gwintownik koronowy DC jest odpowiedni do gwintowania zarówno otworów przelotowych jak i nieprzelotowych. Gwintownik koronowy może być użyty w materiałach o wytrzymałości na rozciąganie do 850 N/mm² i o maksymalnym wydłużeniu 30 %.

Wykorzystanie

Gwintownik koronowy może być użyty do otworów przelotowych każdej głębokości. Jednakże do optymalnego gwintowania otworów nieprzelotowych, głębokość otworu pod gwint musi być odpowiednio dostosowana i powinny zostać spełnione poniższe warunki:

- Gwintuj do momentu zadziałania sprzęgła w oprawce
- Wycofaj gwintownik i usuń wióry
- Gwintuj na pełną głębokość

Ogólne wskazówki

Wydajna praca gwintownikami koronowymi DC, jak również jakość wykonywanych gwintów zależy od poniższych zasad:

- Nie przekraczaj maksymalnego dopuszczalnego błędu centrozwania, 0.1 mm
- Gwintownik musi pracować współosiowo, używaj odpowiedniej oprawki
- Gwintuj z odpowiednią prędkością skrawania
- Wybierz odpowiednie chłodziwo do materiału, który będzie gwintowany
- Użyj oprawki z kompensacją osiową i sprzęgłem przeciążeniowym
- Ustaw sprzęgło przeciążeniowe tak, aby zadziałało tuż powyżej przewidywanej wartości momentu obrotowego.

Kiedy gwintujesz pierwszy otwór, poluzuj sprzęgło aż do uzyskania poślizgu, następnie stopniowo dokręć je do momentu, aż gwintownik zacznie się obracać.

Gromadzenie wióra

Pojemność wybrania na gromadzenie wióra jest następująca:

Srednica gwintu	Ø 20 - 29 mm	≥ Ø 30 mm
M	-	1.4 x D
MF	1.2 x D	1.4 x D
UN-8	-	1.4 x D
G	1.2 x D	1.4 x D

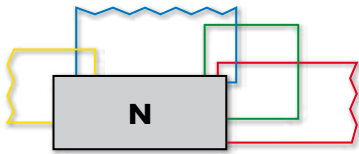

N470V-4

N470V-4

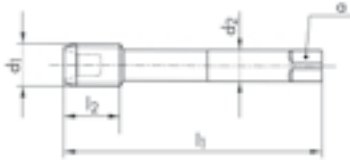

$\varnothing d_1$ M	P mm	l_1 mm	l_2 mm	d_2 mm	a mm			ID
30	3.50	180	39.0	22.0	18.0	5	26.50	102575
33	3.50	180	39.0	22.0	18.0	5	29.50	* 102576
36	4.00	200	43.0	25.0	20.0	5	32.00	102577
39	4.00	200	43.0	25.0	20.0	5	35.00	102578
42	4.50	220	47.0	28.0	22.0	5	37.50	102579
45	4.50	220	47.0	28.0	22.0	5	40.50	102580
48	5.00	240	52.0	32.0	24.0	5	43.00	102581
52	5.00	240	52.0	32.0	24.0	5	47.00	102582
56	5.50	260	58.0	36.0	29.0	6	50.50	102583
60	5.50	260	58.0	36.0	29.0	6	54.50	102584
64	6.00	290	64.0	40.0	32.0	6	58.00	102585
68	6.00	290	64.0	40.0	32.0	6	62.00	* 102586



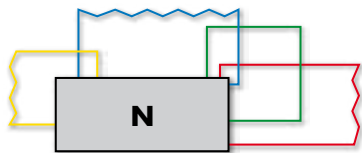

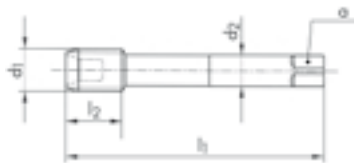

N470V-3

N470V-3



ISO 2
6H

$\varnothing d_1$ MF	P mm	l_1 mm	l_2 mm	d_2 mm	a mm			ID
Δ22	1.50	125	28.0	18.0	14.5	4	20.50	* 102526
Δ26	1.50	140	30.0	18.0	14.5	4	24.50	* 102529
Δ28	1.50	140	30.0	20.0	16.0	4	26.50	* 102530
30	1.50	160	32.0	22.0	18.0	5	28.50	* 102531
32	1.50	160	32.0	22.0	18.0	5	30.50	* 102533
34	1.50	160	26.0	22.0	18.0	5	32.50	* 102537
35	1.50	175	28.0	25.0	20.0	5	33.50	* 102538
36	2.00	175	35.0	25.0	20.0	5	34.00	102540
36	3.00	200	43.0	25.0	20.0	5	33.00	102541
38	1.50	175	28.0	25.0	20.0	5	36.50	* 102542
40	1.50	190	31.0	28.0	22.0	5	38.50	* 102543
40	2.00	190	38.0	28.0	22.0	5	38.00	* 102544
42	2.00	190	38.0	28.0	22.0	5	40.00	102546
42	3.00	220	47.0	28.0	22.0	5	39.00	102547
48	1.50	205	34.0	32.0	24.0	5	46.50	* 102551
48	3.00	205	41.0	32.0	24.0	5	45.00	102553
52	3.00	205	41.0	32.0	24.0	5	49.00	102557
56	4.00	260	58.0	36.0	29.0	6	52.00	102559
64	4.00	290	64.0	40.0	32.0	6	60.00	102561
80	4.00	270	56.0	45.0	35.0	7	76.00	* 102564



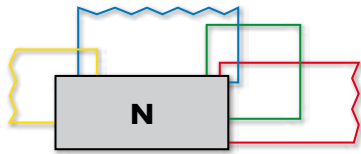



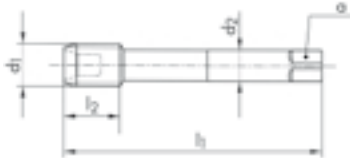

N470V-3

N470V-3

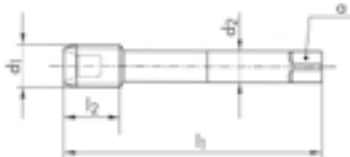

$\varnothing'' d_1$ UN	P TPI	d_1 mm	l_1 mm	l_2 mm	d_2 mm	a mm			ID
1 1/4	8	31.75	180	39.0	22.0	18.0	5	28.70	102566
1 3/8	8	34.92	180	39.0	22.0	18.0	5	31.80	102568
1 1/2	8	38.10	200	43.0	25.0	20.0	5	35.00	102565
1 5/8	8	41.27	220	47.0	28.0	22.0	5	38.20	102569
1 3/4	8	44.45	220	47.0	28.0	22.0	5	41.40	102567
1 7/8	8	47.62	240	52.0	32.0	24.0	5	44.50	102570
2	8	50.80	205	41.0	32.0	24.0	5	47.70	102572
2 1/4	8	57.15	220	45.0	36.0	29.0	6	54.10	102571
2 1/2	8	63.50	220	45.0	36.0	29.0	6	60.40	111879



$\varnothing'' d_1$ G	P TPI	d_1 mm	l_1 mm	l_2 mm	d_2 mm	a mm			ID
Δ 1/2	14	20.95	140	32.0	16.0	12.0	4	18.90	* 102521
Δ 3/4	14	26.44	150	34.0	20.0	16.0	4	24.40	102525
1	11	33.24	160	32.0	22.0	18.0	5	30.70	102522
1 1/4	11	41.91	190	38.0	28.0	22.0	5	39.30	102519
1 1/2	11	47.80	205	41.0	32.0	24.0	5	45.20	102518
1 3/4	11	53.74	205	41.0	32.0	24.0	5	51.20	* 102520 Δ
2	11	59.61	220	45.0	36.0	29.0	6	57.00	102524



КОМБИНИРОВАННЫЕ СВЕРЛА/МЕТЧИКИ

Общая информация

ДС комбинированные сверла/метчики – два инструмента в одном, который позволяет сверлить и нарезать резьбу не меняя инструмента.

Являются оптимальным решением для станков с ЧПУ, сверлильных головок, револьверных и резьбонарезных станков.

Сфера применения

ДС комбинированные сверла/метчики рекомендуется использовать по материалам с пределом прочности до 750 Н/мм², таким как определенные стали, чугуны, алюминий, латунь.

Общие положения

- Отверстие под резьбу должно быть полностью просверлено до того как метчик начнет нарезание.
- В короткостружечных материалах глубина резьбы не должна превышать 1.8 x D (min N5952 до 2 x D).
- В короткостружечных материалах глубина резьбы не должна превышать 1.2 x D.
- Смазка как при нарезании резьбы.

Скорости резания

Для сверлильных головок и станков с ЧПУ, идеальные скорости сверления и нарезания резьбы подобраны (см. стр.7 таблицы применяемости).

Если для сверления и нарезания резьбы выбираются одинаковые скорости, мы рекомендуем значения, приведенные ниже.

Инструкции по программированию

Зенкование:

Центровка и зенкование одновременно.

Программирование для 100 % синхронизированных подачи шпинделя и вращения (идеальный случай):

- 1) Комбинированное сверло/метчик в позиции быстрого старта
- 2) Сверление:
 - установить скорость
 - установить подачу
 - избегать длинной стружки
 - очистить стружку
- 3) Резьбонарезная секция в позиции старта
- 4) Нарезание резьбы:
 - установить скорость
 - подача = 100 % шаг резьбы
 - установить глубину резьбы
 - перед началом работы метчик должен быть очищен от стружки
- 5) Комбинированный сверло/метчик возвращается в позицию старта.

Программирование для случаев когда подача шпинделя и вращение не полностью синхронизированы:

Важно: Установите комбинированное сверло-метчик в патрон, защелкнув пружину, но вытянув осевую компенсацию.

- 1) Комбинированное сверло/метчик в позиции быстрого старта
- 2) Сверление:
 - установить скорость
 - установить подачу
 - избегать длинной стружки
 - очистить стружку
- 3) Резьбонарезная секция в позиции старта
- 4) Нарезание резьбы:
 - Установить скорость
 - подача = 90 - 95 % шага резьбы
 - установить глубину резьбы
- 5) Комбинированный сверло/метчик возвращается в позицию старта.

Скорости резания и вращения шпинделя (рекомендованные значения)

Группы материалов	Vc (м/мин)	Скорости для различных диаметров										
		M3	M4	M5	M6	M8	M10	M12	M14	M16	M18	M20
Стали до 500 Н/мм ²	20	2120	1600	1270	1060	800	640	530	460	400	360	320
Стали свыше 500 Н/мм ²	15	1600	1200	950	800	600	480	400	340	300	270	240
Чугун, мягкий	20	2120	1600	1270	1060	800	640	530	460	400	360	320
Чугун, твердый	15	1600	1200	950	800	600	480	400	340	300	270	240
Латунь	25	2650	2000	1600	1330	950	800	660	570	500	450	400
Алюминий	25	2650	2000	1600	1330	950	800	660	570	500	450	400

WIERTŁO-GWINTOWNIKI

Informacje ogólne

Wiertło-gwintowniki DC – dwa narzędzia w jednym - pozwalają na wiercenie oraz gwintowanie detalu bez zmiany narzędzia.

Jest to optymalne rozwiązanie dla obrabiarek CNC, głowic wiertarskich, tokarek rewolwerowych oraz gwintciarek.

Zastosowanie

Wiertło-gwintowniki DC są rekomendowane do obróbki materiałów o wytrzymałości na rozciąganie do 750 N/mm², takich jak stal, żeliwo szare, aluminium, mosiądz.

Ogólne wskazówki

- Obrabiany otwór musi być całkowicie przewiercony zanim gwintownik zacznie pracę.
- W materiałach z krótkim wiórem długość gwintu nie powinna przekroczyć 1.8 x D (typ N5952 do 2 x D).
- W materiałach z długim wiórem długość gwintu nie powinna przekroczyć 1.2 x D.
- Chłodziwo jak przy gwintowaniu.

Prędkości skrawania

Dla głowic wiertarskich i obrabiarek CNC dobrane są idealne prędkości przy wierceniu i gwintowaniu (patrz nasza tabela zastosowań na stronie 7).

Jeżeli ta sama prędkość jest dobrana zarówno do wiercenia jak i gwintowania, my zalecamy wartości podane poniżej.

Instrukcje programowania

Pogłębianie :

Nawiercaj i pogłębiaj jednocześnie.

Kroki programowania przy posuwie i obrotach wrzeciona w 100 % zsynchronizowanych (idealny przypadek) :

- 1) Wiertło-gwintownik w pozycji startowej (szybki posuw)
- 2) Wiercenie:
 - ustaw prędkość
 - ustaw posuw
 - zapobiegaj długim wiórom
 - usuwaj wióry
- 3) Gwintowanie - pozycja startowa
- 4) Gwintowanie:
 - ustaw prędkość
 - posuw = 100 % skoku
 - ustaw długość gwintu
 - gwintownik musi być wolny od wiórów, zanim zacznie nacinać gwint
- 5) Wiertło-gwintownik powraca na pozycję startową









Kroki programowania przy braku pełnej synchronizacji posuwu i obrotów wrzeciona :

Ważne: Zamocuj wiertło-gwintownik w oprawce z jednostronną kompensacją osiową (na wyciąganie).

- 1) Wiertło-gwintownik w szybkiej pozycji startowej
- 2) Wiercenie:
 - ustaw prędkość
 - ustaw posuw
 - zapobiegaj długim wiórom
 - usuwaj wióry
- 3) Gwintowanie – pozycja startowa
- 4) Gwintowanie:
 - ustaw prędkość
 - posuw = 90 – 95 % skoku
 - ustaw długość gwintowania
- 5) Wiertło-gwintownik powraca na pozycję startową.

Prędkości skrawania (wartości zalecane)

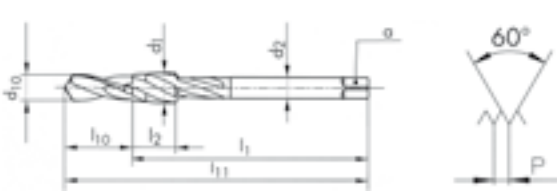

Grupy materiałowe	Vc (m/min)	Prędkości dla różnych średnic										
		M3	M4	M5	M6	M8	M10	M12	M14	M16	M18	M20
Stale do 500 N/mm ²	20	2120	1600	1270	1060	800	640	530	460	400	360	320
Stale powyżej 500 N/mm ²	15	1600	1200	950	800	600	480	400	340	300	270	240
Żeliwo szare, miękkie	20	2120	1600	1270	1060	800	640	530	460	400	360	320
Żeliwo szare, twarde	15	1600	1200	950	800	600	480	400	340	300	270	240
Mosiądz	25	2650	2000	1600	1330	950	800	660	570	500	450	400
Aluminium	25	2650	2000	1600	1330	950	800	660	570	500	450	400

								N5951	N5952	N5951	
N5951											
N5952											
N5951											
											
								ISO 2 6H	ISO 2 6H	7H EN 60423	
$\varnothing d_1$	P	l_{11}	l_2	d_2	α	d_{10}	l_{10}	ID			
M	mm	mm	mm	mm	mm	mm	mm				
3	0.50	62.0	12.5	3.5	2.7	2.55	9.0	104578			
4	0.70	66.0	16.0	4.5	3.4	3.36	10.0	104580			
5	0.80	75.5	18.0	6.0	4.9	4.26	12.5	104583			
6	1.00	81.0	20.0	6.0	4.9	5.05	14.0	104585			
8	1.25	93.0	12.0	6.0	4.9	6.80	20.0	104588			
10	1.50	99.0	14.0	7.0	5.5	8.55	22.0	104571			
12	1.75	106.0	16.0	9.0	7.0	10.30	25.0	104573			
16	2.00	123.0	20.0	12.0	9.0	14.10	32.0	104576			
20	2.50	132.0	22.0	16.0	12.0	17.60	36.0	104577			
$\varnothing d_1$	P	l_{11}	l_2	d_2	α	d_{10}	l_{10}	ID			
M	mm	mm	mm	mm	mm	mm	mm				
4	0.70	77.0	16.0	4.5	3.4	3.36	21.0	104608			
5	0.80	87.0	18.0	6.0	4.9	4.26	24.0	104609			
6	1.00	94.0	20.0	6.0	4.9	5.05	27.0	104610			
8	1.25	109.0	12.0	6.0	4.9	6.80	36.0	104611			
10	1.50	118.0	14.0	7.0	5.5	8.55	41.0	104603			
$\varnothing d_1$	P	l_{11}	l_2	d_2	α	d_{10}	l_{10}	ID			
MF	mm	mm	mm	mm	mm	mm	mm				
4	0.50	66.0	16.0	4.5	3.4	3.55	10.0	* 104579			
5	0.75	75.5	18.0	6.0	4.9	4.31	12.5	* 123379			
8	1.00	93.0	12.0	6.0	4.9	7.05	20.0	104587			
10	1.00	99.0	14.0	7.0	5.5	9.05	22.0	104570			
$\varnothing d_1$	P	l_{11}	l_2	d_2	α	d_{10}	l_{10}	ID			
MF	mm	mm	mm	mm	mm	mm	mm				
12	1.50	106.0	16.0	9.0	7.0	10.55	25.0	142825			
16	1.50	123.0	16.0	12.0	9.0	14.55	32.0	142826			
20	1.50	132.0	18.0	16.0	12.0	18.55	36.0	111844			
25	1.50	155.0	22.0	18.0	14.5	23.55	45.0	111845			
32	1.50	170.0	24.0	22.0	18.0	30.55	50.0	111846			

UNC ANSI B1.1 G DIN ISO 228 PG DIN 40430

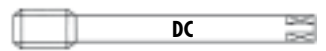
HSSE

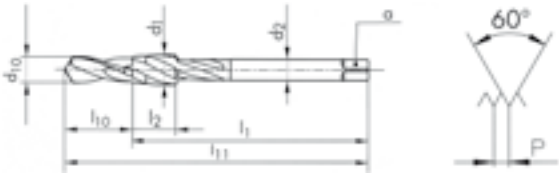

N5951									
									
									
									
2B									
\varnothing " d_1	P	d_1	l_{11}	l_2	d_2	α	d_{10}	l_{10}	ID
UNC	TPI	mm	mm	mm	mm	mm	mm	mm	
6	32	3.50	66.0	16.0	4.0	3.0	2.80	10.0	* 104601
10	24	4.82	75.5	18.0	4.5	3.4	3.86	12.5	* 104598
1/4	20	6.35	81.0	20.0	7.0	5.5	5.15	14.0	* 104597
1/2	13	12.70	106.0	16.0	9.0	7.0	10.85	25.0	* 104596
\varnothing " d_1	P	d_1	l_{11}	l_2	d_2	α	d_{10}	l_{10}	ID
G	TPI	mm	mm	mm	mm	mm	mm	mm	
1/8	28	9.72	93.0	12.0	7.0	5.5	8.75	20.0	104567
1/4	19	13.15	106.0	14.0	11.0	9.0	11.75	25.0	104566
3/8	19	16.66	123.0	16.0	12.0	9.0	15.25	32.0	104569
1/2	14	20.95	132.0	18.0	16.0	12.0	19.00	36.0	104565
3/4	14	26.44	155.0	22.0	18.0	14.5	24.45	45.0	* 104568
\varnothing d_1	P	d_1	l_{11}	l_2	d_2	α	d_{10}	l_{10}	ID
PG	TPI	mm	mm	mm	mm	mm	mm	mm	
7	20	12.50	106.0	14.0	9.0	7.0	11.40	25.0	* 104594
9	18	15.20	114.0	15.0	12.0	9.0	13.95	28.0	* 104595
13.5	18	20.40	132.0	18.0	16.0	12.0	19.15	36.0	* 104590
16	18	22.50	142.0	20.0	18.0	14.5	21.25	40.0	* 104591
29	16	37.00	203.0	28.0	28.0	22.0	35.65	63.0	* 104593



КОДИРОВКА – KODYFIKACJA

DC Резьбовые твердосплавные микрофрезы DC Cyrkularne, pełnowęglkowe frezy do gwintów



Пример - Przykład

Резьбовые микрофрезы	Циркулярные фрезы до гвинтов	GW					
Однозубые	jednoostrzowy		10				
Однопрофильные, многозубые	Pojedynczy profil, wieloostrzowy		20				
Многозубые, с двойным профилем	Podwójny profil, wieloostrzowy		30				
С полным профилем	Wieloostrzowy o pełnym profilu		40				
Длина резьбы 2.5 x D ₁	Długość gwintu 2.5 x D ₁			16			
Длина резьбы 4 x D ₁	Długość gwintu 4 x D ₁			19			
Износостойкое покрытие	Powłoka zabezpieczająca przed zużyciem					VS	
Специальное исполнение	Specjalne wykonanie						SP

DC Твердосплавные резьбовые фрезы DC Pełnowęglkowe frezy do gwintów



Пример - Przykład

Стандартное исполнение	Wykonanie standardowe	GF					
Для закаленных сталей (55 - 63 HRC)	Do stali utwardzonych (55 - 63 HRC)	GFH					
С фаской 45° для зенкования	Z fazą 45° do pogłębienia	GFS					
Резьбовые фрезы для разных диаметров резьбы	Frezy uniwersalne dla różnych średnic gwintów	GFM					
Фрезы-сверла	Wiertło-frezy	BGF					
Спиральные канавки 27° (GF), 10° (GHF)	Rowki wiórowe skrętne 27° (GF), 10° (GHF)		61				
Спиральные канавки 27° (GFS)	Rowki wiórowe skrętne 27° (GFS)		66				
Спиральные канавки 15° (GFM)	Rowki wiórowe skrętne 15° (GFM)		62				
Фрезы-сверла 2 кромки	Wiertło-frezy, 2 ostrza		67				
Фрезы-сверла 3 кромки	Wiertło-frezy, 3 ostrza		68				
Внешний подвод СОЖ	Chłodzenie zewnętrzne			1			
Внутренний подвод СОЖ	Chłodzenie wewnętrzne			6			
Длина резьбы 1.5 x D	Długość gwintu 1.5 x D				0		
Длина резьбы 2 x D	Długość gwintu 2 x D				5		
Длина резьбы 2.5 x D	Długość gwintu 2.5 x D				6		
Износостойкое покрытие	Powłoka zabezpieczająca przed zużyciem					VS	
Специальное исполнение	Specjalne wykonanie						SP

Пиктограммы/Примечания – Piktogramy



Твердый сплав
Monolit węglika



10° правые спиральные канавки
Rowki wiórowe prawoskrętne - 10°



15° правые спиральные канавки
Rowki wiórowe prawoskrętne - 15°



27° правые спиральные канавки
Rowki wiórowe prawoskrętne - 27°



27° правые спиральные канавки
Rowki wiórowe prawoskrętne - 27°



С фаской 45° для зенкования
Z fazą 45° do pogłębiania



Количество режущих кромок
Ilość ostrzy



Внутренний канал подвода СОЖ
Kanał do chłodzenia wewnętrznego



Внутренний канал подвода СОЖ (BGF, 2 кромки)
Kanał do chłodzenia wewnętrznego (BGF, 2 ostrza)



Внутренний канал подвода СОЖ (BGF, 3 кромки)
Kanał do chłodzenia wewnętrznego (BGF, 3 ostrza)



Износостойкое покрытие DC
Powłoka zabezpieczająca przed zużyciem



Резьба EG для резьбовых вставок
Gwint EG (pod wkładki HELICOIL)



Длина резьбы 2.5 x D₁
Długość gwintu 2.5 x D₁



Длина резьбы 4 x D₁
Długość gwintu 4 x D₁



Диаметр под резьбу
Średnica otworu



Длина резьбы 1.5 x D₁
Długość gwintu 1.5 x D₁



Длина резьбы 2 x D₁
Długość gwintu 2 x D₁



Длина резьбы 2.5 x D₁
Długość gwintu 2.5 x D₁



Внутренняя резьба
Gwint wewnętrzny



Наружная резьба
Gwint zewnętrzny



Для глухих отверстий (BGF)
Do otworów ślepych (BGF)



Для сквозных отверстий (BGF)
Do otworów przelotowych (BGF)



BGF, 2 кромки
BGF, 2 ostrza



BGF, 3 кромки
BGF, 3 ostrza



Для материалов < 63 HRC (GFH)
Do materiałów < 63 HRC (GFH)



Коническая резьба 1:16 (NPT - NPTF - Rc)
Gwint stożkowy 1:16 (NPT - NPTF)



Точность формы
Dokładność kształtu



Класс точности h5
Klasa tolerancji h5



Угол подъема спирали
Kąt pochylenia linii śrubowej



NIHS - Стандарт часовой промышленности Швейцарии
NIHS - norma szwajcarskich producentów zegarków

Примечание к фрезам GFM



Во избежание дефектов профиля резьбы, важно, чтобы диаметр инструмента не превышал 2/3 диаметра резьбы изделия для резьб с основным шагом (3/4 для резьб с мелким шагом)



Aby zapobiec powstawaniu defektów profilu gwintu należy pamiętać aby średnica narzędzia nie przekraczała 2/3 średnicy obrabianego otworu dla gwintów metrycznych (3/4 dla gwintów drobnozwojnych)

ПРЕИМУЩЕСТВА – ZALETY FREZÓW

GF-GFH-GFS-GFM

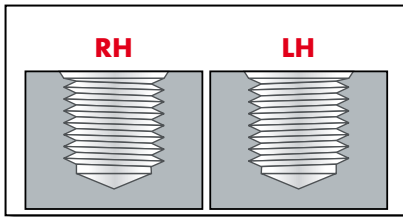

Одна и та же фреза может быть использована для образования правых и левых резьб
To samo narzędzie może wykonać gwinty prawe jak i lewe

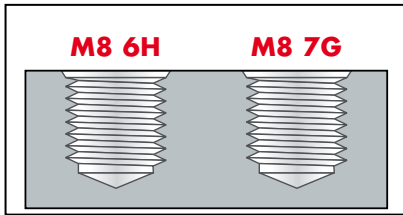

Может быть задан требуемый класс точности
Możliwość ustawienia tolerancji wg wymagań użytkownika

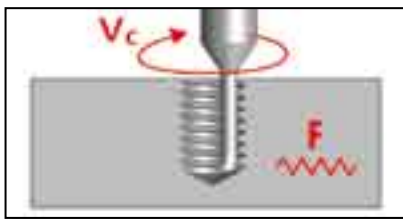

Одна фреза для обработки разных материалов. Хорош ший стружкоотвод благодаря оптимальному стружкодроблению
Jeden frez do obróbki różnych materiałów. Krótki wiór a dzięki temu dobra jego ewakuacja.

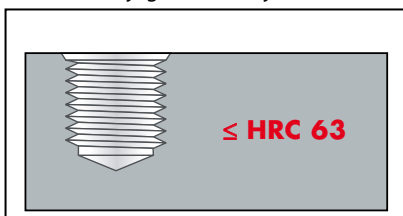

GFH

Для нарезания резьб в закаленных сталях (GW, GFH)
Do wykonania gwintów w materiałach utwardzonych (GW, GFH)

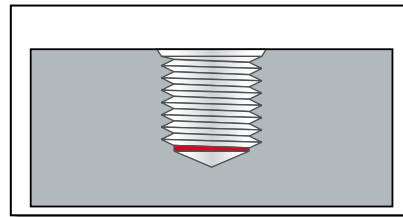

В глухих отверстиях резьбы могут быть нарезаны вплотную к доннышку

Do gwintów które muszą być nacinane blisko dna otworów nieprzelotowych

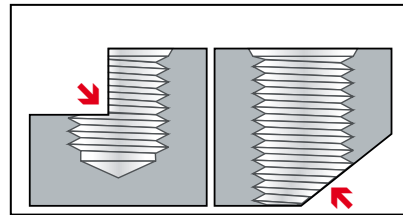

Могут быть использованы для резьб в отверстиях с неполными стенками на входе или выходе

Do gwintów przerywanych lub ze skośnym wejściem lub wyjściem

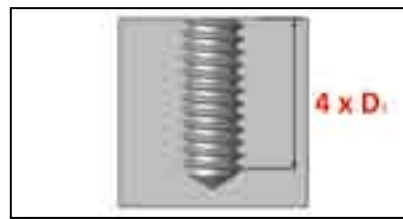

GW

Идеальны для глубоких глухих отверстий (GW)
Idealne do głębokich otworów nieprzelotowych

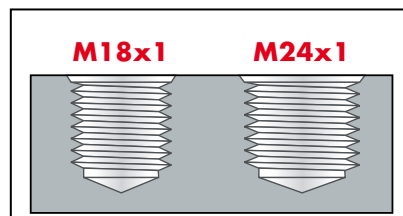

GFM

Один инструмент для большого диапазона резьб разного диаметра с одинаковым шагом
Tylko jedno narzędzie do gwintów w szerokim zakresie średnic o tym samym skoku

BGF

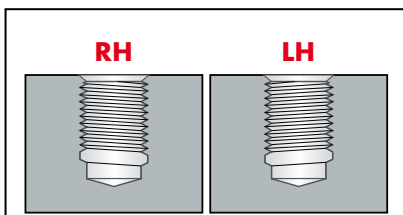

Одна и та же фреза может быть использована для образования правых и левых резьб
To samo narzędzie może wykonać gwinty prawe jak i lewe

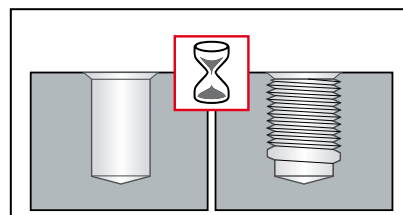

Экономия вспомогательного времени на замене инструмента и пространства в магазине станка
Oszczędność czasu wymiany narzędzia oraz miejsca w magazynie obrabiarki

Правое попутное фрезерование – Frezowanie prawostronne od dna otworu

GW1016
GW1016VS
GW2016
GW2016VS

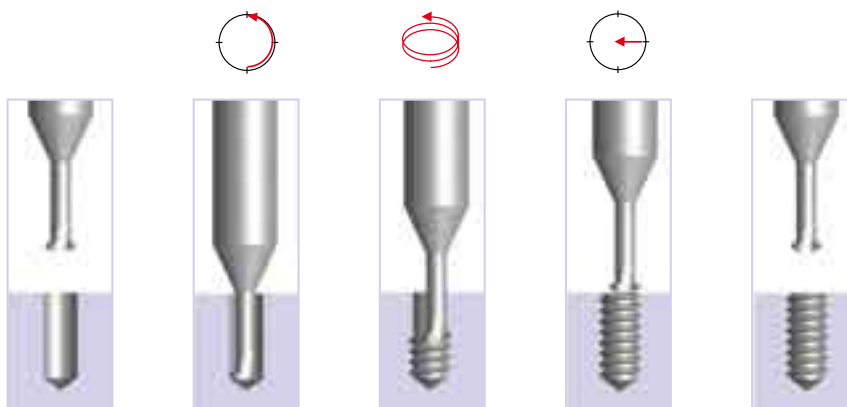

Традиционное правое резьбофрезерование – Konwencjonalne frezowanie prawostronne

GW3016
GW3016VS
GW3019
GW3019VS
GW4016
GW4016VS
GW4019
GW4019VS

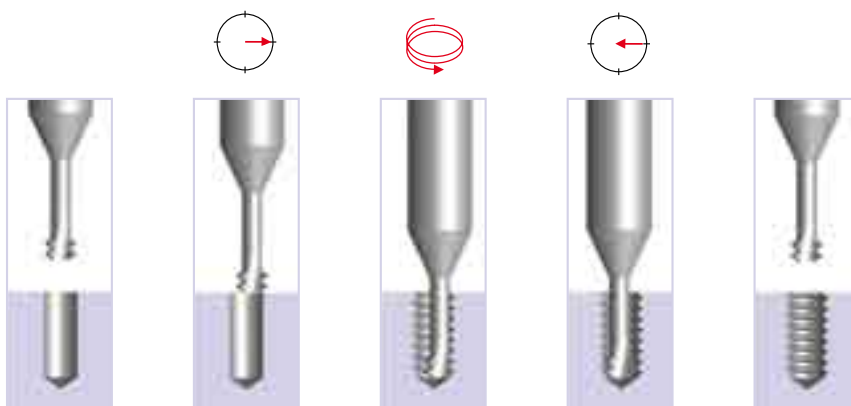

Рабочий цикл фрез типа GF – Cykl operacyjny, typ GF

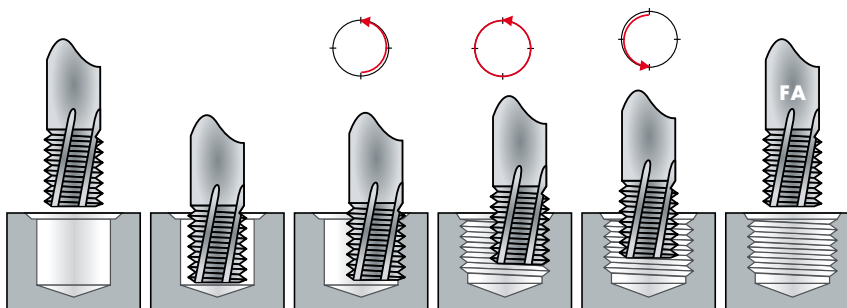

Рабочий цикл фрез типа BGF – Cykl operacyjny, typ BGF

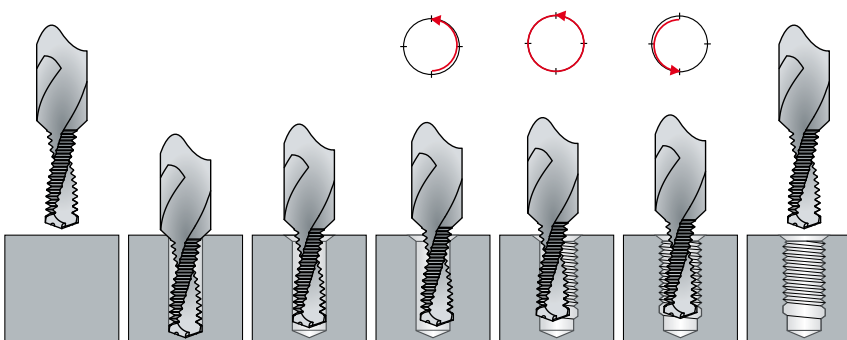

СКОРОСТИ РЕЗАНИЯ И ЗНАЧЕНИЯ ПОДАЧИ PRĘDKOŚCI SKRAWANIA ORAZ WARTOŚCI POSUWÓW

Специальные требования – Wymagania specjalne



ЧПУ станок с 3-D контролем

Obrabiarka CNC sterowana w 3 osiach



Высокоскоростное резание

Frezowanie wydajnościowe (wysokie parametry)

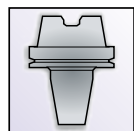

Высокая соосность крепления

Perfekcyjna koncentryczność mocowania

Таблица применения для резьбовых микрофрез
Tabela zastosowań dla cyrkularnych frezów do gwintów

Группы материалов Grupy materiałowe	Описание материалов	Означеніе материала	Твердость Twardość (HB)	Предел прочности Wytrzymałość на растяжение Rm (N/mm ²)
10 Стале Stale	11 Автоматные стали	Stale szybko tnące	< 200	< 700
	12 Структурные/цементуемые стали	Stale konstrukcyjne/nawęglane	< 200	< 700
	13 Углеродистые стали	Stale węglowe	< 300	< 1000
	14 Легированные < 850 N/mm ²	Stale stopowe < 850 N/mm ²	< 250	< 850
	15 Легированные стали > 850 - < 1150 N/mm ²	Stale stopowe > 850 - < 1150 N/mm ²	> 250	> 850
	16 Высокопрочные легированные стали 55 - 63 HRC	Stale stopowe o dużej wytrzymałości 55 - 63 HRC	> 250	> 850
20 Нержавеющие стали Stale nierdzewne	21 Легкообрабатываемые нержавеющие стали	Stale automatowe nierdzewne	< 250	< 850
	22 Аустенитные нержавеющие стали	Austenityczne stale nierdzewne	< 250	< 850
	23 Ферритные и мартенситные < 850 N/mm ²	Stale ferrytyczne i martenzytyczne < 850 N/mm ²	< 250	< 850
	24 Ферритные и мартенситные > 850 - < 1150 N/mm ²	Stale ferrytyczne i martenzytyczne > 850 - < 1150 N/mm ²	> 250	> 850
30 Чугун Żeliwo szare	31 Чугун	Żeliwo szare	< 250	< 850
	32 Ковкий и высокопрочный чугун	Żeliwo sferoidalne	< 250	< 850
40 Титан Tytan	41 Чистый титан	Чистый титан	< 250	< 850
	42 Титановые сплавы	Stopy tytanu	> 250	> 850
50 Никель Nikiel	51 Никелевые сплавы 1 < 850 N/mm ²	Stopy niklu 1 < 850 N/mm ²	< 250	< 850
	52 Никелевые сплавы 2 > 850 - < 1150 N/mm ²	Stopy niklu 2 > 850 - < 1150 N/mm ²	> 250	> 850
	53 Никелевые сплавы 3 > 1150 - ≤ 1600 N/mm ²	Stopy niklu 3 > 1150 - ≤ 1600 N/mm ²	> 340	> 1150
60 Медь Miedź	61 Чистая медь (электротехническая)	Чистая медь (медь электролитическая)	< 120	< 400
	62 Короткостружечная латунь	Mosiądz z krótkim wiórem, brąz fosforowy, brąz armatni	< 200	< 700
	63 Длинностружечная латунь	Mosiądz z długim wiórem	< 200	< 700
70 Алюминий, Магний Aluminium, Magnez	71 Нелегированный алюминий	Алюминий нестоповое	< 100	< 350
	72 Алюминий Si < 1.5 %	Stopy aluminium Si < 1.5 %	< 150	< 500
	73 Алюминий Si > 1.5 % - < 10 %	Stopy aluminium Si > 1.5 % - < 10 %	< 120	< 400
	74 Алюминий Si > 10 %, сплавы магния	Stopy aluminium Si > 10 %, Stopy magnezu	< 120	< 400
80 Сложные пластики, компануды Tworzywa sztuczne	81 Термопластики	Tworzywa sztuczne - termoplasty	-	-
	82 Дуропластики	Tworzywa sztuczne - duroplasty	-	-
	83 Стеклопластики	Tworzywa sztuczne wzmacniane włóknem szklanym	-	-
90 Драгоценные металлы M. szlachetny	91 Желтое золото	Żółte złoto	-	-
	92 Красное золото	Czerwone złoto	-	-
	93 Белое золото	Białe złoto	-	-
	94 Серебро	Srebro	-	-

Оптимально с маслом
 Допустимо с маслом

Optymalne z chłodzeniem olejowym
 Możliwe z chłodzeniem olejowym

Оптимально с эмульсией
 Допустимо с эмульсией

Optymalne z chłodzeniem emulsją
 Możliwe z chłodzeniem emulsją

GW

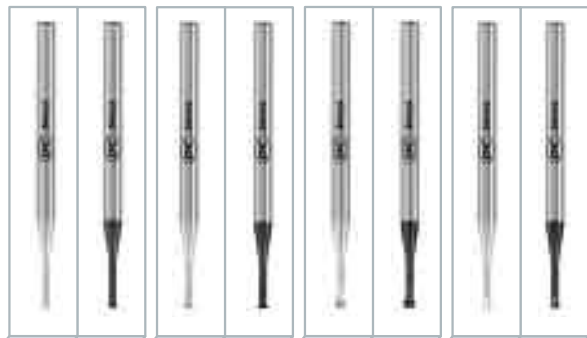

GW1016

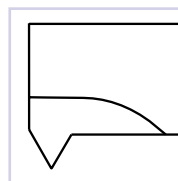

GW2016

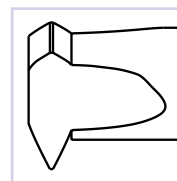

GW3016/19

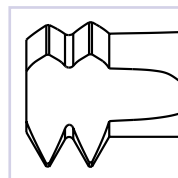

GW4016/19

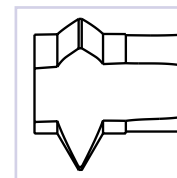

		Vc (m/min)		Значение подачи fz (мм/зуб)				Frezowanie fz (mm/ząb)		
		Стандартный Standard	С покрытием VS Powlekany „VS”	Ø 0.3 - 1.0	Ø 1.01 - 3.0	Ø 3.01 - 6.0	Ø 6.01 - 12.0			
SE	SE	60 - 80	80 - 100	0.004 - 0.01	0.01 - 0.05	0.04 - 0.10	0.08 - 0.15			11
SE	SE	60 - 80	80 - 100	0.004 - 0.01	0.01 - 0.05	0.04 - 0.10	0.08 - 0.15			12
SE	SE	50 - 70	70 - 90	0.004 - 0.01	0.01 - 0.05	0.02 - 0.10	0.05 - 0.15			13
SE	SE	50 - 70	70 - 90	0.004 - 0.01	0.01 - 0.05	0.02 - 0.10	0.05 - 0.15			14
SE	SE	15 - 35	30 - 50	0.004 - 0.01	0.01 - 0.05	0.02 - 0.08	0.04 - 0.15			15
	SE		15 - 40	0.003 - 0.01	0.006 - 0.03	0.008 - 0.05	0.01 - 0.08			16
	SE		40 - 60	0.004 - 0.01	0.01 - 0.05	0.02 - 0.10	0.05 - 0.15			21
	SE		30 - 50	0.004 - 0.01	0.01 - 0.03	0.02 - 0.05	0.03 - 0.08			22
	SE		30 - 50	0.004 - 0.01	0.01 - 0.03	0.02 - 0.05	0.03 - 0.08			23
	SE		30 - 50	0.004 - 0.01	0.01 - 0.03	0.02 - 0.05	0.03 - 0.08			24
SE	SE	60 - 90	90 - 120	0.004 - 0.01	0.01 - 0.05	0.04 - 0.10	0.08 - 0.15			31
SE	SE	50 - 70	70 - 90	0.004 - 0.01	0.01 - 0.05	0.02 - 0.10	0.05 - 0.15			32
SE	SE	15 - 35	20 - 40	0.004 - 0.01	0.01 - 0.03	0.02 - 0.05	0.03 - 0.08			41
SE	SE	10 - 30	15 - 35	0.004 - 0.01	0.01 - 0.03	0.02 - 0.05	0.03 - 0.08			42
	SE		20 - 40	0.004 - 0.01	0.01 - 0.03	0.02 - 0.05	0.03 - 0.08			51
	SE		20 - 40	0.004 - 0.01	0.01 - 0.03	0.02 - 0.05	0.03 - 0.08			52
	SE		20 - 30	0.003 - 0.01	0.006 - 0.03	0.008 - 0.05	0.01 - 0.08			53
SE	SE	150 - 200	200 - 250	0.004 - 0.01	0.01 - 0.05	0.02 - 0.10	0.05 - 0.15			61
SE	SE	100 - 150	150 - 200	0.004 - 0.01	0.01 - 0.05	0.04 - 0.10	0.08 - 0.15			62
SE	SE	100 - 150	150 - 200	0.004 - 0.01	0.01 - 0.05	0.02 - 0.10	0.05 - 0.15			63
SE		150 - 250		0.004 - 0.01	0.01 - 0.05	0.05 - 0.10	0.10 - 0.20			71
SE		150 - 250		0.004 - 0.01	0.01 - 0.05	0.05 - 0.10	0.10 - 0.20			72
SE	SE	150 - 250	200 - 300	0.004 - 0.01	0.01 - 0.05	0.05 - 0.10	0.10 - 0.20			73
SE	SE	150 - 250	200 - 300	0.004 - 0.01	0.01 - 0.05	0.04 - 0.10	0.08 - 0.15			74
E	E	150 - 250	200 - 300	0.004 - 0.01	0.01 - 0.05	0.05 - 0.10	0.10 - 0.20			81
E	E	80 - 150	100 - 200	0.004 - 0.01	0.01 - 0.05	0.04 - 0.10	0.08 - 0.15			82
	E		80 - 100	0.004 - 0.01	0.01 - 0.05	0.04 - 0.10	0.08 - 0.15			83
SE	SE	100 - 150	150 - 200	0.004 - 0.01	0.01 - 0.05	0.04 - 0.10	0.08 - 0.15			91
SE	SE	60 - 90	90 - 120	0.004 - 0.01	0.01 - 0.05	0.02 - 0.10	0.04 - 0.15			92
	SE		30 - 50	0.004 - 0.01	0.01 - 0.03	0.02 - 0.05	0.03 - 0.08			93
SE	SE	60 - 90	90 - 120	0.004 - 0.01	0.01 - 0.05	0.02 - 0.10	0.04 - 0.15			94

Значения носят рекомендательный характер. Zalecane wartości.

СКОРОСТИ РЕЗАНИЯ И ЗНАЧЕНИЯ ПОДАЧИ PRĘDKOŚCI SKRAWANIA I POSUWY

Таблица DC для резьбовых фрез и сверл-фрез
Tabela DC dla frezów do gwintów oraz wiertło-frezów

Группы материалов Grupy materiałowe	Описание материалов Примеры для групп применения, стр. 5.	Оznaczenie materiału Примеры для групп zastosowań, strona 6.	Твердость Twardość (HB)	Предел прочности Wytrzymałość на растяжение Rm (N/mm ²)
10 Стали Stale	11 Автоматные стали	Stale szybko tnące	< 200	< 700
	12 Структурные/цементуемые стали	Stale konstrukcyjne/nawęglane	< 200	< 700
	13 Углеродистые стали	Stale węglowe	< 300	< 1000
	14 Легированные <850 N/mm ²	Stale stopowe <850 N/mm ²	< 250	< 850
	15 Легированные стали >850 - <1150 N/mm ²	Stale stopowe >850 - <1150 N/mm ²	> 250	> 850
	16 Высокопрочные легированные стали	Stale stopowe o dużej wytrzymałości	> 250	> 850
	* Высокопрочные легированные стали 55 - 63 HRC	Stale stopowe o dużej wytrzymałości 55 - 63 HRC	> 560	> 2000
20 Нержавеющие стали Stale nierdzewne	21 Легкообрабатываемые нержавеющие стали	Stale automatowe nierdzewne	< 250	< 850
	22 Аустенитные нержавеющие стали	Austeniczne stale nierdzewne	< 250	< 850
	23 Ферритные и мартенситные <850 N/mm ²	Stale ferrytyczne i martenzytyczne <850 N/mm ²	< 250	< 850
	24 Ферритные и мартенситные >850 - <1150 N/mm ²	Stale ferrytyczne i martenzytyczne >850 - <1150 N/mm ²	> 250	> 850
30 Чугун Żeliwo szare	31 Чугун	Żeliwo szare	< 250	< 850
	32 Ковкий и высокопрочный чугун	Żeliwo sferoidalne	< 250	< 850
40 Титан Tytan	41 Чистый титан	Чистый титан	< 250	< 850
	42 Титановые сплавы	Stopy tytanu	> 250	> 850
50 Никель Nikiel	51 Никелевые сплавы 1 <850 N/mm ²	Stopy niklu 1 <850 N/mm ²	< 250	< 850
	52 Никелевые сплавы 2 >850 - <1150 N/mm ²	Stopy niklu 2 >850 - <1150 N/mm ²	> 250	> 850
	53 Никелевые сплавы 3 >1150 - ≤1600 N/mm ²	Stopy niklu 3 >1150 - ≤1600 N/mm ²	> 340	> 1150
60 Медь Miedź	61 Чистая медь (электротехническая)	Чистая медь (медь электролитическая)	< 120	< 400
	62 Короткостружечная латунь	Mosiądz z krótkim wiórem, brąz fosforowy, brąz armatni	< 200	< 700
	63 Длинностружечная латунь	Mosiądz z długim wiórem	< 200	< 700
70 Алюминий, Магний Aluminium, Magnez	71 Нелегированный алюминий	Алюминий нестоповое	< 100	< 350
	72 Алюминий Si < 1.5 %	Stopy aluminium Si < 1.5 %	< 150	< 500
	73 Алюминий Si > 1.5 % - < 10 %	Stopy aluminium Si > 1.5 % - < 10 %	< 120	< 400
	74 Алюминий Si > 10 %, сплавы магния	Stopy aluminium Si > 10 %, Stopy magnezu	< 120	< 400
80 Сложные пластики, компаннды Tworzywa sztuczne	81 Термопластики	Tworzywa sztuczne - termoplasty	-	-
	82 Дуропластики	Tworzywa sztuczne - duroplasty	-	-
	83 Стеклопластики	Tworzywa sztuczne wzmacniane włóknem szklanym	-	-

* Резьбовая фреза тип GFH

Frez do gwintu. Typ GFH

Подачи при фрезеровании резьбы

Подача

$$V_{fk} = f_z \times Z \times n$$

Значение подачи центра инструмента $V_{fm} = \frac{V_{fk} \times (\text{Номинальный диаметр резьбы} - \text{Диаметр резьбовой фрезы})}{\text{Номинальный диаметр резьбы}}$

Номинальный диаметр резьбы

На станках с ЧПУ, которые сами не вычисляют значение подачи для центра инструмента, это значение должно быть задано.

Posuwу przy frezowaniu gwintu

Wartość posuwu















$$V_{fk} = f_z \times Z \times n$$

Posuw liczony dla środka narzędzia $V_{fm} = \frac{V_{fk} \times (\text{Gwint nominalny } \varnothing - \text{Średnica freza } \varnothing)}{\text{Gwint nominalny } \varnothing}$

Gwint nominalny \varnothing

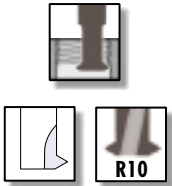
Na maszynach CNC, które nie obliczają same posuwu, wartość „środek narzędzia V_{fm} ” musi być określona

Указатель – Твердосплавные резьбовые микрофрезы тип GW
Skorowidz - Cyrkularne frezy do gwintów typ GW

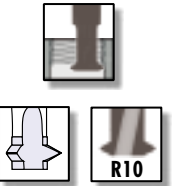
		GW									
Typ Typ		GW1016 GW1016VS	GW2016 GW2016VS	GW3016 GW3016VS	GW3019 GW3019VS	GW4016 GW4016VS	GW4019 GW4019VS	GW4016 GW4016VS	GW4019 GW4019VS	GW4016 GW4016VS	GW4019 GW4019VS
Покрытие Powłoka		VS		VS		VS		VS		VS	
											
Длина резьбы Długość gwintu											
Характеристики Charakterystyki											
M	ISO DIN 13 ISO DIN 14		207	208/209	208/209	212	212				
MF	ISO DIN 13			208/209	208/209						
UNC	ANSI B1.1			210	210	213	213				
UNF	ANSI B1.1			211	211	213	213				
S	NIHS	206	207								

Указатель – Твердосплавные резьбовые фрезы тип GF
 Skorowidz – Pełnowęglkowe frezy do gwintów, typ GF

		GF											
Тип Typ		GF6110	GF6110VS	GF6160	GF6160VS	GF6115	GF6115VS	GF6165	GF6165VS	GF6116	GF6116VS	GF6166	GF6166VS
Покрытие Powłoka		VS		VS		VS		VS		VS		VS	
Длина резьбы Długość gwintu													
Характеристики Charakterystyki													
M	ISO DIN 13	214				215		215		216		216	
MF	ISO DIN 13	217						218				218	
UNC	ANSI B1.1	219						220				220	
UNF	ANSI B1.1	221						222				222	
UN	ANSI B1.1												
G (BSP)	DIN ISO 228							223				223	
PG	DIN 40430												
NPT	ANSI B1.20.1			224									
NPTF	ANSI B1.20.3			224									
EG M	DIN 8140												

Указатель – Твердосплавные резьбовые фрезы тип GFH и GFS
 Skorowidz – Pełnowęglkowe frezy do gwintów, typ GFH i GFS

		GFH		GFS								
Тип Typ		GFH6110VS	GFS6610	GFS6610VS	GFS6660	GFS6660VS	GFS6615	GFS6615VS	GFS6665	GFS6665VS	GFS6616	GFS6616VS
Покрытие Powłoka												
Длина резьбы Długość gwintu												
Характеристики Charakterystyki												
M	ISO DIN 13	214	225	225	225	225	226	226	226	226	227	227
MF	ISO DIN 13		228	228	228	228	229	229	229	229		
UNC	ANSI B1.1		230	230	230	230	231	231	231	231		
UNF	ANSI B1.1		232	232	232	232	233	233	233	233		
UN/EF/S	ANSI B1.1											
G (BSP)	DIN ISO 228				234	234			234	234		
PG	DIN 40430											
NPT	ANSI B1.20.1				235	235						
NPTF	ANSI B1.20.3				235	235						
EG M	DIN 8140											

Указатель – Твердосплавные резьбовые фрезы фрезы-сверла тип GFM и BGF
 Skorowidz – Pełnowęglkowe frezy do gwintów i wiertło-frezy, typ GFM i BGF

		GFM		BGF									
GFS6666	GFS6666VS	GFM6260	GFM6260VS	BGF6760	BGF6760VS	BGF6765	BGF6765VS	BGF6766	BGF6766VS	BGF6865	BGF6865VS	BGF6866	BGF6866VS
VS		VS		VS		VS		VS		VS		VS	
227	236	240	241	241	242	242							
	236	243	243										
	237												
	237												
	237												
	238												
	239												
	239												

GW

GW1016



GW1016VS



GW1016

GW1016VS

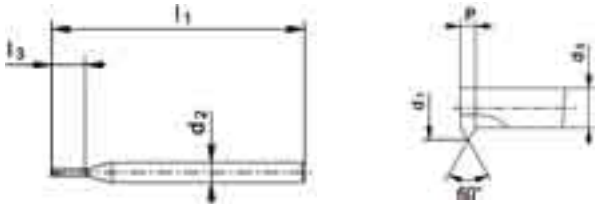

$\varnothing D_1$ S	P mm	d_1 mm	l_1 mm	l_3 mm	d_2 h5 mm	d_3 mm		
0.3	0.08	0.21	39	0.9	3	0.10	1	0.23 *
0.4	0.10	0.29	39	1.2	3	0.15	1	0.32 *
0.5	0.125	0.36	39	1.5	3	0.19	1	0.40 *
0.6	0.15	0.43	39	1.7	3	0.23	1	0.48 *
0.7	0.175	0.50	39	2.0	3	0.27	1	0.56 *
0.8	0.20	0.57	39	2.3	3	0.31	1	0.64 *
0.9	0.225	0.64	39	2.6	3	0.34	1	0.72 *
1.0	0.25	0.71	39	2.9	3	0.38	1	0.80 *
1.2	0.25	0.91	39	3.4	3	0.58	1	1.00 *
1.4	0.30	1.06	39	3.9	3	0.66	1	1.15 *

ID

ID

166930

166940

166931

166941

166932

166942

166933

166943

166934

166944

166935

166945

166936

166946

166937

166947

166938

166948

166939

166949

*Tol. +0.02 mm
0

GW

GW2016



GW2016VS

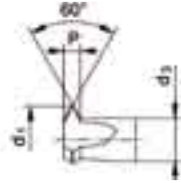
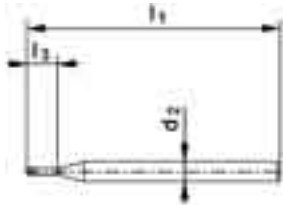

GW2016

GW2016VS



∅ D ₁	P	d ₁	l ₁	l ₃	d ₂ h5	d ₃		
S	mm	mm	mm	mm	mm	mm		→ ←

0.8	0.20	0.57	39	2.3	3	0.29	3	0.64 *
0.9	0.225	0.64	39	2.6	3	0.33	3	0.72 *
1.0	0.25	0.71	39	2.9	3	0.36	3	0.80 *
1.2	0.25	0.91	39	3.4	3	0.56	3	1.00 *
1.4	0.30	1.06	39	3.9	3	0.64	3	1.15 *

ID

ID

166969	166988
166970	166989
166971	166990
166972	166991
166973	166992

∅ D ₁	P	d ₁	l ₁	l ₃	d ₂ h5	d ₃		
M	mm	mm	mm	mm	mm	mm		→ ←

0.8	0.20	0.57	39	2.3	3	0.29	3	0.62
0.9	0.225	0.64	39	2.6	3	0.33	3	0.70
1.0	0.25	0.71	39	2.9	3	0.36	3	0.75
1.2	0.25	0.91	39	3.4	3	0.56	3	0.95
1.4	0.30	1.06	39	3.9	3	0.64	3	1.10
1.6	0.35	1.20	39	4.5	3	0.71	3	1.25
1.8	0.35	1.40	39	5.0	3	0.91	3	1.45
2.0	0.40	1.54	39	5.6	3	0.98	3	1.60
2.5	0.45	1.98	39	6.9	3	1.35	3	2.05
3.0	0.50	2.43	51	8.4	5	1.73	4	2.50
3.5	0.60	2.81	51	9.9	5	1.97	4	2.90
4.0	0.70	3.20	51	11.3	5	2.22	4	3.30
5.0	0.80	4.08	51	14.0	5	2.96	4	4.20
6.0	1.00	4.90	51	16.8	5	3.50	4	5.00

ID

ID

166974	166993
166975	166994
166976	166995
166977	166996
166978	166997
166979	166998
166980	166999
166981	167000
166982	167001
166983	167002
166984	167003
166985	167004
166986	167005
166987	167006

*Tol. +0.02 mm
0



h5

GW

GW3016



GW3016VS



GW3019



GW3019VS

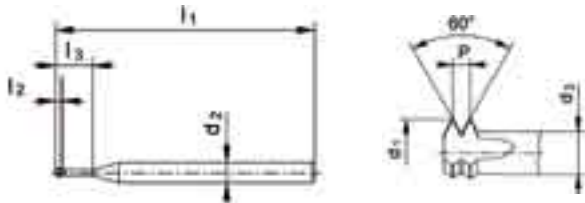

GW3016

GW3016VS

GW3019

GW3019VS



$\varnothing D_1$ M, MF	P	d_1	l_1	l_3	d_2 h5	d_3		
mm	mm	mm	mm	mm	mm	mm		\rightarrow \leftarrow

0.8	0.20	0.57	39	2.3	3	0.29	3	0.62
0.9	0.225	0.64	39	2.6	3	0.33	3	0.70
1.0	0.25	0.71	39	2.9	3	0.36	3	0.75
1.2	0.25	0.91	39	3.4	3	0.56	3	0.95
1.4	0.30	1.06	39	3.9	3	0.64	3	1.10
1.6	0.35	1.20	39	4.5	3	0.71	3	1.25
1.8	0.35	1.40	39	5.0	3	0.91	3	1.45
2.0	0.20	1.77	39	5.3	3	1.49	3	1.80
2.0	0.40	1.54	39	5.6	3	0.98	3	1.60
2.5	0.20	2.27	39	6.6	3	1.99	3	2.30
2.5	0.25	2.21	39	6.6	3	1.86	3	2.25
2.5	0.45	1.98	39	6.9	3	1.35	3	2.05

ID

ID

$\varnothing D_1$ M, MF	P	d_1	l_1	l_3	d_2 h5	d_3		
mm	mm	mm	mm	mm	mm	mm		\rightarrow \leftarrow

0.8	0.20	0.57	39	3.5	3	0.29	3	0.62
0.9	0.225	0.64	39	3.9	3	0.33	3	0.70
1.0	0.25	0.71	39	4.4	3	0.36	3	0.75
1.2	0.25	0.91	39	5.2	3	0.56	3	0.95
1.4	0.30	1.06	39	6.0	3	0.64	3	1.10
1.6	0.35	1.20	39	6.9	3	0.71	3	1.25
1.8	0.35	1.40	39	7.7	3	0.91	3	1.45
2.0	0.20	1.77	39	8.3	3	1.49	3	1.80
2.0	0.40	1.54	39	8.6	3	0.98	3	1.60
2.5	0.20	2.27	39	10.3	3	1.99	3	2.30
2.5	0.25	2.21	39	10.4	3	1.86	3	2.25
2.5	0.45	1.98	39	10.6	3	1.35	3	2.05

ID

ID

									167063	167077
									167064	167078
									167065	167079
									167066	167080
									167067	167081
									167068	167082
									167069	167083
									175254	175270
									167070	167084
									175255	175271
									175256	175272
									167071	167085

M, MF ISO DIN 13

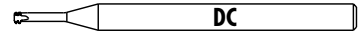

h5

GW

GW3016



R10

GW3016VS



R10

VS

GW3019



R10

GW3019VS



R10

VS

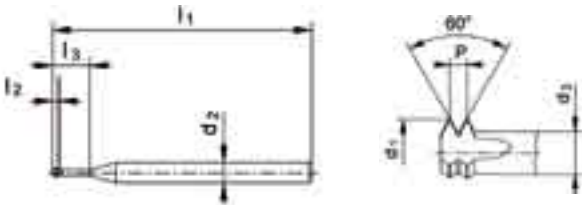

GW3016

GW3016VS

GW3019

GW3019VS



$\varnothing D_1$ M, MF	P mm	d_1 mm	l_1 mm	l_3 mm	d_2 h5 mm	d_3 mm		
3.0	0.35	2.60	51	8.2	5	2.11	4	2.65
3.0	0.50	2.43	51	8.4	5	1.73	4	2.50
3.5	0.60	2.81	51	9.9	5	1.97	4	2.90
4.0	0.70	3.20	51	11.3	5	2.22	4	3.30
5.0	0.80	4.08	51	14.0	5	2.96	4	4.20
6.0	1.00	4.85	51	16.8	5	3.45	4	5.00
8.0	1.25	5.95	63	23.0	6*	4.20	5	6.80
10.0	1.50	7.95	67	28.0	8*	5.85	5	8.50
12.0	1.75	9.95	76	34.0	10*	7.50	5	10.20

ID

ID

175228	175242
167030	167044
167031	167045
167032	167046
167033	167047
167034	167048
175229	175243
175230	175244
175231	175245

$\varnothing D_1$ M, MF	P mm	d_1 mm	l_1 mm	l_3 mm	d_2 h5 mm	d_3 mm		
3.0	0.35	2.60	51	12.7	5	2.11	4	2.65
3.0	0.50	2.43	51	12.9	5	1.73	4	2.50
3.5	0.60	2.81	51	15.1	5	1.97	4	2.90
4.0	0.70	3.20	51	17.3	5	2.22	4	3.30
5.0	0.80	4.08	51	21.5	5	2.96	4	4.20
6.0	1.00	4.85	51	25.8	5	3.45	4	5.00
8.0	1.25	5.95	75	35.0	6*	4.20	5	6.80
10.0	1.50	7.95	83	43.0	8*	5.85	5	8.50
12.0	1.75	9.95	95	52.0	10*	7.50	5	10.20

ID

ID

175257	175273
167072	167086
167073	167087
167074	167088
167075	167089
167076	167090
175258	175274
175259	175275
175260	175276

*Tol. h6

GW

GW3016



R10

GW3016VS



R10

VS

GW3019



R10

GW3019VS



R10

VS

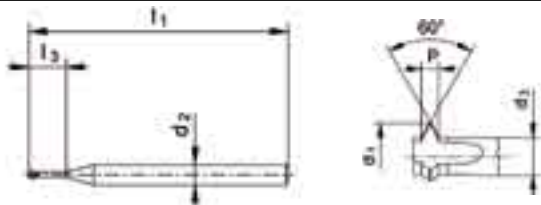

GW3016

GW3016VS

GW3019

GW3019VS



$\varnothing D_1$ UNC	P TPI	d_1 mm	l_1 mm	l_3 mm	d_2 h5 mm	d_3 mm		
2	56	1.66	39	6.1	3	1.02	3	1.75
4	40	2.11	39	8.0	3	1.22	3	2.25
6	32	2.59	51	10.2	5	1.48	4	2.75
8	32	3.25	51	11.9	5	2.14	4	3.40
10	24	3.60	51	14.0	5	2.12	4	3.80
1/4	20	4.89	51	18.2	5	3.11	4	5.10
5/16	18	5.95	63	23.0	6*	3.97	5	6.50
3/8	16	7.10	67	27.0	8*	4.87	5	8.00
1/2	13	9.95	76	36.0	10*	7.21	5	10.80

ID

ID

167472	167500
167473	167501
167474	167502
167475	167503
173983	173986
167476	167504
175232	175246
175233	173546
175234	175247

$\varnothing D_1$ UNC	P TPI	d_1 mm	l_1 mm	l_3 mm	d_2 h5 mm	d_3 mm		
2	56	1.66	39	9.4	3	1.02	3	1.75
4	40	2.11	39	12.2	3	1.22	3	2.25
6	32	2.59	51	15.5	5	1.48	4	2.75
8	32	3.25	51	18.1	5	2.14	4	3.40
10	24	3.60	51	21.3	5	2.12	4	3.80
1/4	20	4.89	51	27.7	5	3.11	4	5.10
5/16	18	5.95	75	35.0	6*	3.97	5	6.50
3/8	16	7.10	83	41.0	8*	4.87	5	8.00
1/2	13	9.95	95	55.0	10*	7.21	5	10.80

ID

ID

167479	167507
167480	167508
167481	167509
167482	167510
173982	173979
167483	167511
175261	175277
175262	175278
175263	175279

*Tol. h6

UNF ANSI B1.1

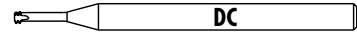

h5

GW

GW3016



GW3016VS



VS

GW3019



GW3019VS



VS

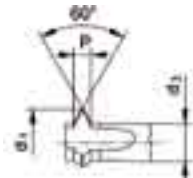
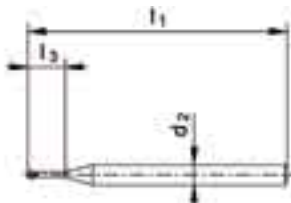

GW3016

GW3016VS

GW3019

GW3019VS



$\varnothing D_1$ UNF	P TPI	d_1 mm	l_1 mm	l_3 mm	d_2 h5 mm	d_3 mm		
0	80	1.15	39	4.3	3	0.71	3	1.20
1	72	1.44	39	5.1	3	0.95	3	1.50
4	48	2.23	39	7.9	3	1.49	3	2.35
8	36	3.35	51	11.7	5	2.36	4	3.50
10	32	3.91	51	13.5	5	2.80	4	4.05
1/4	28	4.95	51	17.6	5	3.68	4	5.50
5/16	24	5.95	63	22.0	6*	4.47	5	6.90
3/8	24	7.10	67	26.0	8*	5.62	5	8.50

ID

ID

$\varnothing D_1$ UNF	P TPI	d_1 mm	l_1 mm	l_3 mm	d_2 h5 mm	d_3 mm		
0	80	1.15	39	6.6	3	0.71	3	1.20
1	72	1.44	39	7.9	3	0.95	3	1.50
4	48	2.23	39	12.1	3	1.49	3	2.35
8	36	3.35	51	18.0	5	2.36	4	3.50
10	32	3.91	51	20.8	5	2.80	4	4.05
1/4	28	4.95	51	27.1	5	3.68	4	5.50
5/16	24	5.95	75	34.0	6*	4.47	5	6.90
3/8	24	7.10	83	40.0	8*	5.62	5	8.50

ID

ID

*Tol. h6

GW

GW

GW4016



R10

GW4016VS



R10

VS

GW4019



R10

GW4019VS



R10

VS

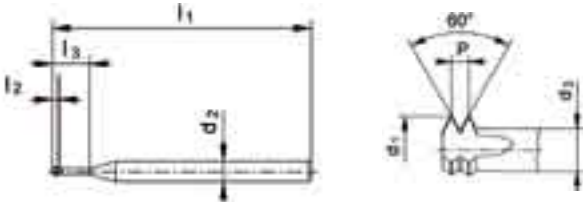

GW4016

GW4016VS

GW4019

GW4019VS



$\varnothing D_1$ M	P mm	d_1 mm	l_1 mm	l_2 mm	l_3 mm	d_2 h5 mm	d_3 mm		
------------------------	---------	-------------	-------------	-------------	-------------	----------------	-------------	--	--

0.8	0.20	0.51	39	0.40	2.3	3	0.23	3	0.58*
0.9	0.225	0.57	39	0.45	2.6	3	0.26	3	0.65*
1.0	0.25	0.64	39	0.50	2.9	3	0.29	3	0.70*
1.2	0.25	0.84	39	0.50	3.4	3	0.49	3	0.90*
1.4	0.30	0.97	39	0.60	4.0	3	0.55	3	1.05*
1.6	0.35	1.09	39	0.70	4.6	3	0.60	3	1.19*
1.8	0.35	1.29	39	0.70	5.1	3	0.80	3	1.39*
2.0	0.40	1.42	39	0.80	5.6	3	0.86	3	1.54*
2.5	0.45	1.85	39	0.90	7.0	3	1.22	3	1.98*
3.0	0.50	2.28	51	1.00	8.5	5	1.58	4	2.43*
3.5	0.60	2.63	51	1.20	10.0	5	1.79	4	2.80*
4.0	0.70	2.99	51	1.40	11.4	5	2.01	4	3.20*
5.0	0.80	3.84	51	1.60	14.1	5	2.72	4	4.10*
6.0	1.00	4.55	51	2.00	17.0	5	3.15	4	4.90*

ID

ID

167105	167119
167106	167120
167107	167121
167108	167122
167109	167123
167110	167124
167111	167125
167112	167126
167113	167127
167114	167128
167115	167129
167116	167130
167117	167131
167118	167132

$\varnothing D_1$ M	P mm	d_1 mm	l_1 mm	l_2 mm	l_3 mm	d_2 h5 mm	d_3 mm		
------------------------	---------	-------------	-------------	-------------	-------------	----------------	-------------	--	--

0.8	0.20	0.51	39	0.40	3.5	3	0.23	3	0.58*
0.9	0.225	0.57	39	0.45	4.0	3	0.26	3	0.65*
1.0	0.25	0.64	39	0.50	4.4	3	0.29	3	0.70*
1.2	0.25	0.84	39	0.50	5.2	3	0.49	3	0.90*
1.4	0.30	0.97	39	0.60	6.1	3	0.55	3	1.05*
1.6	0.35	1.09	39	0.70	7.0	3	0.60	3	1.19*
1.8	0.35	1.29	39	0.70	7.8	3	0.80	3	1.39*
2.0	0.40	1.42	39	0.80	8.6	3	0.86	3	1.54*
2.5	0.45	1.85	39	0.90	10.7	3	1.22	3	1.98*
3.0	0.50	2.28	51	1.00	13.0	5	1.58	4	2.43*
3.5	0.60	2.63	51	1.20	15.2	5	1.79	4	2.80*
4.0	0.70	2.99	51	1.40	17.4	5	2.01	4	3.20*
5.0	0.80	3.84	51	1.60	21.6	5	2.72	4	4.10*
6.0	1.00	4.55	51	2.00	26.0	5	3.15	4	4.90*

ID

ID

167147	167161
167148	167162
167149	167163
167150	167164
167151	167165
167152	167166
167153	167167
167154	167168
167155	167169
167156	167170
167157	167171
167158	167172
167159	167173
167160	167174

*Tol. +0.03 mm
0

UNC-UNF ANSI B1.1

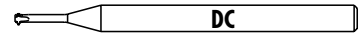

h5

GW

GW4016

GW4016VS

GW4019

GW4019VS

GW4016



GW4016VS



VS

GW4019



GW4019VS



VS

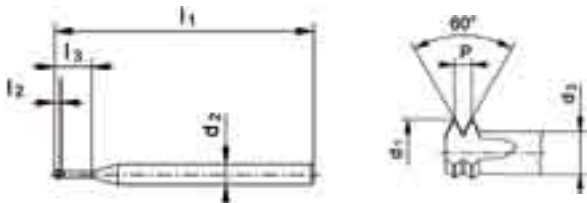

$\varnothing'' D_1$ UNC	P TPI	d_1 mm	l_1 mm	l_2 mm	l_3 mm	d_2 h5 mm	d_3 mm		
2	56	1.52	39	0.91	6.2	3	0.89	3	1.65*
4	40	1.92	39	1.27	8.1	3	1.03	3	2.10*
6	32	2.35	51	1.59	10.4	5	1.24	4	2.60*
1/4	20	4.51	51	2.54	18.5	5	2.73	4	5.00*

ID

ID

167486	167514
167487	167515
167488	167516
167490	167518

$\varnothing'' D_1$ UNF	P TPI	d_1 mm	l_1 mm	l_2 mm	l_3 mm	d_2 h5 mm	d_3 mm		
10	32	3.67	51	1.59	13.7	5	2.56	4	3.95*
1/4	28	4.95	51	1.81	17.7	5	3.68	4	5.35*

ID

ID

167491	167519
167492	167520

$\varnothing'' D_1$ UNC	P TPI	d_1 mm	l_1 mm	l_2 mm	l_3 mm	d_2 h5 mm	d_3 mm		
2	56	1.52	39	0.90	9.5	3	0.89	3	1.65*
4	40	1.92	39	1.27	12.4	3	1.03	3	2.10*
6	32	2.35	51	1.59	15.6	5	1.24	4	2.60*
1/4	20	4.51	51	2.54	28.0	5	2.73	4	5.00*

ID

ID

167493	167521
167494	167522
167495	167523
167497	167525

$\varnothing'' D_1$ UNF	P TPI	d_1 mm	l_1 mm	l_2 mm	l_3 mm	d_2 h5 mm	d_3 mm		
10	32	3.67	51	1.59	20.9	5	2.56	4	3.95*
1/4	28	4.95	51	1.81	27.3	5	3.68	4	5.35*

ID

ID

167498	167526
167499	167527

*Tol. $\begin{matrix} +0.03 \text{ mm} \\ 0 \end{matrix}$

GF - GFH

GF6110



GF6110VS



VS

GFH6110VS



VS

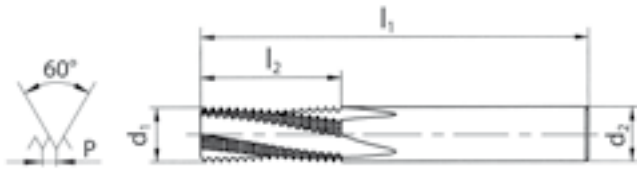

GF6110

GF6110VS

GFH6110VS



HRC
≤ 63



∅ D ₁ M	P mm	d ₁ mm	l ₁ mm	l ₂ mm	d ₂ mm	GF	GFH		ID	ID	ID
2	0.40	1.50	48	3.4	6	2		1.60	125233	115993	
2.5	0.45	1.90	48	4.3	6	3		2.05	150565	152124	
3	0.50	2.30	48	5.3	6	3	3	2.50	125660	116395	150072
3.5	0.60	2.70	48	6.3	6	3		2.90	116350	135217	
4	0.70	3.00	48	7.4	6	3	3	3.30	125944	116396	150073
5	0.80	3.80	48	9.2	6	3	4	4.20	126158	116397	150074
6	1.00	4.50	54	10.5	6		4	5.00			150075
8	1.25	5.95	54	13.1	6		5	6.80			150076
10	1.50	7.95	64	17.3	8		5	8.50			150077
12	1.75	9.95	74	20.1	10		5	10.20			151326



GF

GF6115



GF6115VS



VS

GF6165



GF6165VS



VS

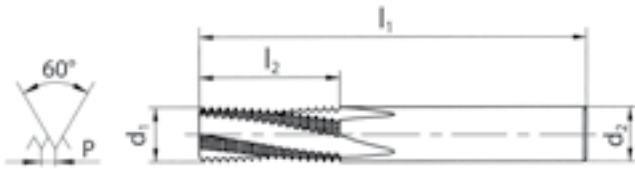

GF6115

GF6115VS

GF6165

GF6165VS



Ø D ₁ M	P mm	d ₁ mm	l ₁ mm	l ₂ mm	d ₂ mm		
4	0.70	3.00	48	8.8	6	3	3.30
5	0.80	3.80	48	10.8	6	3	4.20
6	1.00	4.50	54	13.5	6	3	5.00
8	1.25	5.95	54	18.1	6	3	6.80
10	1.50	7.95	64	21.8	8	4	8.50
12	1.75	9.95	72	25.4	10	4	10.20
14	2.00	9.95	74	31.0	10	4	12.00
16	2.00	11.95	80	35.0	12	4	14.00
18	2.50	13.95	90	41.3	14	4	15.50
20							17.50

ID

ID

ID

ID

146298

146969

146299

146970

146300

146971

126350

116398

146321

146972

126586

116399

146322

146973

124836

116400

116342

116401

125066

116402

125114

115990

125229

116403



GF

GF6116

GF6116VS

VS
GF6166

GF6166VS

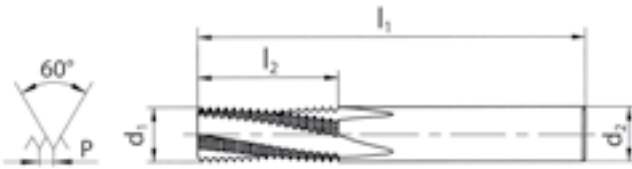
VS

GF6116
GF6116VS
GF6166
GF6166VS

Ø D ₁ M	P mm	d ₁ mm	l ₁ mm	l ₂ mm	d ₂ mm		
4	0.70	3.00	48	10.9	6	3	3.30
5	0.80	3.80	48	13.2	6	3	4.20
6	1.00	4.50	54	16.5	6	3	5.00
8	1.25	5.95	54	21.9	6	3	6.80
10	1.50	7.95	64	26.3	8	4	8.50
12	1.75	9.95	74	32.4	10	4	10.20
14	2.00	9.95	74	37.0	10	4	12.00
16	2.00	11.95	90	43.0	12	4	14.00
18	2.50	13.95	105	53.8	14	4	15.50
20							17.50

ID
ID
ID
ID
155365
155370
155366
155371
155367
155372
155375
155382
155368
155373
155376
155383
155369
155374
155377
155384
155378
155385
155379
155386
155380
155387
155381
155388

GF

GF6110



GF6110VS



GF6110

GF6110VS

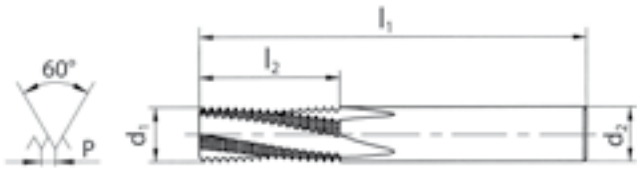

∅ D ₁ MF	P mm	d ₁ mm	l ₁ mm	l ₂ mm	d ₂ mm		
------------------------	---------	----------------------	----------------------	----------------------	----------------------	--	--

4	0.50	3.00	48	7.3	6	3	3.50
5	0.50	3.80	48	8.8	6	3	4.50

ID

ID

135218

135219

135069

135220



GF

GF6165

GF6165VS

GF6166

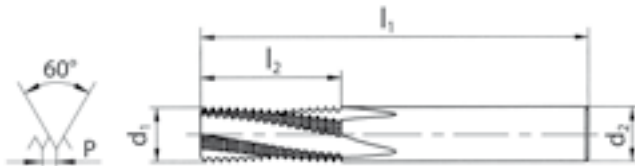
GF6166VS

GF6165
GF6165VS
GF6166
GF6166VS

∅ D ₁ MF	P mm	d ₁ mm	l ₁ mm	l ₂ mm	d ₂ mm		
6	0.50	4.50	54	12.8	6	3	5.50
6	0.75	4.50	54	13.1	6	3	5.25
8	0.50	5.95	54	17.8	6	3	7.50
8	0.75	5.95	54	16.9	6	3	7.25
8	1.00	5.95	54	17.5	6	3	7.00
10	1.00	7.95	64	21.5	8	4	9.00
10	1.25	7.95	64	21.9	8	4	8.80
12	1.00	9.95	72	25.5	10	4	11.00
12	1.50	9.95	72	26.3	10	4	10.50

ID
ID

135221	135222
123664	123665
135002	135223
143110	135224
124239	116404
119986	116405
120102	116406
120303	116407
120392	120393

∅ D ₁ MF	P mm	d ₁ mm	l ₁ mm	l ₂ mm	d ₂ mm		
6	0.50	4.50	54	15.8	6	3	5.50
6	0.75	4.50	54	16.1	6	3	5.25
8	0.50	5.95	54	20.8	6	3	7.50
8	0.75	5.95	54	20.6	6	3	7.25
8	1.00	5.95	54	21.5	6	3	7.00
10	1.00	7.95	64	26.5	8	4	9.00
10	1.25	7.95	64	26.9	8	4	8.80
12	1.00	9.95	74	31.5	10	4	11.00
12	1.50	9.95	74	32.3	10	4	10.50

ID
ID

155389	155398
155390	155399
155391	155400
155392	155401
155393	155402
155394	155403
155395	155404
155396	155405
155397	155406



GF

GF6110



GF6110VS



GF6110

GF6110VS

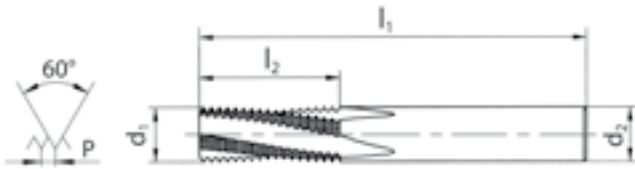

Ø" D ₁ UNC	P TPI	d ₁ mm	l ₁ mm	l ₂ mm	d ₂ mm		
10	24	3.60	48	10.1	6.0	3	3.80
12	24	4.10	48	10.1	6.0	3	4.40
1/4	20	4.80	54	12.1	6.0	3	5.10

ID

ID

135225

135226

135227

135228

135229

135230

GF

GF6165

GF6165VS

GF6166

GF6166VS

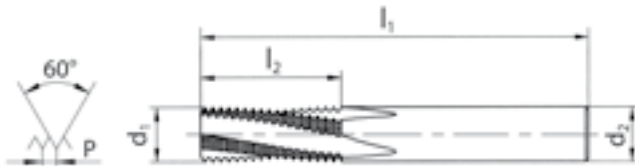
GF6165
GF6165VS
GF6166
GF6166VS

Ø" D ₁ UNC	P TPI	d ₁ mm	l ₁ mm	l ₂ mm	d ₂ mm		
1/4	20	4.80	54	14.6	6.0	3	5.10
5/16	18	5.95	54	17.6	6.0	3	6.50
3/8	16	7.10	64	21.5	8.0	4	8.00
7/16	14	7.95	64	24.5	8.0	4	9.30
1/2	13	9.95	72	28.4	10.0	4	10.80

ID
ID

155407	155408
116047	135231
135232	135233
116049	135234
135235	135236

Ø" D ₁ UNC	P TPI	d ₁ mm	l ₁ mm	l ₂ mm	d ₂ mm		
1/4	20	4.80	54	17.1	6.0	3	5.10
5/16	18	5.95	54	21.9	6.0	3	6.50
3/8	16	7.10	64	26.2	8.0	4	8.00
7/16	14	7.95	64	29.9	8.0	4	9.30
1/2	13	9.95	74	34.2	10.0	4	10.80

ID
ID

155409	155414
155410	155415
155411	155416
155412	155417
155413	155418

UNF ANSI B1.1

VHM
CAR



DIN 6535 HA

HB
HE

sur demande
auf Anfrage
on request
su richiesta
sobre pedido

GF

GF6110



GF6110VS



VS

GF6110

GF6110VS

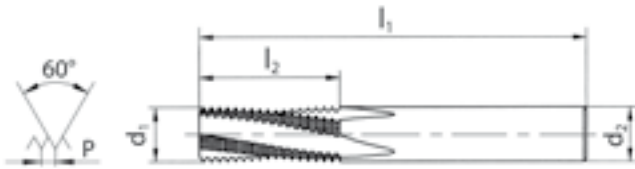

Ø" D ₁ UNF	P TPI	d ₁ mm	l ₁ mm	l ₂ mm	d ₂ mm		
10	32	3.60	48	8.3	6.0	3	4.05
12	28	4.10	48	9.5	6.0	3	4.60
1/4	28	4.80	54	11.3	6.0	3	5.50

ID

ID

128659

135237

135238

135239

135240

135176

GF-GFH-GFS

UNF ANSI B1.1

VHM
CAR



DIN 6535 HA

HB
HE

sur demande
auf Anfrage
on request
su richiesta
sobre pedido

GF

GF6165



GF6165VS



GF6166



GF6166VS



GF6165

GF6165VS

GF6166

GF6166VS

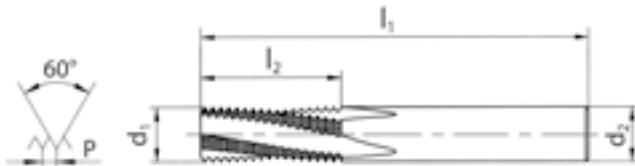

Ø" D ₁ UNF	P TPI	d ₁ mm	l ₁ mm	l ₂ mm	d ₂ mm			ID	ID
1/4	28	4.80	54	14.1	6.0	3	5.50	155419	155420
5/16	24	5.95	54	17.5	6.0	3	6.90	135242	135243
3/8	24	7.10	64	20.6	8.0	4	8.50	135182	135245
7/16	20	7.95	64	24.8	8.0	4	9.80	135246	135247
1/2	20	9.95	72	27.3	10.0	4	11.40	135183	135249

Ø" D ₁ UNF	P TPI	d ₁ mm	l ₁ mm	l ₂ mm	d ₂ mm			ID	ID
1/4	28	4.80	54	16.8	6.0	3	5.50	155421	155426
5/16	24	5.95	54	20.6	6.0	3	6.90	155422	155427
3/8	24	7.10	64	24.9	8.0	4	8.50	155423	155428
7/16	20	7.95	64	28.6	8.0	4	9.80	155424	155429
1/2	20	9.95	74	33.7	10.0	4	11.40	155425	155430

G DIN ISO 228 (BSP)

VHM
CAR



DIN 6535 HA

HB
HE

sur demande
auf Anfrage
on request
su richiesta
sobre pedido

GF

GF6165



GF6165VS



GF6166



GF6166VS



GF6165

GF6165VS

GF6166

GF6166VS

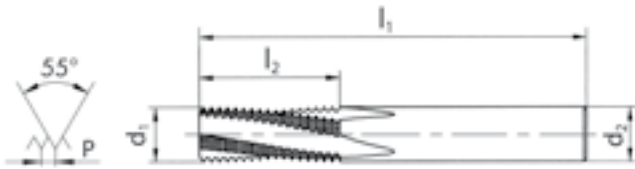
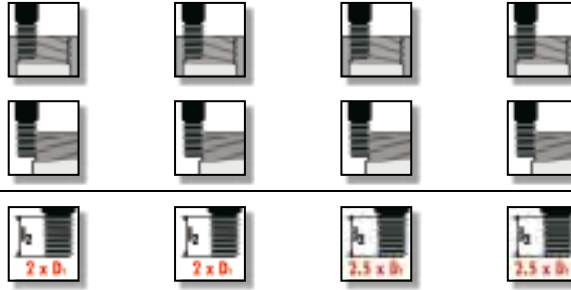

$\varnothing'' D_1$ G	P TPI	d_1 mm	l_1 mm	l_2 mm	d_2 mm		
1/8	28	7.95	64	21.3	8.0	4	8.75
1/4	19	9.95	72	28.7	10.0	4	11.60
3/8	19	13.60	80	35.4	14.0	4	15.20

ID

ID

119347 116409
119292 116410
119678 116411

$\varnothing'' D_1$ G	P TPI	d_1 mm	l_1 mm	l_2 mm	d_2 mm		
1/8	28	7.95	64	24.9	8.0	4	8.75
1/4	19	9.95	74	34.1	10.0	4	11.60
3/8	19	13.60	90	43.4	14.0	4	15.20

ID

ID

155431 155434
155432 155435
155433 155436

GF-GFH-GFS

NPT, NPTF

ANSI B1.20.1
ANSI B1.20.3

VHM
CAR

DIN 6535 HA

HB
HE

sur demande
auf Anfrage
on request
su richiesta
sobre pedido

GF

GF6160



GF6160VS



GF6160

GF6160VS

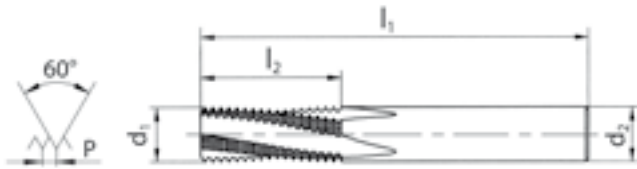

Ø" D ₁ NPT	P TPI	d ₁ mm	l ₁ mm	l ₂ mm	d ₂ mm	♣
1/8	27	7.30	64	9.9	8.0	4
1/4	18	9.95	72	14.8	12.0	4
3/8	18	12.50	80	14.8	14.0	4
1/2	14	14.70	90	19.1	16.0	4

ID

ID

116371	116435
135250	135251
135252	135253
155437	155438

Ø" D ₁ NPTF	P TPI	d ₁ mm	l ₁ mm	l ₂ mm	d ₂ mm	♣
1/8	27	7.30	64	9.9	8.0	4
1/4	18	9.95	72	14.8	12.0	4
3/8	18	12.50	80	14.8	14.0	4
1/2	14	14.70	90	19.1	16.0	4

ID

ID

* 135254	
* 135256	* 135257
* 135258	* 135259
* 155439	* 155440

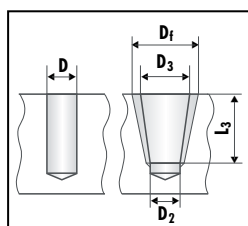

Отверстие под резьбу Średnica otworu				
NPT NPTF				
Ø D ₁	D	D ₂	D ₃ (+0.05)	
1/8	8.5	8.3	8.74	8.76
1/4	11.0	10.8	11.36	11.40
3/8	14.5	14.2	14.80	14.84
1/2	17.9	17.5	18.32	18.33

Фрезерование Frezowanie	
D _f	L ₃
9.81	6.92
12.99	10.02
16.41	10.33
20.37	13.57

GFS

GFS6610



GFS6610VS



GFS6660



GFS6660VS

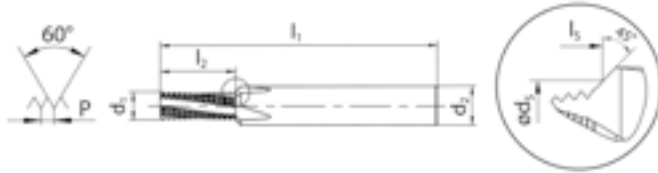

GFS6610



GFS6610VS



GFS6660



GFS6660VS



Ø D ₁ M	P mm	d ₁ mm	l ₁ mm	l ₂ mm	l ₃ mm	d _s mm	d ₂ mm		
2	0.40	1.50	48	3.4	3.7	2.1	6	2	1.60
2.5	0.45	1.90	48	4.3	4.7	2.6	6	3	2.05
3	0.50	2.30	48	5.3	5.6	3.1	6	3	2.50
3.5	0.60	2.70	48	5.7	6.2	3.6	6	3	2.90
4	0.70	3.00	48	7.3	7.9	4.1	6	3	3.30
5	0.80	3.80	54	9.2	9.9	5.1	6	3	4.20
6	1.00	4.50	62	10.5	11.3	6.2	8	3	5.00
8	1.25	5.95	74	13.1	14.3	8.2	10	3	6.80
10	1.50	7.95	80	17.3	18.4	10.3	12	4	8.50
12	1.75	9.95	90	20.1	21.3	12.3	14	4	10.20
14	2.00	10.80	102	25.0	26.8	14.4	16	4	12.00
16	2.00	12.80	102	27.0	28.8	16.4	18	4	14.00
18	2.50	13.95	125	33.8	36.0	18.5	25	4	15.50
20				37.0	20.5				17.50

ID

ID

ID

ID

* 135331

* 135332

* 155441

* 155443

135333

135334

* 155442

* 155444

135335

135336

135337

135338

135339

116175

135340

116172

135341

116173

135342

116174

* 135343

* 135344

135345

135346

* 135347

* 135348

GFS

GFS6615



GFS6615VS



GFS6665



GFS6665VS

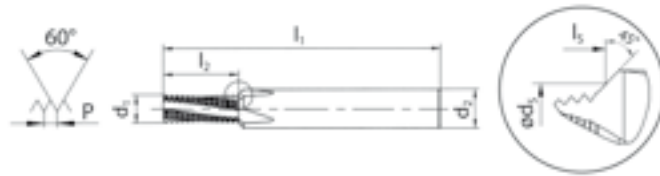

GFS6615

GFS6615VS

GFS6665

GFS6665VS



Ø D ₁ M	P mm	d ₁ mm	l ₁ mm	l ₂ mm	l ₃ mm	d ₅ mm	d ₂ mm		
2	0.40	1.50	48	4.6	4.9	2.1	6	2	1.60
2.5	0.45	1.90	48	5.6	6.0	2.6	6	3	2.05
3	0.50	2.30	48	6.8	7.1	3.1	6	3	2.50
3.5	0.60	2.70	48	7.5	8.0	3.6	6	3	2.90
4	0.70	3.00	48	8.8	9.3	4.1	6	3	3.30
5	0.80	3.80	54	10.8	11.5	5.1	6	3	4.20
6	1.00	4.50	62	13.5	14.3	6.2	8	3	5.00
8	1.25	5.95	74	18.1	19.3	8.2	10	3	6.80
10	1.50	7.95	80	21.8	22.9	10.3	12	4	8.50
12	1.75	9.95	90	25.4	26.6	12.3	14	4	10.20
14	2.00	10.80	102	31.0	32.8	14.4	16	4	12.00
16	2.00	12.80	102	35.0	36.8	16.4	18	4	14.00
18	2.50	13.95	125	41.3	43.5	18.5	25	4	15.50
20					44.5	20.5			17.50

ID

ID

ID

ID

135349

135350

155445

155447

125661

135351

* 155446

* 147108

125946

135352

126160

116178

126352

135353

155524

155525

126587

116343

124837

135354

124973

135355

* 125067

* 135356

125116

135357

* 125231

* 135358

GFS

GFS6616



GFS6616VS



GFS6666



GFS6666VS

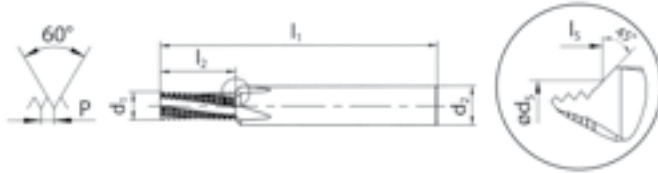

GFS6616

GFS6616VS

GFS6666

GFS6666VS



∅ D ₁ M	P mm	d ₁ mm	l ₁ mm	l ₂ mm	l ₃ mm	d _s mm	d ₂ mm		
3	0.50	2.30	48	8.3	8.7	3.1	6	3	2.50
4	0.70	3.00	48	10.9	11.5	4.1	6	3	3.30
5	0.80	3.80	54	13.2	13.9	5.1	6	3	4.20
6	1.00	4.50	62	16.5	17.4	6.2	8	3	5.00
8	1.25	5.95	74	21.9	23.0	8.2	10	3	6.80
10	1.50	7.95	80	26.3	27.5	10.3	12	4	8.50
12	1.75	9.95	90	32.4	33.6	12.3	14	4	10.20
14	2.00	10.80	102	37.0	38.8	14.4	16	4	12.00
16	2.00	12.80	102	43.0	44.8	16.4	18	4	14.00
18	2.50	13.95	125	53.8	56.1	18.5	25	4	15.50
20					57.1	20.5			17.50

ID

ID

ID

ID

155448

155452

155449

155453

155450

155454

155451

155455

155456

155463

155457

155464

155458

155465

155459

155466

* 155460

* 155467

155461

155468

* 155462

* 155469

GFS

GFS6610



GFS6610VS



GFS6660



GFS6660VS

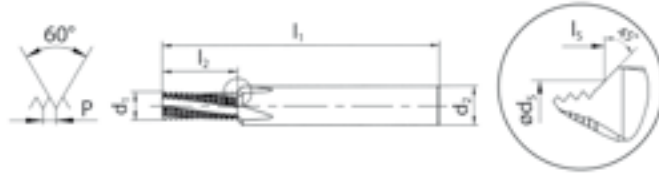

GFS6610

GFS6610VS

GFS6660

GFS6660VS



$\varnothing D_1$ MF	P mm	d_1 mm	l_1 mm	l_2 mm	l_3 mm	d_s mm	d_2 mm			ID	ID	ID	ID
4	0.50	3.00	48	7.3	7.8	4.1	6	3	3.50	135359	135360		
5	0.50	3.80	54	8.8	9.4	5.1	6	3	4.50	135361	135362		
6	0.50	4.50	62	9.8	10.6	6.2	8	3	5.50	135363	135364		
6	0.75	4.50	62	10.1	11.0	6.2	8	3	5.25	135365	135366		
8	0.50	5.95	74	12.8	13.9	8.2	10	3	7.50			135367	135368
8	0.75	5.95	74	13.1	14.3	8.2	10	3	7.25			135369	135370
8	1.00	5.95	74	13.5	14.6	8.2	10	3	7.00			135371	135372
10	1.00	7.95	80	16.5	17.7	10.3	12	4	9.00			135373	135374
10	1.25	7.95	80	16.9	18.1	10.3	12	4	8.80			* 135375	* 135376
12	1.00	9.95	90	19.5	20.7	12.3	14	4	11.00			135377	135378
12	1.50	9.95	90	20.3	21.4	12.3	14	4	10.50			135379	135380
14	1.50	10.80	102	23.3	25.0	14.4	16	4	12.50			135381	135382
16	1.50	12.80	102	26.3	28.1	16.4	18	4	14.50			135383	135384

GFS

GFS6615



GFS6615VS



GFS6665



GFS6665VS

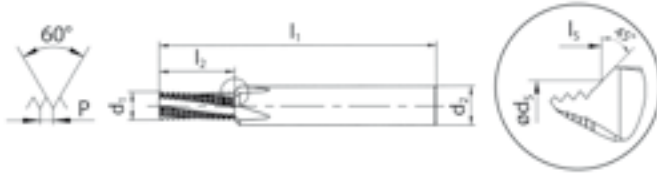

GFS6615



GFS6615VS



GFS6665



GFS6665VS



∅ D ₁ MF	P mm	d ₁ mm	l ₁ mm	l ₂ mm	l ₃ mm	d _s mm	d ₂ mm		
4	0.50	3.00	48	8.8	9.3	4.1	6	3	3.50
5	0.50	3.80	54	10.8	11.4	5.1	6	3	4.50
6	0.50	4.50	62	12.8	13.6	6.2	8	3	5.50
6	0.75	4.50	62	13.1	14.0	6.2	8	3	5.25
8	0.50	5.95	74	17.8	18.9	8.2	10	3	7.50
8	0.75	5.95	74	16.9	18.0	8.2	10	3	7.25
8	1.00	5.95	74	17.5	18.6	8.2	10	3	7.00
10	1.00	7.95	80	21.5	22.7	10.3	12	4	9.00
10	1.25	7.95	80	21.9	23.0	10.3	12	4	8.80
12	1.00	9.95	90	25.5	26.7	12.3	14	4	11.00
12	1.50	9.95	90	26.3	27.4	12.3	14	4	10.50
14	1.50	10.80	102	30.8	32.5	14.4	16	4	12.50
16	1.50	12.80	102	33.8	35.6	16.4	18	4	14.50

ID

ID

ID

ID

135385

135386

135387

135388

135389

135390

135391

135392

135393

135394

135395

135396

135397

135398

135399

135400

135401

135402

135403

135404

135405

135406

135407

135408

135409

135410

GFS

GFS

GFS6610



GFS6610VS



GFS6660



GFS6660VS

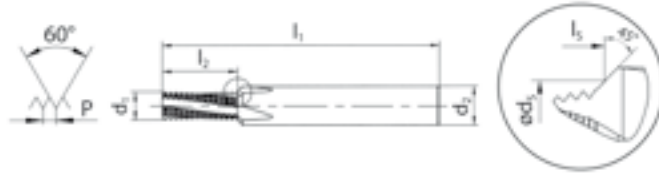

GFS6610

GFS6610VS

GFS6660

GFS6660VS



Ø" D ₁ UNC	P TPI	d ₁ mm	l ₁ mm	l ₂ mm	l ₃ mm	d _s mm	d ₂ mm		
10	24	3.60	54	10.1	10.7	4.9	6	3	3.80
12	24	4.10	54	10.1	10.8	5.6	6	3	4.40
1/4	20	4.80	62	12.1	12.9	6.5	8	3	5.10
5/16	18	5.95	74	14.8	15.9	8.1	10	3	6.50
3/8	16	7.10	80	16.7	18.0	9.8	12	4	8.00
7/16	14	7.95	80	19.0	20.8	11.4	12	4	9.30
1/2	13	9.95	90	22.5	24.0	13.0	14	4	10.80
9/16	12	10.80	102	24.4	26.3	14.6	16	4	12.20
5/8	11	11.90	102	26.5	28.8	16.3	18	4	13.60

ID

ID

ID

ID

* 135420

* 135421

* 135422

* 135423

* 135424

* 135425

* 155470

* 155473

* 135426

* 135427

* 155471

* 155474

* 135428

* 135429

* 155472

* 155475

* 135430

* 135431

* 135432

* 135433

* 135434

* 135435

* 135436

* 135437

GFS

GFS6615



GFS6615VS



GFS6665



GFS6665VS

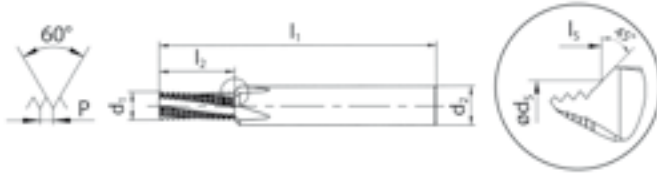

GFS6615



GFS6615VS



GFS6665



GFS6665VS



Ø" D ₁ UNC	P TPI	d ₁ mm	l ₁ mm	l ₂ mm	l ₃ mm	d _s mm	d ₂ mm		
10	24	3.60	54	12.2	12.8	4.9	6	3	3.80
12	24	4.10	54	13.2	14.0	5.6	6	3	4.40
1/4	20	4.80	62	14.6	15.5	6.5	8	3	5.10
5/16	18	5.95	74	17.6	18.7	8.1	10	3	6.50
3/8	16	7.10	80	21.5	22.8	9.8	12	4	8.00
7/16	14	7.95	80	24.5	26.2	11.4	12	4	9.30
1/2	13	9.95	90	28.4	29.9	13.0	14	4	10.80
9/16	12	10.80	102	32.8	34.7	14.6	16	4	12.20
5/8	11	11.90	102	35.8	38.0	16.3	18	4	13.60

ID

ID

ID

ID

* 135438

* 135439

* 135440

* 135441

* 135442

* 135443

* 155476

* 155479

* 135444

* 135445

* 155477

* 155480

* 135446

* 135447

* 155478

* 155481

* 135448

* 135449

* 135450

* 135451

* 135452

* 135453

* 135454

* 135455

GFS

GFS

GFS6610



GFS6610VS



GFS6660



GFS6660VS

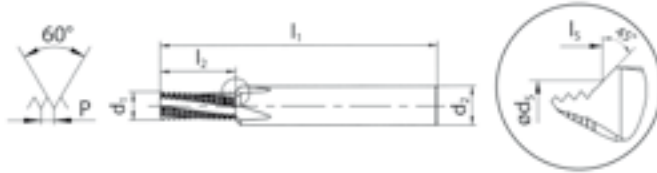

GFS6610

GFS6610VS

GFS6660

GFS6660VS



Ø" D ₁ UNF	P TPI	d ₁ mm	l ₁ mm	l ₂ mm	l ₃ mm	d ₃ mm	d ₂ mm		
10	32	3.60	54	8.3	9.0	4.9	6	3	4.05
12	28	4.10	54	9.5	10.3	5.6	6	3	4.60
1/4	28	4.80	62	11.3	12.2	6.5	8	3	5.50
5/16	24	5.95	74	13.2	14.3	8.1	10	3	6.90
3/8	24	7.10	80	16.4	17.3	9.8	12	4	8.50
7/16	20	7.95	80	18.4	20.1	11.4	12	4	9.80
1/2	20	9.95	90	21.0	22.5	13.0	14	4	11.40
9/16	18	11.60	102	23.3	24.8	14.6	16	4	12.90
5/8	18	11.90	102	26.1	28.3	16.3	18	4	14.50

ID

ID

ID

ID

* 135456

* 135457

* 135458

* 135459

* 135460

* 135461

* 155482

* 155485

* 135462

* 135463

* 155483

* 155486

* 135464

* 135465

* 155484

* 155487

* 135466

* 135467

* 135468

* 135469

* 135470

* 135471

* 135472

* 135473

GFS

GFS6615



GFS6615VS



GFS6665



GFS6665VS

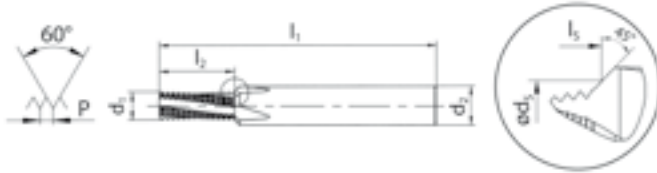

GFS6615

GFS6615VS

GFS6665

GFS6665VS



Ø" D ₁	P	d ₁	l ₁	l ₂	l ₃	d _s	d ₂		
UNF	TPI	mm	mm	mm	mm	mm	mm		

10	32	3.60	54	11.5	12.2	4.9	6	3	4.05
12	28	4.10	54	12.3	13.0	5.6	6	3	4.60
1/4	28	4.80	62	14.1	14.9	6.5	8	3	5.50
5/16	24	5.95	74	17.5	18.6	8.1	10	3	6.90
3/8	24	7.10	80	20.6	21.5	9.8	12	4	8.50
7/16	20	7.95	80	24.8	26.5	11.4	12	4	9.80
1/2	20	9.95	90	27.3	28.8	13.0	14	4	11.40
9/16	18	11.60	102	30.4	31.9	14.6	16	4	12.90
5/8	18	11.90	102	34.6	36.8	16.3	18	4	14.50

ID

ID

ID

ID

128660

135474

* 135475

* 135476

128578

135477

155488

155491

135478

135479

155489

155492

135480

135481

155490

155493

* 135482

* 135483

* 135484

* 135485

* 135486

* 135487

* 135488

* 135489

GFS

G DIN ISO 228 (BSP)

VHM
CAR

DIN 6535 HA

HB
HE

sur demande
auf Anfrage
on request
su richiesta
sobre pedido

GFS

GFS6660



GFS6660VS



GFS6665



GFS6665VS

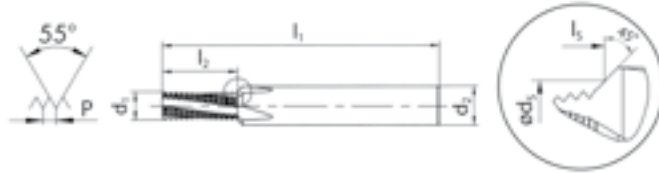

GFS6660



GFS6660VS



GFS6665



GFS6665VS



$\varnothing'' D_1$ G	P TPI	d_1 mm	l_1 mm	l_2 mm	l_3 mm	d_5 mm	d_2 mm		
1/8	28	7.95	80	15.9	16.9	10.0	12	4	8.75
1/4	19	9.95	90	22.1	23.8	13.5	14	4	11.60
3/8	19	12.80	102	27.4	29.5	17.1	18	4	15.20

ID

ID

* 135411

* 135412

* 135413

* 135414

* 135415

* 135416

$\varnothing'' D_1$ G	P TPI	d_1 mm	l_1 mm	l_2 mm	l_3 mm	d_5 mm	d_2 mm		
1/8	28	7.95	80	21.3	22.3	10.0	12	4	8.75
1/4	19	9.95	90	28.7	30.5	13.5	14	4	11.60
3/8	19	12.80	102	35.4	37.6	17.1	18	4	15.20

ID

ID

* 119349

* 135417

* 119298

* 135418

* 119680

* 135419

NPT, NPTF

ANSI B1.20.1
ANSI B1.20.3

VHM
CAR

DIN 6535 HA

HB
HE

sur demande
auf Anfrage
on request
su richiesta
sobre pedido

GFS

GFS6660



GFS6660VS



GFS6660

GFS6660VS

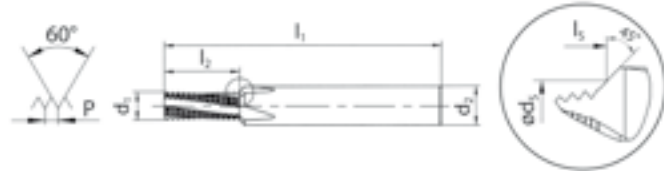

Ø" D ₁ NPT	P TPI	d ₁ mm	l ₁ mm	l ₂ mm	l ₃ mm	d ₅ mm	d ₂ mm	
--------------------------	----------	----------------------	----------------------	----------------------	----------------------	----------------------	----------------------	--

1/8	27	7.30	70	9.9	11.2	10.6	12	4
1/4	18	9.95	80	14.8	16.4	14.0	16	4
3/8	18	12.50	80	14.8	16.9	17.6	18	4

ID

ID

* 126910	* 135490
* 126899	* 135491
* 126928	* 135492

Ø" D ₁ NPTF	P TPI	d ₁ mm	l ₁ mm	l ₂ mm	l ₃ mm	d ₅ mm	d ₂ mm	
---------------------------	----------	----------------------	----------------------	----------------------	----------------------	----------------------	----------------------	--

1/8	27	7.30	70	9.9	11.2	10.6	12	4
1/4	18	9.95	80	14.8	16.4	14.0	16	4
3/8	18	12.50	80	14.8	16.9	17.6	18	4

ID

ID

* 135493	* 135494
* 135495	* 135496
* 135497	* 135498

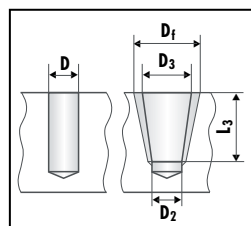

Ø D ₁	Отверстие под резьбу Średnica otworu			
	D	D ₂	NPT NPTF D ₃ (+0.05)	
1/8	8.5	8.3	8.74	8.76
1/4	11.0	10.8	11.36	11.40
3/8	14.5	14.2	14.80	14.84

Фрезерование
Frezowanie

D _f	L ₃
9.81	6.92
12.99	10.02
16.41	10.33

GFM

GFM6260



GFM6260VS



GFM6260

GFM6260VS

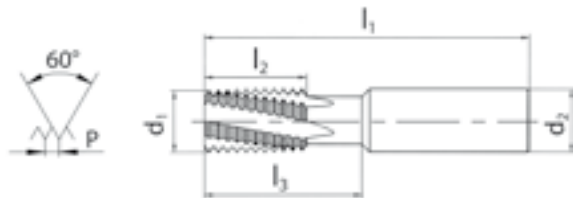

d ₁ mm	P mm	∅ D ₁ ≥ M, MF	l ₁ mm	l ₂ mm	l ₃ mm	d ₂ mm	✚	ID	ID
8	0.50	10	64	16.0	16	8.0	4	116450	135260
8	0.75	10	64	15.8	16	8.0	4	116340	135261
10	0.75	14	70	15.8	26	10.0	4	116128	135262
10	1.00	14	70	16.0	26	10.0	4	118657	135263
10	1.25	14	70	16.3	26	10.0	4	118659	135264
10	1.50	14	70	16.5	26	10.0	4	118661	135265
12	0.50	18	80	20.0	32	12.0	4	116129	135214
12	0.75	18	80	20.3	32	12.0	4	155526	155527
12	1.00	18	80	20.0	32	12.0	4	118664	135007
12	1.50	18	80	21.0	32	12.0	4	118669	135181
12	2.00	18	80	20.0	32	12.0	4	118673	135269
16	1.00	24	90	25.0	42	16.0	4	118680	135270
16	1.50	24	90	25.5	42	16.0	4	118682	116017
16	2.00	24	90	26.0	42	16.0	4	118684	135271
16	2.50	24	90	25.0	42	16.0	4	118689	135272
16	3.00	24	90	27.0	42	16.0	4	158760	150564
20	1.00	30	105	33.0	52	20.0	5	135273	135274
20	1.50	30	105	33.0	52	20.0	5	118694	135275
20	2.00	30	105	34.0	52	20.0	5	116338	135276
20	2.50	30	105	32.5	52	20.0	5	* 135277	
20	3.00	30	105	33.0	52	20.0	5	118699	135279
20	3.50	30	105	38.5	52	20.0	5	144195	144065

GFM

GFM6260



GFM6260VS



GFM6260

GFM6260VS

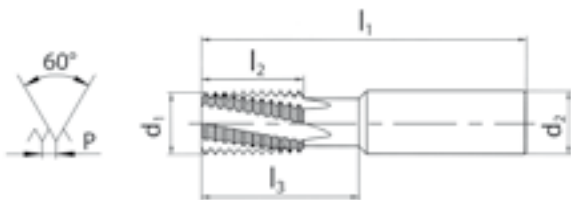

d ₁ mm	P TPI	Ø" D ₁ ≥ UN	l ₁ mm	l ₂ mm	l ₃ mm	d ₂ mm	✂	ID	ID
10	24	1/2	70	15.9	26	10	4	135288	135289
12	24	3/4	80	20.1	32	12	4	135290	135291
12	20	3/4	80	20.3	32	12	4	135292	135293
12	18	3/4	80	19.8	32	12	4	135294	135295
12	16	3/4	80	20.6	32	12	4	135296	135297
12	10	3/4	80	20.3	32	12	4	150963	155494
16	24	1	90	25.4	42	16	4	135298	135299
16	20	1	90	25.4	42	16	4	135300	135301
16	18	1	90	25.4	42	16	4	135302	135303
16	16	1	90	25.4	42	16	4	135304	135305
16	14	1	90	25.4	42	16	4	135306	135307
16	12	1	90	25.4	42	16	4	135308	135309
16	9	1	90	25.4	42	16	4	150964	155495
16	8	1	90	25.4	42	16	4	150965	155496
20	24	1 1/4	105	32.8	52	20	5	* 135310	* 135311
20	20	1 1/4	105	33.0	52	20	5	* 135312	* 135313
20	18	1 1/4	105	32.5	52	20	5	135314	135315
20	16	1 1/4	105	33.4	52	20	5	118697	135316
20	14	1 1/4	105	32.7	52	20	5	135317	135318
20	12	1 1/4	105	31.8	52	20	5	135319	135320
20	8	1 1/4	105	31.8	52	20	5	135321	135322
20	7	1 1/4	105	32.7	52	20	5	150962	155497

GFM

GFM

GFM6260



GFM6260VS



GFM6260

GFM6260VS

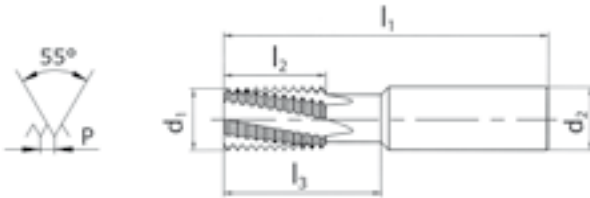

d ₁ mm	P TPI	Ø" D ₁ G	l ₁ mm	l ₂ mm	l ₃ mm	d ₂ mm	
10	19	1/4 - 3/8	70	16.0	26	10	4
16	14	1/2 - 7/8	90	25.4	42	16	4
20	11	≥ 1	105	32.3	52	20	5

ID

ID

118655

135280

118678

135281

118691

135282

NPT, NPTF

ANSI B1.20.1
ANSI B1.20.3

VHM
CAR



DIN 6535 HA

HB
HE

sur demande
auf Anfrage
on request
su richiesta
sobre pedido

GFM

GFM6260



GFM6260VS

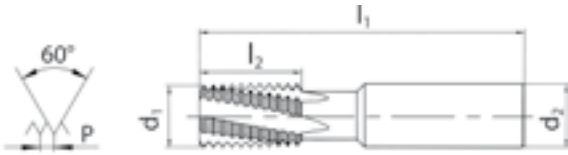

GFM6260

GFM6260VS



d ₁ mm	P TPI	Ø" D ₁ ≥ NPT	l ₁ mm	l ₂ mm	d ₂ mm	
----------------------	----------	----------------------------	----------------------	----------------------	----------------------	--

14.5	14	1/2	90	19.1	16	4
18.5	11.5	1	90	23.2	20	5

ID

ID

135323

135324

135325

135326

d ₁ mm	P TPI	Ø" D ₁ ≥ NPTF	l ₁ mm	l ₂ mm	d ₂ mm	
----------------------	----------	-----------------------------	----------------------	----------------------	----------------------	--

14.5	14	1/2	90	19.1	16	4
18.5	11.5	1	90	23.2	20	5

ID

ID

* 135327

* 135328

* 135329

* 135330

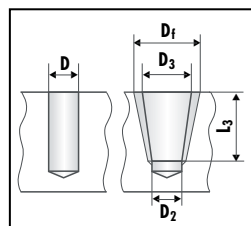

Ø D ₁	Отверстие под резьбу Średnica otworu			
	D	D ₂	NPT D ₃ (+0.05)	NPTF D ₃ (+0.05)
1/2	17.9	17.5	18.32	18.33
3/4	23.2	22.8	23.67	23.68
1	29.0	28.6	29.69	29.72
1 1/4	37.7	37.3	38.45	38.48
1 1/2	44.0	43.5	44.52	44.55
2	56.0	55.5	56.56	56.59

Фрезерование
Frezowanie

D _f	L ₃
20.37	13.57
25.69	14.05
32.18	16.79
40.90	17.30
49.67	17.30
58.99	17.70

GFM

BGF

BGF6760



BGF6760VS



BGF6760

BGF6760VS

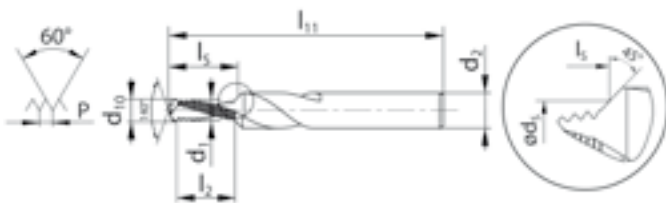

$\varnothing D_1$ M	P mm	d_1 mm	d_{10} mm	l_{11} mm	l_2 mm	l_3 mm	d_5 mm	d_2 mm		ID	ID
4	0.70	3.10	3.30	48	5.6	7.4	4.1	6	2	153400	153415
5	0.80	4.00	4.20	54	7.2	9.4	5.1	6	2	153401	153416
6	1.00	4.75	5.00	62	9.0	11.7	6.2	8	2	153402	153417
8	1.25	6.50	6.75	74	11.2	14.6	8.2	10	2	151911	153418
10	1.50	8.25	8.50	80	14.9	19.1	10.3	12	2	153403	151442
12	1.75	9.95	10.25	90	17.4	22.1	12.3	14	2	153404	153419
14	2.00	11.60	12.00	102	19.9	25.1	14.4	16	2	* 153405	* 153420
16	2.00	13.60	14.00	102	23.9	29.5	16.4	18	2	* 153406	* 153421

BGF

BGF6765



BGF6765VS



BGF6766



BGF6766VS

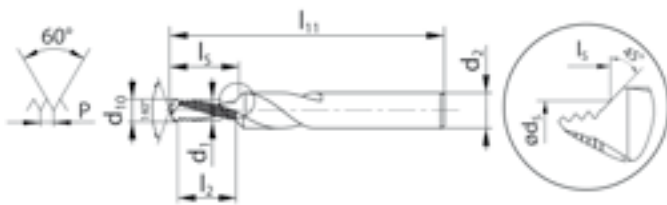

BGF6765

BGF6765VS

BGF6766

BGF6766VS



∅ D ₁ M	P mm	d ₁ mm	d ₁₀ mm	l ₁₁ mm	l ₂ mm	l _s mm	d _s mm	d ₂ mm	
4	0.70	3.10	3.30	48	7.7	9.5	4.1	6	2
5	0.80	4.00	4.20	54	9.6	11.8	5.1	6	2
6	1.00	4.75	5.00	62	12.0	14.7	6.2	8	2
8	1.25	6.50	6.75	74	15.0	18.4	8.2	10	2
10	1.50	8.25	8.50	80	19.4	23.6	10.3	12	2
12	1.75	9.95	10.25	90	22.7	27.3	12.3	14	2
14	2.00	11.60	12.00	102	27.9	33.1	14.4	16	2
16	2.00	13.60	14.00	102	31.9	37.5	16.4	18	2

ID

ID

153430	153442
151305	151306
150933	151776
153431	150588
153432	150589
153433	150927
* 153434	* 153443
* 153435	* 151324

∅ D ₁ M	P mm	d ₁ mm	d ₁₀ mm	l ₁₁ mm	l ₂ mm	l _s mm	d _s mm	d ₂ mm	
6	1.00	4.75	5.00	62	15.0	17.7	6.2	8	2
8	1.25	6.50	6.75	74	20.0	23.4	8.2	10	2
10	1.50	8.25	8.50	80	23.9	28.1	10.3	12	2
12	1.75	9.95	10.25	90	29.7	34.3	12.3	14	2
14	2.00	11.60	12.00	102	35.9	41.1	14.4	16	2
16	2.00	13.60	14.00	102	39.9	45.5	16.4	18	2

ID

ID

153451	153467
153452	153468
153453	153469
153454	153470
* 153455	* 153471
* 153456	* 153472

BGF

BGF6865



BGF6865VS



BGF6866



BGF6866VS

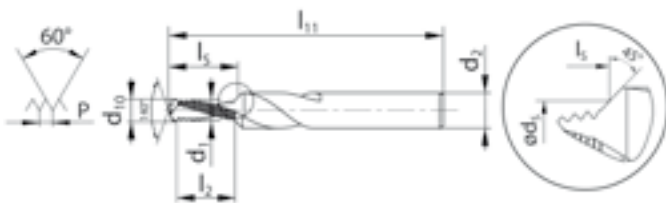

BGF6865

BGF6865VS

BGF6866

BGF6866VS



$\varnothing D_1$ M	P mm	d_1 mm	d_{10} mm	l_{11} mm	l_2 mm	l_3 mm	d_5 mm	d_2 mm	
------------------------	---------	-------------	----------------	----------------	-------------	-------------	-------------	-------------	--

6	1.00	4.75	5.00	62	12.0	14.7	6.2	8	3
8	1.25	6.50	6.75	74	14.9	18.4	8.2	10	3
10	1.50	8.25	8.50	80	19.4	23.6	10.3	12	3
12	1.75	9.95	10.25	90	22.7	27.3	12.3	14	3
14	2.00	11.60	12.00	102	27.9	33.1	14.4	16	3
16	2.00	13.60	14.00	102	31.9	37.5	16.4	18	3

ID

ID

* 153577

* 153589

* 153578

* 153590

* 153579

* 153591

* 153580

* 153592

* 153581

* 153593

* 153582

* 153594

$\varnothing D_1$ M	P mm	d_1 mm	d_{10} mm	l_{11} mm	l_2 mm	l_3 mm	d_5 mm	d_2 mm	
------------------------	---------	-------------	----------------	----------------	-------------	-------------	-------------	-------------	--

6	1.00	4.75	5.00	62	15.0	17.7	6.2	8	3
8	1.25	6.50	6.75	74	20.0	23.4	8.2	10	3
10	1.50	8.25	8.50	80	23.9	28.1	10.3	12	3
12	1.75	9.95	10.25	90	29.7	34.3	12.3	14	3
14	2.00	11.60	12.00	102	35.9	41.1	14.4	16	3
16	2.00	13.60	14.00	102	39.9	45.5	16.4	18	3

ID

ID

* 153601

* 153613

* 153602

* 153614

* 153603

* 153615

* 153604

* 153616

* 153605

* 153617

* 153606

* 153618

BGF

BGF6760



BGF6760VS



BGF6765



BGF6765VS

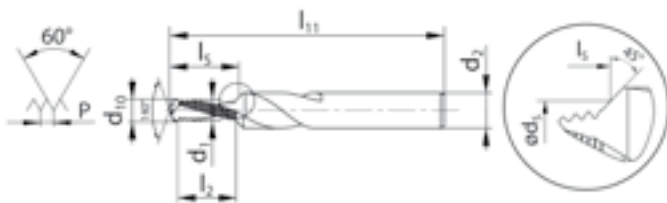

BGF6760



BGF6760VS



BGF6765



BGF6765VS



∅ D ₁ MF	P mm	d ₁ mm	d ₁₀ mm	l ₁₁ mm	l ₂ mm	l _s mm	d _s mm	d ₂ mm	
6	0.75	5.00	5.25	62	9.0	11.4	6.2	8	2
8	1.00	6.75	7.00	74	12.0	15.0	8.2	10	2
10	1.00	8.75	9.00	80	15.0	18.5	10.3	12	2
12	1.00	10.70	11.00	90	18.0	21.9	12.3	14	2
12	1.50	10.20	10.50	90	17.9	22.5	12.3	14	2
14	1.50	12.10	12.50	102	20.9	26.0	14.4	16	2
16	1.50	14.10	14.50	102	23.9	29.4	16.4	18	2







































ID	ID
* 153759	* 153780
* 153761	* 153782
* 153762	* 153783
* 153764	* 153785
* 153765	* 153786
* 153766	* 153787
* 153767	* 153788







∅ D ₁ MF	P mm	d ₁ mm	d ₁₀ mm	l ₁₁ mm	l ₂ mm	l _s mm	d _s mm	d ₂ mm	
6	0.75	5.00	5.25	62	9.0	11.4	6.2	8	2
8	1.00	6.75	7.00	74	12.0	15.0	8.2	10	2
10	1.00	8.75	9.00	80	15.0	18.5	10.3	12	2
12	1.00	10.70	11.00	90	18.0	21.9	12.3	14	2
12	1.50	10.20	10.50	90	17.9	22.5	12.3	14	2
14	1.50	12.10	12.50	102	20.9	26.0	14.4	16	2
16	1.50	14.10	14.50	102	23.9	29.4	16.4	18	2

ID	ID
* 153802	* 153824
* 153804	* 153826
* 153805	* 153827
* 153807	* 153829
* 153808	* 153830
* 153809	* 153831
* 153810	* 153832

















BGF











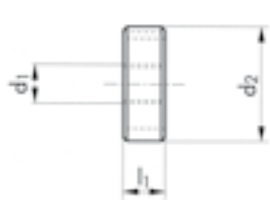



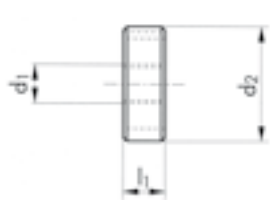

Указатель – Круглые плашки, плашки для Швейцарских автоматов, шестигранные и выгнутые
Skorowidz – Narzynki okrągłe, dla automatyki szwajcarskiej, forma: sześciokątna oraz „dzwonu“

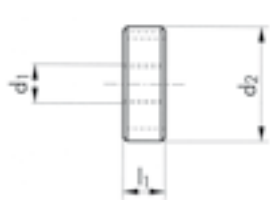
		N		MS	Z		N	Z
Характеристики Cechy charakterystyczne		   	   	   	    	    	   	    
								
		N5110	N5120	MS5120	Z5120	Z5120LL	N5220	Z5220
M 6g	DIN 13	246	246		247	247	260	260
M 6e	DIN 13		246				260	
M 6g LH	DIN 13		246					
MF 6g	DIN 13	248	248-250		248-249		261	
MF 6e	DIN 13		248-249					
MF 6g LH	DIN 13		248-250					
UNC	ANSI B1.1	251	251					
UNF	ANSI B1.1	252	252					
UNEF	ANSI B1.1		253					
UN	ANSI B1.1		253					
UNS	ANSI B1.1		253					
G (BSP)	DIN ISO 228		254	255	255			
G (BSP) LH	DIN ISO 228		254					
G (BSP) -0.1 mm	DIN ISO 228			255				
R (BSPT)	DIN EN 10226		256					
NPT	ANSI B1.20.1		257					
NPTF	ANSI B1.20.3		257					
PG	DIN 40430		258					
TR	DIN 103		258					
W (BSW)	BS 84		259					
W (BSW) LH	BS 84		259					

N	
 	  
	
N5310	N5420
262	263
262	
263	
263	

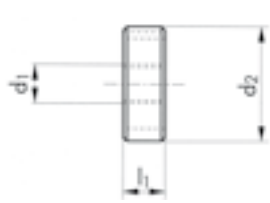
Пиктограммы – Piktogramy

-  Быстрорежущая сталь
HSS
-  Быстрорежущая сталь с кобальтом
HSSE
-  1.25 Заходная часть 1,25 нитки
1.25 zwojów wprowadzających
-  1.75 Заходная часть 1,75 нитки
1.75 zwojów wprowadzających
-  2 Заходная часть 2 нитки
2 zwoje wprowadzające
-  Подчищающая фаска на диаметрах $\varnothing > 3$ mm
Narzynka jednostronna od $\varnothing > 3$ mm
-  Подчищающая фаска с двух сторон на диаметрах $\varnothing > 3$ mm
Narzynka dwustronna od $\varnothing > 3$ mm
-  Количество режущих кромок
Ilość ostrzy
-  Диаметр прутка под плашку
Średnice wałków
-  Азотированные ($d_1 \geq 3$ mm, $P \geq 0.5$ mm)
Azotowany ($d_1 \geq 3$ mm, $P \geq 0.5$ mm)
-  С 2 предохранительными отверстиями
Narzynka z 2 otworami zabezpieczającymi
-  Класс точности 6g
Tolerancja 6g
-  Класс точности 6e
Tolerancja 6e
-  Класс точности Средний
Tolerancja „Średniej Klasy”
-  Класс точности A
Tolerancja A
-  Коническая резьба 1:16 (NPT - NPTF - R)
Gwint stożkowy 1:16 (NPT - NPTF - R)
-  Левая резьба
Gwint lewy

N5110									N5110	N5120	N5120 LH	N5120
  												
  												
  												
  												
$\varnothing d_1$	P	d_2	l_1	\oplus	\oplus	$\rightarrow \ominus \leftarrow$	$\rightarrow \ominus \leftarrow$	ID	ID	ID	ID	\ominus
M	mm	mm	mm	\ominus	LH / $\ominus e$	$\rightarrow \ominus \leftarrow$	$\rightarrow \ominus \leftarrow$					mm
1	0.25	16.0	5.0	3		0.97		103851				
1.1	0.25	16.0	5.0	3		1.07		124659				
1.2	0.25	16.0	5.0	3		1.17		103852				
1.4	0.30	16.0	5.0	3		1.36		103853				
1.6	0.35	16.0	5.0	3		1.54		103855				
1.7	0.35	16.0	5.0	3		1.64		103856				
1.8	0.35	16.0	5.0	3		1.74		103857				
2	0.40	16.0	5.0	3		1.93	1.90	103864				
2.2	0.45	16.0	5.0	3		2.13		103867				
2.3	0.40	16.0	5.0	3		2.23		103869				
2.5	0.45	16.0	5.0	3		2.43	2.40	103872				
2.6	0.45	16.0	5.0	3		2.53		103876				
3	0.50	20.0	5.0	3	4	2.92	2.90	103879	104067	104068	104066	0.030
3.5	0.60	20.0	5.0	3	4	3.41	3.38	103880	104071	104072	* 104070	0.030
4	0.70	20.0	5.0	3	4	3.91	3.87	103881	104114	104115	104113	0.035
4.5	0.75	20.0	7.0	4		4.40		103882	104117			
5	0.80	20.0	7.0	4	4	4.90	4.87	103883	104146	104147	104145	0.035
5.5	0.90	20.0	7.0	4		5.40		103884				
6	1.00	20.0	7.0	4	4	5.88	5.85	103885	104165	104166	104164	0.035
7	1.00	25.0	9.0	4	4	6.88		103886	104174	104175		
8	1.25	25.0	9.0	4	4	7.87	7.83	103887	104186	104187	104185	0.035
9	1.25	25.0	9.0	4		8.87		103888	104191			
10	1.50	30.0	11.0	4	4	9.85	9.82	103858	103953	103954	103952	0.035
12	1.75	38.0	14.0	4	4	11.83	11.80	103859	103973	103974	103972	0.035
14	2.00	38.0	14.0	4	4	13.82		103860	103989	103990		
16	2.00	45.0	18.0	4	4	15.82	15.79		104003	104004	* 104002	0.035
18	2.50	45.0	18.0	5		17.79		* 103862	104015			
20	2.50	45.0	18.0	5	5	19.79		103878	104028	104029		
22	2.50	55.0	22.0	5		21.79			104035			
24	3.00	55.0	22.0	5	5	23.76			104043	104044		
27	3.00	65.0	25.0	5		26.76			104058			
30	3.50	65.0	25.0	5	5	29.73			104079	104080		
33	3.50	65.0	25.0	6		32.73			104089			
36	4.00	65.0	25.0	7		35.70			104100			

≤ M1.4

6h

Z5120		Z5120 LL		Z5120			Z5120 LL		
$\varnothing d_1$ M	P mm	d_2 mm	l_1 mm				ID	ID	
2	0.40	16.0	3.5	4	4	1.93	125269	105115	
2.5	0.45	16.0	5.0	4	4	2.43	104779	105116	
2.6	0.45	16.0	5.0	4		2.53	104780		
3	0.50	20.0	5.0	4	5	2.92	104788	105117	
3.5	0.60	20.0	5.0	4		3.41	104789		
4	0.70	20.0	5.0	4	5	3.91	104790	105118	
5	0.80	20.0	7.0	4	5	4.90	104792	105119	
6	1.00	20.0	7.0	4	5	5.88	104795	105120	
7	1.00	25.0	9.0	4		6.88	111424		
8	1.25	25.0	9.0	5	6	7.87	104798	105121	
10	1.50	30.0	11.0	5	6	9.85	104767	105122	
12	1.75	38.0	14.0	5	6	11.83	104770	105123	
14	2.00	38.0	14.0	5		13.82	104773		
16	2.00	45.0	18.0	5		15.82	104776		
18	2.50	45.0	18.0	5		17.79	104778		
20	2.50	45.0	18.0	5		19.79	104783		
24	3.00	55.0	22.0	6		23.76	104787		

















								N5120	N5120 LH	N5120	Z5120	
N5120				11	12							
N5120 LH		LH		11	12							
N5120				11	12							
Z5120		NI		13	14	21						
								6g	6g	6e	6g	
∅ d ₁ MF	P mm	d ₂ mm	l ₁ mm	N	Z	→ 6g ←	→ 6e ←	ID	ID	ID	6g - mm	ID
* 2	0.25	16.0	5.0	4		1.93		103863				
* 2.5	0.35	16.0	5.0	4		2.44		103871				
3	0.35	20.0	5.0	4		2.94		104064				
3.5	0.35	20.0	5.0	4		3.44		104069				
4	0.35	20.0	5.0	4		3.94		104108				
4	0.50	20.0	5.0	4		3.93		104110				
4.5	0.50	20.0	5.0	4		4.43		104116				
5	0.50	20.0	5.0	4	4	4.93	4.90	104141	104142	104140	0.030	104791
5	0.75	20.0	7.0	4		4.90		104143				
5.5	0.50	20.0	5.0	4		5.43		104148				
6	0.50	20.0	5.0	4		5.93		104159	104160			104793
6	0.75	20.0	7.0	4	4	5.90		104162	104163			104794
7	0.50	25.0	9.0	4	4	6.93		104169				
7	0.75	25.0	9.0	4		6.90	6.87	104171		* 104170	0.035	
8	0.50	25.0	9.0	5		7.93		104177				
8	0.75	25.0	9.0	4	4	7.90		104180				104796
8	1.00	25.0	9.0	4	4	7.88	7.85	104183	104184	104182	0.035	104797
9	0.50	25.0	9.0	5		8.93		104188				
9	0.75	25.0	9.0	5		8.90		104189				
9	1.00	25.0	9.0	5		8.88		104190				
10	0.50	30.0	11.0	5		9.93		103942				
10	0.75	30.0	11.0	5	5	9.90	9.87	103945		* 103944	0.035	104765
10	1.00	30.0	11.0	5	5	9.88	9.85	103948	103949	103947	0.035	104766
10	1.25	30.0	11.0	4		9.86		103950	103951			
11	0.75	30.0	11.0	5		10.90		103956				
11	1.00	30.0	11.0	5		10.88		103957				
11	1.25	30.0	11.0	5		10.87		103958				
12	0.50	38.0	10.0	5		11.93		103960				
12	0.75	38.0	10.0	5		11.90	11.87	103962		* 103961	0.035	
12	1.00	38.0	10.0	5	5	11.88	11.85	103965	103966	103964	0.035	104768
12	1.25	38.0	10.0	4		11.86		103967	103968			
12	1.50	38.0	10.0	4	5	11.85		103970	103971			104769
13	1.00	38.0	10.0	5		12.88		103976				



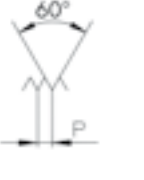
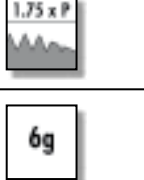

* N5110

P 0.25

6h

N5120		N5120 LH		N5120		Z5120		N5120	N5120 LH	N5120	Z5120	
												
												
$\varnothing d_1$ MF	P mm	d_2 mm	l_1 mm	N	Z	$\rightarrow 6g \leftarrow$	$\rightarrow 6e \leftarrow$	ID	ID	ID	$6g$ - mm	ID
14	0.50	38.0	10.0	5		13.93		103977				
14	0.75	38.0	10.0	5		13.90		103979				
14	1.00	38.0	10.0	5	5	13.88		103981	103982			104771
14	1.25	38.0	10.0	5		13.86		103983				
14	1.50	38.0	10.0	5	5	13.85		103986	103987			104772
15	1.00	38.0	10.0	5		14.88		103991				
15	1.50	38.0	10.0	5		14.85		103992				
16	1.00	45.0	14.0	5	5	15.88	15.85	103996	103997	* 103995	0.035	104774
16	1.25	45.0	14.0	5		15.87		103998				
16	1.50	45.0	14.0	5	5	15.85		104000	104001			104775
17	1.00	45.0	14.0	5		16.88		104005				
18	1.00	45.0	14.0	5		17.88		104008				
18	1.50	45.0	14.0	5	5	17.85		104011	104012			
18	2.00	45.0	14.0	5		17.82		104013				
19	1.00	45.0	14.0	6		18.88		104017				
20	1.00	45.0	14.0	6	6	19.88		104021	104022			104781
20	1.50	45.0	14.0	6	6	19.85		104024	104025			104782
20	2.00	45.0	14.0	6		19.82		104026	* 104027			
21	1.00	45.0	14.0	7		20.88		111386				
22	1.00	55.0	16.0	6		21.88		104030				
22	1.50	55.0	16.0	5	6	21.85		104032				
22	2.00	55.0	16.0	5		21.82		104034				
23	1.00	55.0	16.0	6		22.88		121704				
24	1.00	55.0	16.0	6		23.88		104037				
24	1.50	55.0	16.0	6	6	23.85		104039				
24	2.00	55.0	16.0	6		23.82		104041	104042			
25	1.00	55.0	16.0	6		24.88		104045				
25	1.50	55.0	16.0	6		24.85		104046				
26	1.00	55.0	16.0	7		25.88		104049				
26	1.50	55.0	16.0	6		25.85		104050				
26	2.00	55.0	16.0	6		25.82		104052				
27	1.00	65.0	18.0	6		26.88		104053				
27	1.50	65.0	18.0	6		26.85		104054	* 104055			
27	2.00	65.0	18.0	6		26.82		104056				



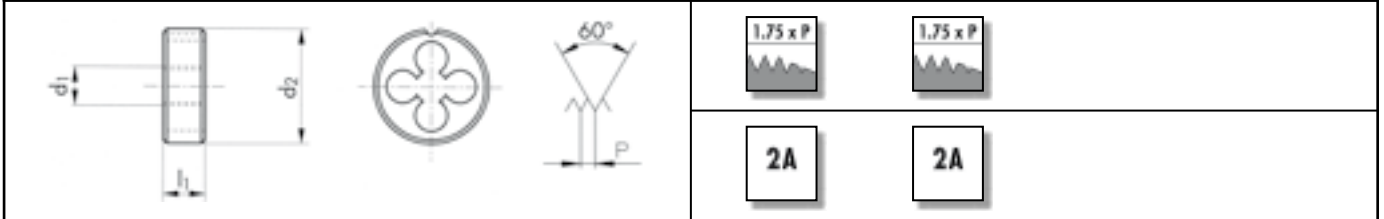

N5120		N5120 LH		N5120		N5120 LH	
$\varnothing d_1$ MF	P mm	d_2 mm	l_1 mm	\oplus	$\rightarrow 6g \leftarrow$	ID	ID
28	1.00	65.0	18.0	6	27.88	104060	
28	1.50	65.0	18.0	6	27.85	104061	
30	1.00	65.0	18.0	7	29.88	104073	
30	1.50	65.0	18.0	6	29.85	104074	
30	2.00	65.0	18.0	6	29.82	104076	
32	1.50	65.0	18.0	7	31.85	104082	* 104083
33	1.50	65.0	18.0	7	32.85	104085	
33	2.00	65.0	18.0	7	32.82	104086	
33	3.00	65.0	25.0	7	32.76	* 104088	
34	1.50	65.0	18.0	7	33.85	104091	
35	1.50	65.0	18.0	8	34.85	104092	* 104093
36	1.50	65.0	18.0	8	35.85	104095	* 104096
36	2.00	65.0	18.0	8	35.82	104097	
36	3.00	65.0	25.0	7	35.76	104099	
38	1.50	75.0	20.0	7	37.85	104101	
39	1.50	75.0	20.0	7	38.85	104104	
40	1.50	75.0	20.0	8	39.85	104118	* 104119
40	2.00	75.0	20.0	7	39.82	104120	
42	1.50	75.0	20.0	8	41.85	104122	
42	3.00	75.0	20.0	8	41.76	104125	
45	1.50	90.0	22.0	7	44.85	104127	
45	2.00	90.0	22.0	7	44.82	104129	
48	1.50	90.0	22.0	8	47.85	104133	* 104134
48	2.00	90.0	22.0	8	47.82	104135	
48	3.00	90.0	22.0	7	47.76	104137	
50	1.50	90.0	22.0	8	49.85	104150	
60	2.00	105.0	22.0	9	59.82	104168	

N5110 N5120		N5110	N5120		
					



Ø" d ₁ UNC	P TPI	d ₂ mm	l ₁ mm	⊕	⚙ →2A←	ID	ID
1	64	16.0	5.0	3	1.79	103893	
2	56	16.0	5.0	4	2.12	103894	
3	48	16.0	5.0	4	2.44	103895	
4	40	16.0	5.0	4	2.76	103896	
5	40	20.0	5.0	4	3.09		104263
6	32	20.0	7.0	4	3.41		104266
8	32	20.0	7.0	4	4.07		104269
10	24	20.0	7.0	4	4.71		104258
12	24	20.0	7.0	4	5.37		104259
1/4	20	20.0	7.0	4	6.22		104256
5/16	18	25.0	9.0	4	7.80		104264
3/8	16	30.0	11.0	4	9.37		104262
7/16	14	30.0	11.0	4	10.95		104267
1/2	13	38.0	14.0	4	12.52		111387
9/16	12	38.0	14.0	4	14.10		104270
5/8	11	45.0	18.0	4	15.68		104265
3/4	10	45.0	18.0	5	18.84		104261
7/8	9	55.0	22.0	5	22.00		104268
1	8	55.0	22.0	5	25.16		104257
1 1/4	7	65.0	25.0	6	31.49		104251
1 1/2	6	75.0	30.0	6	37.81		104250
2	4.5	90.0	36.0	7	50.45		* 104260



N5110							N5110	N5120		
N5120										
										
										
Ø" d ₁ UNF	P TPI	d ₂ mm	l ₁ mm	⊕	⊖	→2A←	ID	ID		
0	80	16.0	5.0	3		1.47	103897			
1	72	16.0	5.0	3		1.79	103898			
2	64	16.0	5.0	4		2.12	103899			
3	56	16.0	5.0	4		2.44	103900			
4	48	16.0	5.0	4		2.77	103901			
5	44	20.0	5.0	4		3.10		104299		
6	40	20.0	5.0	4		3.42		104302		
8	36	20.0	7.0	4		4.08		104305		
10	32	20.0	7.0	4		4.73		104295		
12	28	20.0	7.0	4		5.38		104296		
1/4	28	20.0	7.0	4		6.24		104293		
5/16	24	25.0	9.0	4		7.82		104300		
3/8	24	30.0	11.0	4		9.41		104298		
7/16	20	30.0	11.0	5		10.98		104303		
1/2	20	38.0	10.0	5		12.56		104292		
9/16	18	38.0	10.0	5		14.14		104306		
5/8	18	45.0	14.0	5		15.73		104301		
3/4	16	45.0	14.0	6		18.89		104297		
7/8	14	55.0	16.0	5		22.05		104304		
1	12	55.0	16.0	6		25.21		104294		
1 1/4	12	65.0	18.0	7		31.56		104289		
1 1/2	12	75.0	20.0	7		37.91		111390		

UNEF, UNS, UN













ANSI B1.1

HSS



N5120						N5120
Ø" d ₁ UNEF	P TPI	d ₂ mm	l ₁ mm	⊕	→2A←	ID
12	32	20.0	7.0	4	5.39	104278
1/4	32	20.0	7.0	4	6.25	104275
5/16	32	25.0	9.0	4	7.84	104283
3/8	32	30.0	11.0	4	9.42	104282
7/16	28	30.0	11.0	5	11.00	104285
1/2	28	38.0	10.0	5	12.59	104274
9/16	24	38.0	10.0	5	14.17	104287
5/8	24	45.0	14.0	5	15.75	104284
3/4	20	45.0	14.0	5	18.91	104281
13/16	20	45.0	14.0	6	20.50	* 104279
7/8	20	55.0	16.0	5	22.09	* 104286
1	20	55.0	16.0	6	25.26	* 104276
Ø" d ₁ UNS	P TPI	d ₂ mm	l ₁ mm	⊕	→2A←	ID
1/4	40	20.0	5.0	4	6.26	104309
1/4	36	20.0	5.0	4	6.26	104308
7/16	24	30.0	11.0	5	10.99	104311
1/2	24	38.0	10.0	5	12.58	104307
1	14	55.0	16.0	6	25.23	104310
Ø" d ₁ UN	P TPI	d ₂ mm	l ₁ mm	⊕	→2A←	ID
1 1/8	8	65.0	25.0	5	28.33	104246
1 1/4	8	65.0	25.0	6	31.51	104245
1 1/2	8	75.0	20.0	7	37.85	104244
1 3/4	8	90.0	22.0	7	44.20	104247



						N5120	N5120 LH				
<p>N5120</p>   <p>N5120 LH</p>   						 					
						 					
						 					
\varnothing " d_1	P	d_2	l_1	\oplus	$\rightarrow A \leftarrow$	ID	ID				
G	TPI	mm	mm								
1/8	28	30.0	11.0	5	9.62	103926					
1/4	19	38.0	10.0	5	13.03	103924	103925				
3/8	19	45.0	14.0	5	16.54	103935	103936				
1/2	14	45.0	14.0	6	20.81	103922	103923				
5/8	14	55.0	16.0	5	22.77	103938					
3/4	14	55.0	16.0	6	26.30	103933	103934				
7/8	14	65.0	18.0	6	30.06	103940					
1	11	65.0	18.0	7	33.07	103928					
1 1/4	11	75.0	20.0	8	41.73	103918					
1 3/8	11	90.0	22.0	7	44.14	* 103921					
1 1/2	11	90.0	22.0	8	47.62	103917					
2	11	105.0	22.0	9	59.43	103932					
2 1/2	11	120.0	22.0	10	74.97	103930					

G DIN ISO 228 (BSP)





Z
HSSE

MS
HSS



Z5120		NI		Z5120	MS5120	MS5120	
MS5120							
MS5120							
$\varnothing'' d_1$ G	P TPI	d_2 mm	l_1 mm	\oplus Z	\oplus MS	$\rightarrow A \leftarrow$	ID
1/8	28	30.0	11.0	5	5	9.62	104761 * 101339 * 142831
1/4	19	38.0	10.0	5	5	13.03	104760 101338 * 142832
3/8	19	45.0	14.0	5	5	16.54	104764 101342 119716
1/2	14	45.0	14.0	6	6	20.81	104759 101337 119243
3/4	14	55.0	16.0	6	6	26.30	104763 101341 119648
1	11	65.0	18.0	8	7	33.07	104762 101340 135186
1 1/2	11	90.0	22.0		8	47.62	* 142830



<p>N5120</p>  	<p>N5120</p> 																																																			
																																																				
<table border="1"> <thead> <tr> <th>Ø" d₁</th> <th>P</th> <th>d₂</th> <th>l₁</th> <th>⊕</th> <th>ID</th> </tr> <tr> <th>R</th> <th>TPI</th> <th>mm</th> <th>mm</th> <th></th> <th></th> </tr> </thead> <tbody> <tr> <td>1/8</td> <td>28</td> <td>30.0</td> <td>11.0</td> <td>5</td> <td>104226</td> </tr> <tr> <td>1/4</td> <td>19</td> <td>38.0</td> <td>14.0</td> <td>5</td> <td>104225</td> </tr> <tr> <td>3/8</td> <td>19</td> <td>45.0</td> <td>14.0</td> <td>5</td> <td>104230</td> </tr> <tr> <td>1/2</td> <td>14</td> <td>45.0</td> <td>18.0</td> <td>6</td> <td>104224</td> </tr> <tr> <td>3/4</td> <td>14</td> <td>55.0</td> <td>22.0</td> <td>6</td> <td>104229</td> </tr> <tr> <td>1</td> <td>11</td> <td>65.0</td> <td>25.0</td> <td>7</td> <td>104227</td> </tr> </tbody> </table>	Ø" d ₁	P	d ₂	l ₁	⊕	ID	R	TPI	mm	mm			1/8	28	30.0	11.0	5	104226	1/4	19	38.0	14.0	5	104225	3/8	19	45.0	14.0	5	104230	1/2	14	45.0	18.0	6	104224	3/4	14	55.0	22.0	6	104229	1	11	65.0	25.0	7	104227				
Ø" d ₁	P	d ₂	l ₁	⊕	ID																																															
R	TPI	mm	mm																																																	
1/8	28	30.0	11.0	5	104226																																															
1/4	19	38.0	14.0	5	104225																																															
3/8	19	45.0	14.0	5	104230																																															
1/2	14	45.0	18.0	6	104224																																															
3/4	14	55.0	22.0	6	104229																																															
1	11	65.0	25.0	7	104227																																															

Размеры диаметров под резьбу R (в мм)

Wymiary wałków pod gwinty typu R (w mm)

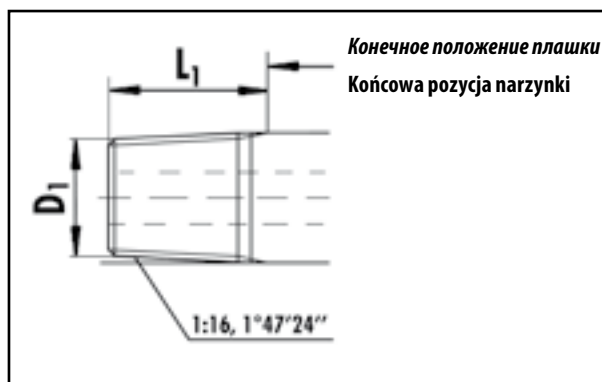

Ø" R	D ₁ mini mm	D ₁ maxi mm	D ₁ (guide line) mm	L ₁ (guide line) mm
1/8	9.422	9.534	9.48	8.2
1/4	12.700	12.863	12.78	12.1
3/8	16.181	16.343	16.26	12.5
1/2	20.330	20.555	20.44	16.4
3/4	25.735	25.960	25.85	17.7
1	32.455	32.743	32.60	20.9

N5120						
N5120						
$\varnothing'' d_1$ NPT, NPTF	P TPI	d_2 mm	l_1 mm	\oplus	ID	ID
1/16	27	25.0	9.0	4	104194	
1/8	27	30.0	11.0	5	104197	* 104207
1/4	18	38.0	14.0	5	104196	
3/8	18	45.0	14.0	5	104201	
1/2	14	45.0	18.0	6	104195	* 104205
3/4	14	55.0	22.0	6	104200	
1	11.5	65.0	25.0	7	104198	* 104208
1 1/4	11.5	75.0	26.0	8	104193	

Размеры диаметров под резьбы NPT и NPTF (в мм)

Wymiary wałków pod gwinty typu NPT oraz NPTF (w mm)

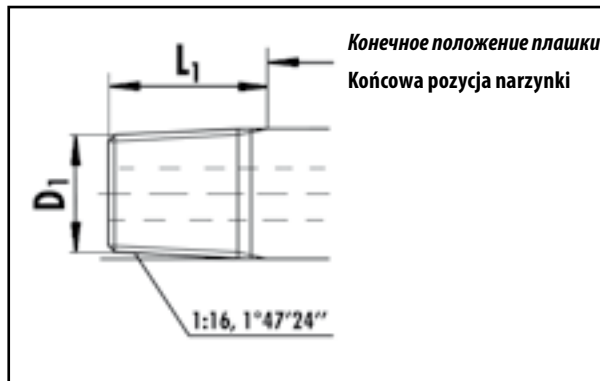

\varnothing'' NPT	D_1 mini mm	D_1 maxi mm	D_1 (guide line) mm	L_1 (guide line) mm	\varnothing'' NPTF	D_1 mini mm	D_1 maxi mm	D_1 (guide line) mm	L_1 (guide line) mm
1/16	7.521	7.643	7.58	8.4	1/16	7.525	7.617	7.57	8.4
1/8	9.866	9.988	9.93	8.5	1/8	9.870	9.962	9.92	8.5
1/4	13.099	13.255	13.18	12.7	1/4	13.129	13.215	13.17	12.7
3/8	16.518	16.674	16.60	12.9	3/8	16.548	16.634	16.59	12.9
1/2	20.551	20.713	20.63	16.8	1/2	20.617	20.703	20.66	16.8
3/4	25.866	26.028	25.95	17.1	3/4	25.932	26.018	25.98	17.1
1	32.419	32.591	32.51	21.3	1	32.475	32.561	32.52	21.3
1 1/4	41.144	41.316	41.23	21.9					

N5120			N5120	N5120		
N5120			PG	TR		

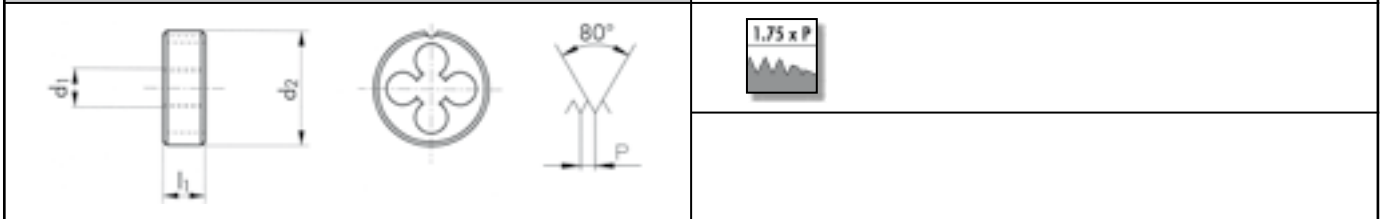

$\varnothing d_1$ PG	P TPI	d_2 mm	l_1 mm			ID
7	20	38.0	10.0	5	12.40	104220
9	18	38.0	10.0	5	15.10	104221
11	18	45.0	14.0	5	18.50	104212
13.5	18	45.0	14.0	6	20.30	104213
16	18	55.0	16.0	5	22.40	104214
21	16	65.0	18.0	6	28.15	* 104215
29	16	65.0	18.0	8	36.85	* 104216
36	16	90.0	22.0	8	46.85	* 104217
42	16	90.0	22.0	10	53.85	* 104218
48	16	105.0	22.0	9	59.15	* 104219

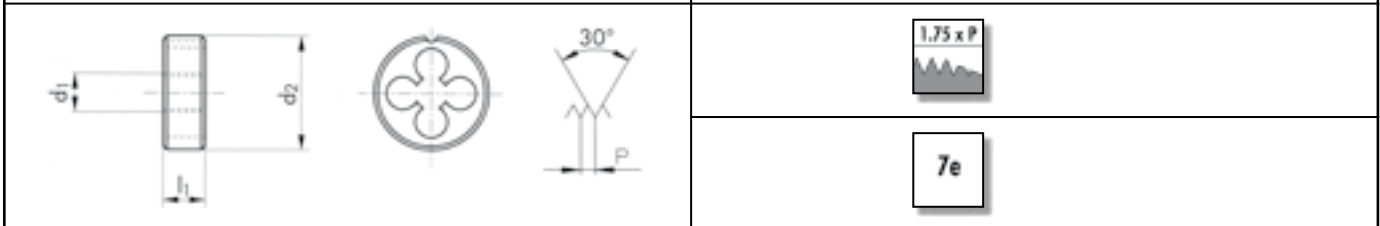

$\varnothing d_1$ TR	P mm	d_2 mm	l_1 mm			ID
*10	2	38.0	14.0	4	9.91	* 104231
12	3	38.0	14.0	4	11.88	* 104232
16	4	45.0	18.0	4	15.85	* 104234
26	5	65.0	25.0	5	25.83	* 104239
28	5	65.0	25.0	5	27.83	* 104240
32	6	65.0	25.0	6	31.81	* 104242
36	6	65.0	25.0	6	35.81	* 104243



N5120		N5120 LH		N5120		N5120 LH	

								N5220	N5220	Z5220	
N5220											
N5220											
Z5220			NI								
$\varnothing d_1$ M	P mm	d_2 mm	l_1 mm	\oplus	TK mm	$\rightarrow 6g \leftarrow$	$\rightarrow 6e \leftarrow$	ID	ID $6g$ - mm	ID	
1.4	0.30	16.0	2.6	4	12.2	1.36		104346			
1.6	0.35	16.0	2.6	4	12.2	1.54		104347			
1.7	0.35	16.0	2.6	4	12.2	1.64		* 104348			
2	0.40	16.0	3.5	4	12.2	1.93	1.90	104367			
2.3	0.40	16.0	3.5	4	12.2	2.23		104369			
2.5	0.45	16.0	3.5	4	12.2	2.43	2.40	104371	* 104370 0.030	104803	
2.6	0.45	16.0	3.5	4	12.2	2.53		104372			
3	0.50	16.0	3.5	4	12.2	2.92	2.90	104375	104374 0.030	104804	
3.5	0.60	16.0	4.0	4	12.2	3.41		104376			
4	0.70	16.0	5.0	4	12.2	3.91	3.87	104380	104379 0.035	104805	
5	0.80	20.0	7.0	4	15.0	4.90	4.87	104384	104383 0.035	104806	
6	1.00	20.0	7.0	4	15.0	5.88	5.85	104388	104387 0.035	104807	
7	1.00	25.0	7.0	4	19.0	6.88		* 104392			
8	1.25	25.0	9.0	4	19.0	7.87	7.83	104397	104396 0.035	104808	
10	1.50	30.0	11.0	6	23.0	9.85	9.82	104354	104353 0.035		
12	1.75	30.0	11.0	6	23.0	11.83		104358			

≤ M1.4

6h

N5220							N5220			
$\varnothing d_1$	P	d_2	l_1	\oplus	TK	$\rightarrow \leftarrow$	ID			
MF	mm	mm	mm		mm					
3	0.35	16.0	3.0	4	12.2	2.94	104373			
4	0.35	16.0	3.5	4	12.2	3.94	* 104377			
4	0.50	16.0	4.0	4	12.2	3.93	104378			
5	0.50	20.0	5.0	4	15.0	4.93	104382			
6	0.50	20.0	5.0	4	15.0	5.93	104385			
6	0.75	20.0	7.0	4	15.0	5.90	104386			
7	0.50	25.0	7.0	4	19.0	6.93	* 104389			
7	0.75	25.0	7.0	4	19.0	6.90	* 104390			
8	0.75	25.0	7.0	4	19.0	7.90	* 104394			
8	1.00	25.0	7.0	4	19.0	7.88	* 104395			
10	0.75	30.0	7.0	6	23.0	9.90	* 104350			
10	1.00	30.0	7.0	6	23.0	9.88	* 104351			
10	1.25	25.0	9.0	6	19.0	9.86	* 104352			
12	1.00	30.0	7.0	6	23.0	11.88	* 104355			
12	1.50	30.0	11.0	6	23.0	11.85	* 104356			
14	1.00	35.0	10.0	6	27.5	13.88	* 104359			
14	1.50	35.0	10.0	6	27.5	13.85	* 104360			



N5310						N5310	
$\varnothing d_1$ M	P mm	s mm	l_1 mm			ID	
3	0.50	18.0	5.0	3	2.92	104464	
3.5	0.60	18.0	5.0	3	3.41	* 104465	
4	0.70	18.0	5.0	3	3.91	104478	
4.5	0.75	18.0	7.0	3	4.41	* 104479	
5	0.80	18.0	7.0	4	4.90	104487	
6	1.00	18.0	7.0	4	5.88	104493	
7	1.00	21.0	9.0	4	6.88	* 104497	
8	1.25	21.0	9.0	4	7.87	104502	
9	1.25	21.0	9.0	5	8.87	* 104503	
10	1.50	27.0	11.0	4	9.85	104438	
12	1.75	36.0	14.0	4	11.83	104443	
14	2.00	36.0	14.0	4	13.82	104445	
16	2.00	41.0	18.0	4	15.82	104447	
18	2.50	41.0	18.0	5	17.79	104450	
20	2.50	41.0	18.0	5	19.79	104453	
22	2.50	50.0	22.0	5	21.79	104456	
24	3.00	50.0	22.0	5	23.76	104459	
27	3.00	60.0	25.0	5	26.76	* 104463	
30	3.50	60.0	25.0	5	29.73	104468	
52	5.00	85.0	36.0	8	51.66	* 104489	
$\varnothing d_1$ MF	P mm	s mm	l_1 mm			ID	
6	0.75	18.0	7.0	4	5.90	* 104492	
8	0.75	21.0	9.0	4	7.90	* 104500	
8	1.00	21.0	9.0	4	7.88	* 104501	
12	1.00	36.0	10.0	4	11.88	* 104440	
20	1.50	41.0	14.0	6	19.85	* 104451	
27	1.50	60.0	18.0	6	26.85	* 104461	
27	2.00	60.0	18.0	6	26.82	* 104462	
30	2.00	60.0	18.0	6	29.82	* 104467	
33	1.50	60.0	18.0	7	32.85	* 104469	
33	2.00	60.0	18.0	7	32.82	* 104470	
38	1.50	70.0	20.0	8	37.85	* 104475	
39	1.50	70.0	20.0	8	38.85	* 104476	
40	1.50	70.0	20.0	8	39.85	* 104480	
64	2.00	115.0	22.0	8	63.82	* 104495	

N5310		N5310	N5310	N5420
N5310				
N5420				

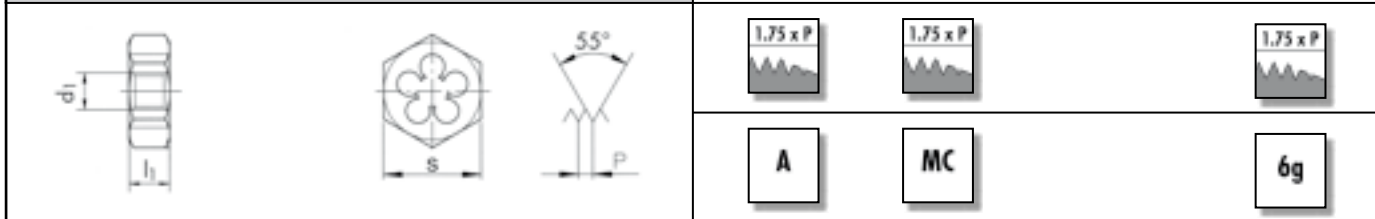

$\varnothing'' d_1$ G	P TPI	s mm	l_1 mm	\oplus	$\rightarrow \leftarrow$	ID
1/4	19	36.0	10.0	5	13.03	104428
3/8	19	41.0	14.0	5	16.54	104433
1/2	14	41.0	14.0	6	20.81	104427
5/8	14	50.0	16.0	6	22.77	* 104434
3/4	14	50.0	16.0	6	26.30	104432
7/8	14	60.0	18.0	6	30.06	* 104435
1	11	60.0	18.0	7	33.07	104430
1 3/8	11	85.0	22.0	7	44.14	* 104426
1 3/4	11	100.0	22.0	8	53.57	* 104425

$\varnothing'' d_1$ W	P TPI	s mm	l_1 mm	\oplus	$\rightarrow \leftarrow$	ID
1/8	40	18.0	5.0	3	3.09	* 104512
3/16	24	18.0	7.0	3	4.66	* 104515
7/16	14	27.0	11.0	5	10.98	* 104520
9/16	12	36.0	14.0	4	14.14	* 104522
7/8	9	50.0	22.0	5	22.10	* 104521
1 3/8	6	60.0	25.0	6	34.77	* 104508
1 1/2	6	70.0	30.0	6	37.95	* 104504
1 3/4	5	85.0	36.0	6	44.28	* 104507
2	4.5	85.0	36.0	7	50.63	* 104514

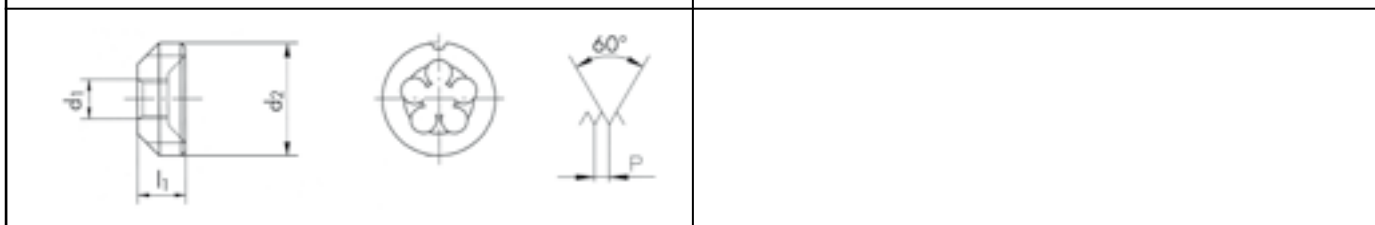

$\varnothing d_1$ M	P mm	d_2 mm	l_1 mm	\oplus	$\rightarrow \leftarrow$	ID
2.5	0.45	16.0	8.0	4	2.43	* 104527
3.5	0.60	16.0	9.5	4	3.41	* 104530
4	0.70	16.0	9.5	4	3.90	* 104531
8	1.25	25.0	14.0	5	7.86	* 104535

Указатель – резьбовые калибры пробки и кольца
Skorowidz – Sprawdziany tłoczkowe oraz pierścieniowe

Характеристики Charakterystyki								
								
		D5701-1	D5701-2	D5703		D5720	D5722	D5725
M 6H / 6g	ISO DIN 13	266	266	266				
M 6G / 6e	ISO DIN 13			266				
M 6H / 6g LH	ISO DIN 13			266				
MF 6H / 6g	ISO DIN 13	268-269	269	268-269				
MF 6G / 6e	ISO DIN 13			268				
MF 6H / 6g LH	ISO DIN 13			268				
UNC	ANSI B1.1	272		272				
UNF	ANSI B1.1	273		273				
UNEF	ANSI B1.1			273				
NPT	ANSI B1.20.1					275		
NPTF	ANSI B1.20.3					275		
G (BSP)	DIN ISO 228	274	274	274				
PG	DIN 40430							274
EG M	ISO DIN 8140			276				
EG UNC	NASM 33537			276				
EG UNF	NASM 33537			276				

D5704	D5714	D5721	D5723
267	267		
267	267		
267			
270-271	270-271		
270			
272	272		
273	273		
273	273		
		275	
		275	
274	274		
274			

Пиктограммы – Piktogramy



„ПР“
„Go“ - przechodni



„HE“
„No-go“ - nieprzechodni



„ПР“ / „HE“
„Go“ / „No-go“ - przechodni/nieprzechodni



Класс точности 6H „ПР“
Tolerancja 6H „Go“ - przechodni



Класс точности 6H „ПР“ / „HE“
Tolerancja 6G „Go“ / „No-go“ - przechodni/nieprzechodni



















Класс точности 6H „HE“
Tolerancja 6g „No-go“ - nieprzechodni









Левая резьба
Gwint lewy









		D5701-1	D5701-2	D5703	D5703 LH	D5703	
D5701-1 M1 - M1.4 =  D5703 M1 - M1.4 = 							
					 LH		
∅ d ₁ M	P mm	ID	ID	ID	ID	ID	
1	0.25			100242			
1.1	0.25			100243			
1.2	0.25			100244			
1.4	0.30			100245			
1.6	0.35			100246	* 110168		
1.7	0.35			100247			
1.8	0.35			100248	* 110169		
2	0.40			100278	105159	104982	
2.2	0.45			100280			
2.3	0.40			100281			
2.5	0.45			100283	105160	104979	
2.6	0.45	* 100064		100285			
3	0.50			100310	104964	104976	
3.5	0.60			100312		104977	
4	0.70			100333	104966	104978	
4.5	0.75	* 100114					
5	0.80			100348	104967	104980	
6	1.00			100363	104968	104981	
7	1.00			100369	* 110186		
8	1.25			100373	104969	104983	
9	1.25			100375			
10	1.50			100253	104970	104984	
11	1.50			* 100256			
12	1.75			100261	104971	104985	
14	2.00	* 100045		100266		104986	
16	2.00			100271	104973	104987	
18	2.50	* 100055		100276		* 104988	
20	2.50	* 100068		100289	104975	104989	
22	2.50	* 100072		100293	* 110178		
24	3.00	* 100076		100297	110179		
27	3.00			100305	* 110180		
30	3.50			100316			
33	3.50	* 100101		100322			
36	4.00	* 100107		100328			
39	4.00	* 100109		100330			
42	4.50	100119	142843				
45	4.50	100122	142844				
48	5.00	100125	142845				
52	5.00	100132	142846				
56	5.50	100137	142847				





		D5704	D5704 LH	D5704	D5714	D5714	
D5704 M1 - M1.4 =  D5714 M1 - M1.4 = 							
			 LH				
Ø d ₁ M	P mm	ID	ID	ID	ID	ID	
1	0.25	100480			110419		
1.2	0.25	100481			110420		
1.4	0.30	100482			110421		
1.6	0.35	100483			110422		
1.7	0.35	100484			111439		
1.8	0.35	100485			110423		
2	0.40	100515	105006	* 104997	100734	* 142833	
2.2	0.45	100517			100735		
2.3	0.40	100518			100736		
2.5	0.45	100520		* 104991	100737	* 142834	
2.6	0.45	100522			100738		
3	0.50	100547	105001	* 104990	100763	* 142835	
3.5	0.60	100549	110302	* 110301	100765	* 142836	
4	0.70	100570	105003	* 104992	100774	* 142837	
5	0.80	100585	105004	* 104993	100778	* 143406	
6	1.00	100600	105005	* 104994	100781	* 135556	
7	1.00	100605	* 126560	* 104995	100783	* 142840	
8	1.25	100611	105007	* 104996	100786	* 142841	
9	1.25	100610			100788		
10	1.50	100490	105008	* 104998	100711	* 142842	
11	1.50	* 100493			* 100713		
12	1.75	100498	105009		100718		
14	2.00	100503	105010		100723		
16	2.00	100508	105011	* 105000	100728		
18	2.50	100513	105012		100733		
20	2.50	100526	105013		100742		
22	2.50	100530	110298		100746		
24	3.00	100534			100750		
27	3.00	100542			100758		
30	3.50	100553			100769		
33	3.50	* 100559			* 100770		
36	4.00		* 110305				
39	4.00				* 110440		
42	4.50	* 100577					
45	4.50	* 100580			* 110448		
48	5.00				* 110451		
52	5.00	* 100590			* 110456		
56	5.50	* 100595			* 110461		





		D5701-1	D5703	D5703 LH	D5703		
							
				 			
$\varnothing d_1$ MF	P mm	ID	ID	ID	ID		
2.5	0.35		100282				
3	0.35		100309				
4	0.35		100331				
4	0.50		100332				
4.5	0.50		* 100334				
5	0.50		100347	105016	105045		
6	0.50	* 100140	100361	110184			
6	0.75		100362		105046		
7	0.50		100367				
7	0.75	* 100147	100368				
8	0.50	* 100149	100370				
8	0.75		100371	105018	105047		
8	1.00	* 100151	100372	105019	105048		
9	1.00		100374				
10	0.50		100249				
10	0.75		100250				
10	1.00		100251	105020	105049		
10	1.25	* 100031	100252				
11	0.75	* 100033					
11	1.00	* 100034	100255				
12	0.75	* 100036	100257				
12	1.00		100258	105021	105050		
12	1.25		100259				
12	1.50	* 100039	100260	105022			
14	1.00		100263	110171			
14	1.25		100264				
14	1.50	* 100044	100265	105023	105052		
15	1.00	* 100046	100267				
15	1.50		100268				
16	1.00		100269	110172			
16	1.50	* 100049	100270	105024	105053		
17	1.00		100272				
18	1.00		100273				
18	1.50	* 100053	100274	105025	105054		
18	2.00	* 100054	100275				
20	1.00	* 100065	100286				
20	1.50		100287	105026			
20	2.00	* 100067	100288		* 110176		
22	1.00		100290				
22	1.50		100291	110177			
22	2.00		100292				
24	1.00		100294				
24	1.50		100295				
24	2.00		100296				

		D5701-1	D5701-2	D5703			
							
							
$\varnothing d_1$ MF	P mm	ID	ID	ID			
25	1.00	* 100077		100298			
25	1.50			100299			
25	2.00			100300			
26	1.00			100301			
26	1.50	* 100081		100302			
27	1.50	* 100082		100303			
27	2.00	* 100083		100304			
28	1.00			100306			
28	1.50	* 100086		100307			
28	2.00	* 100087		100308			
30	1.00	* 100092		100313			
30	1.50			100314			
30	2.00			100315			
32	1.00			100317			
32	1.50	* 100097		100318			
32	2.00			100319			
33	1.50			100320			
33	2.00	* 100100		100321			
35	1.50	* 100102		100323			
36	1.50	* 100104		100325			
36	2.00			100326			
36	3.00			100327			
38	1.50	* 100108		100329			
40	1.50			100336			
40	2.00			100337			
42	1.50	100117	142848				
42	2.00	100118	142849				
45	1.50	100120	110127				
45	2.00	100121	142851				
48	1.50	100123	123180				
48	2.00	100124	142853				
50	1.50	100128	142854				
50	2.00	100129	142855				
52	1.50	100130	123428				
52	2.00	100131	142857				
55	1.50	100133	123468				
55	2.00	100134	142859				
56	1.50	100135	142860				
56	2.00	100136	142861				
58	1.50	100138	142862				
58	2.00	100139	142863				
60	1.50	100143	142864				
60	2.00	100144	142865				











		D5704	D5704 LH	D5714			
							
							
$\varnothing d_1$ MF	P mm	ID	ID	ID			
2.5	0.35	100519		110427			
3	0.35	100546		100762			
3.5	0.35	100548		100764			
4	0.35	100568		100772			
4	0.50	100569		100773			
4.5	0.50	100571		100775			
5	0.50	100584	105057	100777			
6	0.50	100598	110307	100779			
6	0.75	100599	105058	100780			
7	0.50	100603		110467			
7	0.75	100604		100782			
8	0.50	100606		* 110468			
8	0.75	100607	* 105059	100784			
8	1.00	100608	105060	100785			
9	1.00	100609		100787			
10	0.50	100486		100707			
10	0.75	100487		100708			
10	1.00	100488	105061	100709			
10	1.25	100489		100710			
11	1.00	100492		100712			
12	0.75	100494		100714			
12	1.00	100495	105062	100715			
12	1.25	100496		100716			
12	1.50	100497	105063	100717			
13	1.00	100499		100719			
14	1.00	100500	110290	100720			
14	1.25	100501		100721			
14	1.50	100502	105064	100722			
15	1.00	100504		100724			
15	1.50	100505		100725			
16	1.00	100506	110292	100726			
16	1.50	100507	105065	100727			
17	1.00	100509		100729			
18	1.00	100510		100730			
18	1.50	100511	105066	100731			
20	1.00	100523	110295	100739			
20	1.50	100524	105067	100740			
20	2.00	100525		100741			
22	1.00	100527		100743			
22	1.50	100528		100744			
22	2.00	100529		100745			
24	1.00	100531		100747			
24	1.50	100532		100748			
24	2.00	100533					

		D5704	D5714				
							
							
Ø d ₁ MF	P mm	ID	ID				
25	1.00	100535					
25	1.50	100536					
26	1.00	100538	* 100754				
26	1.50	100539	* 100755				
27	1.50	100540	* 100756				
27	2.00	100541	* 100757				
28	1.00	100543					
28	1.50	100544	* 100760				
30	1.00	100550					
30	1.50	100551					
30	2.00	100552	* 100768				
32	1.00	100554					
32	1.50	100555					
32	2.00	100556	* 110431				
33	1.50	100557	* 110432				
33	2.00	100558	* 110433				
35	1.50	100560					
36	1.50	100562					
36	2.00	100563					
36	3.00	100564					
38	1.50	100566	* 110439				
40	1.50	100573	* 110441				
42	1.50	100575					
42	2.00	100576					
45	1.50	100578					
45	2.00	100579	* 110447				
48	1.50	100581	* 110449				
48	2.00	100582					
50	1.50	100586	* 110452				
50	2.00	100587	* 110453				
52	1.50		* 110454				
52	2.00	100589					
55	1.50	100591					
55	2.00	100592	* 110458				
56	1.50	100593	* 110459				
56	2.00	100594	* 110460				
58	1.50	100596					
58	2.00	100597	* 110463				
60	1.50	100601	* 110464				
60	2.00	105014					



UNC









ANSI B1.1
ANSI B1.2

		D5701-1	D5703	D5704	D5714		
							
							
Ø" d ₁ UNC	P TPI	ID	ID	ID	ID		
1	64		100408	110347	110473		
2	56	* 110076	100414	110353	110479		
3	48	* 110077	100416		* 110480		
4	40	* 110080	110224	110357	110483		
5	40		100420	* 110358	* 110484		
6	32	* 110084	100423	110361	110487		
8	32	* 110087	100426	110364	110490		
10	24	* 110074	100412	110351	110477		
12	24		100413				
1/4	20		100410	110349	110475		
5/16	18	* 110082	100421	110359	110485		
3/8	16	* 110079	100418	110356	110482		
7/16	14	* 110085	100424	110362	110488		
1/2	13	* 110071	100409	110348	110474		
9/16	12		100427	110365	* 110491		
5/8	11	* 110083	100422	110360			
3/4	10	* 110078	100417	110355	* 110481		
7/8	9		100425	110363	* 110489		
1	8	* 110073	100411	110350	* 110476		
1 1/8	7	* 110068	100405	* 110345	* 110471		
1 1/4	7	* 110067	100404	* 110344	* 110470		
1 3/8	6	* 110069	100407	* 110346	* 110472		
1 1/2	6	* 110066	100403	* 110343	* 110469		













UNF, UNEF

ANSI B1.1

ANSI B1.2

		D5701-1	D5703	D5704	D5714		
							
							
Ø" d ₁ UNF	P TPI	ID	ID	ID	ID		
0	80		110246	* 110378	* 110503		
1	72	* 110105	110251	110383	110508		
2	64		110256	110389	110514		
3	56	* 110112	110257	110390	110515		
4	48		110260	110393	110518		
5	44	* 110116	* 110261				
6	40		110264	110397	110522		
8	36	* 110122	110267	* 110400			
10	32		110254	110387	110512		
12	28		110255	110388	110513		
1/4	28	* 110107	110006	110385	110510		
5/16	24	* 110117	110262	110395	110520		
3/8	24	* 110114	110259	110392	110517		
7/16	20	* 110120	110265	110398	111440		
1/2	20	* 110106	110252	110384	110509		
9/16	18		110268	110401			
5/8	18	* 110118	110263	110396			
3/4	16		110258	110391	* 110516		
7/8	14		110266	110399			
1	12		128646	110386			
1 1/8	12	* 110103	110249	110381	* 110506		
1 1/4	12	* 110102	110248	110380	* 110505		
1 3/8	12	* 110104	110250	* 110382	* 110507		
1 1/2	12		110247	110379			
Ø" d ₁ UNEF	P TPI	ID	ID	ID	ID		
12	32		110238	* 110370	* 110495		
1/4	32		110236	110368	110493		
5/16	32		110241	110373	110498		
3/8	32		110240	110372	110497		
7/16	28		110243	110375	110500		
1/2	28		110235	110367	110492		
9/16	24		110245	110377	110502		
5/8	24		110242	110374	110499		
3/4	20		110239	110371	110496		
7/8	20		110244		* 110501		
1	20		110253	110369	110494		



		D5701-1	D5701-2	D5703	D5704	D5714	D5725
							
							
\varnothing " d ₁ G	P TPI	ID	ID	ID	ID	ID	
1/8	28	* 110044		110009	110277	110408	
1/4	19			110003	110276	110407	
3/8	19	* 110052		110162	110284	110415	
1/2	14			110001	110275	110406	
5/8	14			110164	110286	110417	
3/4	14			110161	110283	110414	
7/8	14	* 110054		110165	* 110287	* 110418	
1	11			110156	110278	110409	
1 1/8	11			110154		* 110404	
1 1/4	11	110041	119459		110272		
1 1/2	11	110040	119429		110271		
1 3/4	11	110043	142868		110274	* 110405	
2	11	110050	110126		110282		
2 1/4	11					* 110411	
2 1/2	11		* 110125				
2 3/4	11					* 110412	
3	11				* 110285	* 110416	
\varnothing d ₁ PG	P TPI	ID				ID	ID
7	20						110216
9	18						110217
11	18						110205
13.5	18						110209
16	18					* 110330	110210
21	16					* 110331	110211
29	16					* 110332	110212

NPT, NPTF

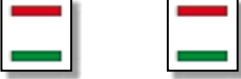

ANSI B1.20.1 / ANSI B1.20.3

ANSI B1.20.1 / ANSI B1.20.5

		D5720	D5721				
							
							
\varnothing " d ₁ NPT	P TPI	ID	ID				
1/16	27	110190	110313				
1/8	27	110193	110316				
1/4	18	110192	110315				
3/8	18	110197	110320				
1/2	14	110191	110314				
3/4	14	110196	110319				
1	11.5	110194	110317				
1 1/4	11.5	110189	110312				
1 1/2	11.5	110188	110311				
2	11.5	110195	110318				
\varnothing " d ₁ NPTF	P TPI	ID	ID				
1/8	27	110201	* 110324				
1/4	18	110200	* 110323				
3/8	18	110204	* 110327				
1/2	14	110199	* 110322				
3/4	14	110203	* 110326				
1	11.5	110202	* 110325				



EG M ISO DIN 8140 ISO DIN 1502 EG UNC, EG UNF NASM 33537









		D5703	D5703	D5703			
							
							
$\varnothing d_1$ EG M	P mm	ID					
2.5	0.45	110132					
3	0.50	110133					
4	0.70	110134					
5	0.80	110135					
6	1.00	110136					
8	1.25	110137					
10	1.50	110128					
12	1.75	110129					
16	2.00	110131					
\varnothing " d ₁ EG UNC	P TPI	ID					
4	40	170252					
6	32	170253					
8	32	170254					
10	24	170255					
1/4	20	170256					
5/16	18	170257					
3/8	16	170258					
\varnothing " d ₁ EG UNF	P TPI	ID					
6	40	170259					
8	36	170260					
10	32	161020					
1/4	28	151790					
5/16	24	170261					
3/8	24	160134					

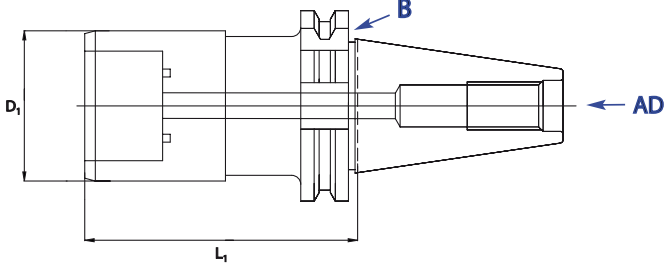



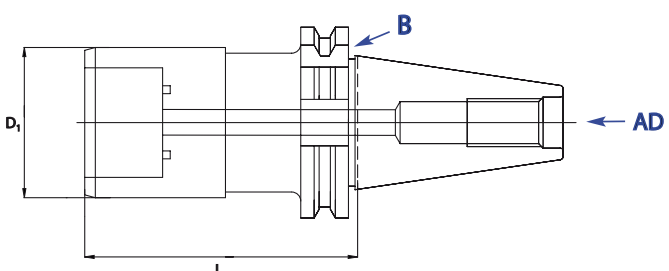

SYNCHRO



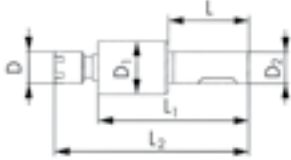
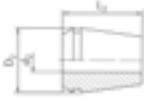

DIN 69 871 Form AD + B					SRT-SK40-312	SRT-SK40-520	SRT-SK40-1433
<h1>SK</h1>							
							
  282					ID	ID	ID
M3 - M12	36	65.0	SK 40	S1	170124		
M5 - M20	53	79.0	SK 40	S2		170125	
M14 - M33	78	115.0	SK 40	S3			170126
DIN 69 871 Form AD + B					SRT-SK50-520	SRT-SK50-1433	SRT-SK50-2248
<h1>SK</h1>							
							
  282					ID	ID	ID
M5 - M20	53	79.0	SK 50	S2	170128		
M14 - M33	78	115.0	SK 50	S3		170129	
M22 - M48	96	170.0	SK 50	S4			170130

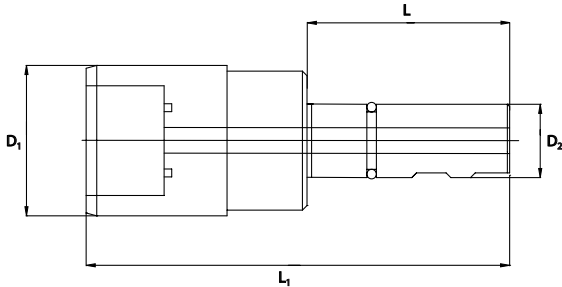













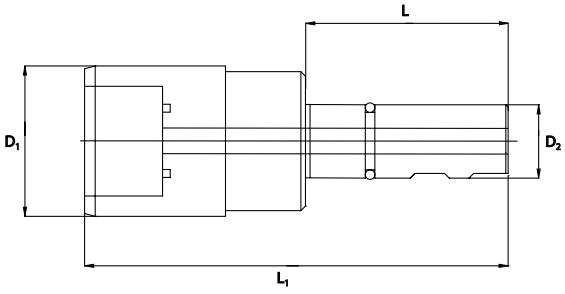









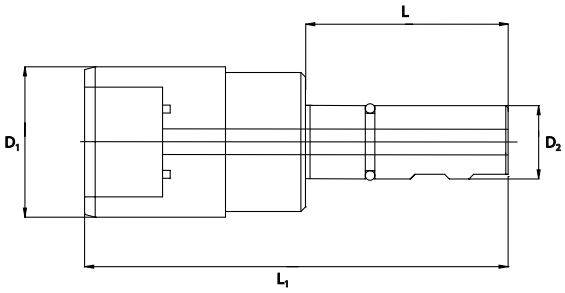

DIN 1835 B	SRT032-D6	SRT054-D12	ER8	
				
SRT032 / SRT054		D9865-		
				
	D mm	D ₁ mm	D ₂ mm	
	L mm	L ₁ mm	L ₂ mm	
M0.3 - M2	12	11	6	
M0.5 - M4	12	20	12	
	25	40	56.0	
	33	59	75.0	
	ID	ID		
	157610	127413		
No	D ₂ mm	L ₃ mm	d ₂ mm	
ER8-0200	8.5	13.5	2.0	
ER8-0250	8.5	13.5	2.5	
ER8-0300	8.5	13.5	3.0	
ER8-0350	8.5	13.5	3.5	
ER8-0400	8.5	13.5	4.0	
ER8-0450	8.5	13.5	4.5	
				ID
				118895
				118896
				118897
				118898
				118899
				118900
DIN 1835 B	SRT312-D20	SRT312-D25	SRT520-D25	
				
				
	D ₁ mm	D ₂ mm	L mm	
	L ₁ mm			
M3 - M12	39	20	47	
M3 - M12	39	25	53	
M5 - M20	56	25	53	
	86.0			
	90.0			
	110.0			
				
			282	
	ID	ID	ID	
	162832	162831		
			162833	

SRT Резьбовые патроны с осевой компенсацией



Oprawki SRT wyposażone w kompensację osiową



Uniquement pour taraudage synchrone
Nur für Synchrobearbeitung
Only for rigid tapping
Solo per maschiatura sincrona
Solo para roscado sincronizado

DIN 1835 B	SRT-1D20-312	SRT-1D25-312	SRT-2D25-520																												
SRT																															
	 <50 bar	 <50 bar	 <50 bar																												
<table border="1"> <thead> <tr> <th></th> <th>D₁ mm</th> <th>D₂ mm</th> <th>L mm</th> <th>L₁ mm</th> <th></th> <th> 282</th> </tr> </thead> <tbody> <tr> <td>M3 - M12</td> <td>36</td> <td>20</td> <td>51.0</td> <td>97</td> <td>S1</td> <td></td> </tr> <tr> <td>M3 - M12</td> <td>36</td> <td>25</td> <td>57.0</td> <td>103</td> <td>S1</td> <td></td> </tr> <tr> <td>M5 - M20</td> <td>53</td> <td>25</td> <td>57.0</td> <td>131</td> <td>S2</td> <td></td> </tr> </tbody> </table>		D ₁ mm	D ₂ mm	L mm	L ₁ mm		 282	M3 - M12	36	20	51.0	97	S1		M3 - M12	36	25	57.0	103	S1		M5 - M20	53	25	57.0	131	S2		ID 170140	ID 170020	ID 170141
	D ₁ mm	D ₂ mm	L mm	L ₁ mm		 282																									
M3 - M12	36	20	51.0	97	S1																										
M3 - M12	36	25	57.0	103	S1																										
M5 - M20	53	25	57.0	131	S2																										
DIN 1835 B	SRT-2D32-520	SRT-3D25-1433	SRT-3D32-1433																												
SRT																															
	 <50 bar	 <50 bar	 <50 bar																												
<table border="1"> <thead> <tr> <th></th> <th>D₁ mm</th> <th>D₂ mm</th> <th>L mm</th> <th>L₁ mm</th> <th></th> <th> 282</th> </tr> </thead> <tbody> <tr> <td>M5 - M20</td> <td>53</td> <td>32</td> <td>61.5</td> <td>135.5</td> <td>S2</td> <td></td> </tr> <tr> <td>M14 - M33</td> <td>78</td> <td>25</td> <td>57.0</td> <td>164.5</td> <td>S3</td> <td></td> </tr> <tr> <td>M14 - M33</td> <td>78</td> <td>32</td> <td>61.5</td> <td>169.0</td> <td>S3</td> <td></td> </tr> </tbody> </table>		D ₁ mm	D ₂ mm	L mm	L ₁ mm		 282	M5 - M20	53	32	61.5	135.5	S2		M14 - M33	78	25	57.0	164.5	S3		M14 - M33	78	32	61.5	169.0	S3		ID 170142	ID 170143	ID 170144
	D ₁ mm	D ₂ mm	L mm	L ₁ mm		 282																									
M5 - M20	53	32	61.5	135.5	S2																										
M14 - M33	78	25	57.0	164.5	S3																										
M14 - M33	78	32	61.5	169.0	S3																										

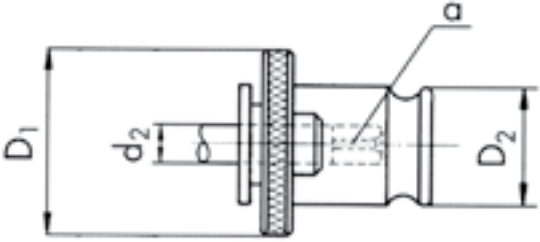

SRT					S1-	S2-	S3-	S4-
								
No	D ₁ mm	D ₂ mm	d ₂ mm	α mm	ID	ID	ID	ID
S1-0028	30	19.0	2.8	2.1	129915			
S1-0035	30	19.0	3.5	2.7	129916			
S1-0045	30	19.0	4.5	3.4	129918			
S1-0060	30	19.0	6.0	4.9	129920			
S1-0070	30	19.0	7.0	5.5	129921			
S1-0080	30	19.0	8.0	6.2	129922			
S1-0090	30	19.0	9.0	7.0	129923			
S1-0100	30	19.0	10.0	8.0	129924			
S1-0110	30	19.0	11.0	9.0	129925			
S2-0060	48	31.0	6.0	4.9		129927		
S2-0070	48	31.0	7.0	5.5		129928		
S2-0080	48	31.0	8.0	6.2		129929		
S2-0090	48	31.0	9.0	7.0		129930		
S2-0100	48	31.0	10.0	8.0		129931		
S2-0110	48	31.0	11.0	9.0		148303		
S2-0120	48	31.0	12.0	9.0		129932		
S2-0140	48	31.0	14.0	11.0		129933		
S2-0160	48	31.0	16.0	12.0		129934		
S2-0180	48	31.0	18.0	14.5		151355		
S3-0110	70	48.0	11.0	9.0			170145	
S3-0120	70	48.0	12.0	9.0			170146	
S3-0140	70	48.0	14.0	11.0			170147	
S3-0160	70	48.0	16.0	12.0			170148	
S3-0180	70	48.0	18.0	14.5			170149	
S3-0200	70	48.0	20.0	16.0			170150	
S3-0220	70	48.0	22.0	18.0			170151	
S3-0250	70	48.0	25.0	20.0			170152	
S4-0180	96	60.0	18.0	14.5				170153
S4-0200	96	60.0	20.0	16.0				170154
S4-0220	96	60.0	22.0	18.0				170155
S4-0250	96	60.0	25.0	20.0				170156
S4-0280	96	60.0	28.0	22.0				170157
S4-0320	96	60.0	32.0	24.0				170158
S4-0360	96	60.0	36.0	29.0				170159

CLASSIC

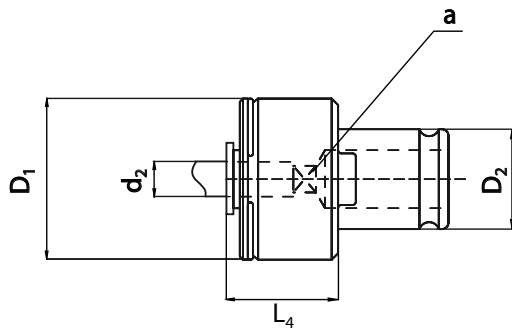

SC1-

SC2-

SC3-

SC4-



No	D ₁ mm	D ₂ mm	d ₂ mm	a mm	L ₄ mm	ID	ID	ID	ID
SC1-0028	32	19.0	2.8	2.1	25	170160			
SC1-0035	32	19.0	3.5	2.7	25	170161			
SC1-0045	32	19.0	4.5	3.4	25	170162			
SC1-0060	32	19.0	6.0	4.9	25	170163			
SC1-0070	32	19.0	7.0	5.5	25	170164			
SC1-0080	32	19.0	8.0	6.2	25	170165			
SC1-0090	32	19.0	9.0	7.0	25	170166			
SC1-0100	32	19.0	10.0	8.0	25	170167			
SC2-0060	50	31.0	6.0	4.9	34		170168		
SC2-0070	50	31.0	7.0	5.5	34		170169		
SC2-0080	50	31.0	8.0	6.2	34		170170		
SC2-0090	50	31.0	9.0	7.0	34		170171		
SC2-0100	50	31.0	10.0	8.0	34		170172		
SC2-0110	50	31.0	11.0	9.0	34		170173		
SC2-0120	50	31.0	12.0	9.0	34		170174		
SC2-0140	50	31.0	14.0	11.0	34		170175		
SC2-0160	50	31.0	16.0	12.0	34		170176		
SC2-0180	50	31.0	18.0	14.5	34		170177		
SC3-0110	72	48.0	11.0	9.0	45			170178	
SC3-0120	72	48.0	12.0	9.0	45			170179	
SC3-0140	72	48.0	14.0	11.0	45			170180	
SC3-0160	72	48.0	16.0	12.0	45			170181	
SC3-0180	72	48.0	18.0	14.5	45			170182	
SC3-0200	72	48.0	20.0	16.0	45			170183	
SC3-0220	72	48.0	22.0	18.0	45			170184	
SC3-0250	72	48.0	25.0	20.0	45			170185	
SC4-0180	96	60.0	18.0	14.5	68				170186
SC4-0200	96	60.0	20.0	16.0	68				170187
SC4-0220	96	60.0	22.0	18.0	68				170188
SC4-0250	96	60.0	25.0	20.0	68				170189
SC4-0280	96	60.0	28.0	22.0	68				170190
SC4-0320	96	60.0	32.0	24.0	68				170191
SC4-0360	96	60.0	36.0	29.0	68				170192























Твердосплавные спиральные сверла
Wiertła pełnowęglkowe



sur demande
auf Anfrage
on request
su richiesta
sobre pedido

							F313VS	F285VS	F286VS	
<p>F313VS</p>										
<p>F285VS F286VS</p>										
$\varnothing d_1$ (h_7)	d_2 (h_6) mm	l_1 mm	l_2 mm				ID			
0.88	3.0	38.0	8.0	2	M 1		158515			
1.08	3.0	38.0	10.0	2	M 1.2		158516			
1.25	3.0	38.0	12.0	2	M 1.4		158517			
1.45	3.0	38.0	12.0	2	M 1.6		158518			
1.65	3.0	38.0	12.0	2	M 1.8		158519			
1.80	3.0	38.0	12.0	2	M 2		158520			
1.95	3.0	38.0	12.0	2	UNC 2-56		158521			
2.30	3.0	38.0	16.0	2	M 2.5		158522			
2.55	3.0	38.0	16.0	2	UNC 4-40		158523			
2.80	3.0	38.0	16.0	2	M 3		158524			
							ID			
$\varnothing d_1$ (m_7)	d_2 (h_6) mm	l_1 mm	l_2 mm	l_3 mm						
3.25	6.0	62.0	20.0	14.0	2	M 3.5	158527			
3.70	6.0	62.0	20.0	14.0	2	M 4	158528			
4.65	6.0	66.0	24.0	17.0	2	M 5	158532			
5.55	6.0	66.0	28.0	20.0	2	M 6	158534			
7.40	8.0	79.0	41.0	29.0	2	M 8	158540			
9.30	10.0	89.0	47.0	35.0	2	M 10	158544			
11.20	12.0	102.0	55.0	40.0	2	M 12	158546			
							ID			
$\varnothing d_1$ (m_7)	d_2 (h_6) mm	l_1 mm	l_2 mm	l_3 mm						
3.30	6.0	66.0	28.0	23.0	2	M 4	160989			
4.20	6.0	74.0	36.0	29.0	2	M 5	160990			
5.00	6.0	82.0	44.0	35.0	2	M 6	160991			
6.80	8.0	91.0	53.0	43.0	2	M 8	160992			
8.50	10.0	103.0	61.0	49.0	2	M 10	160993			
10.20	12.0	118.0	71.0	56.0	2	M 12	160994			



Наборы метчиков
Akcesoria do gwintowania

Boxset		D5855	D5860	D5891
D5855	  N1110-S M3, M4, M5, M6, M8, M10 N1210-S M12			
D5860	  N1110-S M3, M4, M5, M6, M8, M10 N1210-S M12   FO DIN 338 D2.5, 3.3, 4.2, 5.0, 6.8, FO DIN 338 8.5, 10.2			
D5891	  N310-3 M3, M4, M5, M6, M8, M10 N410-3 M12			
No D5855 / D5860 / D5891		ID	ID	ID
M3 - M12		118728	118733	170922
Boxset		D5892		
D5892	   N320V-4 M3, M4, M5, M6, M8, M10 			
No D5892			ID	
M3 - M10			170921	
Boxset		D5896		
D5896	   N360V-3 M3, M4, M5, M6, M8, M10 			
No D5896			ID	
M3 - M10			167599	

Плашкодержатели и воротки для метчиков
Oprawki do narzynek i klucze do gwintowników

<p>D5810- Плашкодержатели для круглых плашек по DIN EN 22568, DIN EN 24230, DIN EN 24231, DIN EN 40434. Oprawki do narzynek okrągłych wg DIN EN 22568, DIN EN 24230, DIN EN 24231, DIN EN 40434.</p> <p>D5820- Воротки для метчиков, регулируемые DIN 1814 Klucze do gwintowników, regulowane DIN 1814</p>									D5810-	D5820-
										
DIN EN No D5810-	M Ø	MF Ø	UNC Ø	UNF Ø	UNEF UNS UN Ø	W Ø	G (BSP) Ø	NPT NPTF R (BSPT) Ø	ID	
1	16 x 5	1 - 2.6	2 - 2.6	No 1 - 4	No 1 - 4		1/16" - 3/32"		170712	
2	20 x 5	3 - 4	3 - 6	No 5	No 5 - 6		1/8"		170713	
3	20 x 7	4.5 - 6		No 6 - 1/4"	No 8 - 1/4"	No 12 - 1/4"	5/32" - 1/4"		170714	
4	25 x 9	7 - 9	7 - 9	5/16"	5/16"	5/16"	5/16"	1/16"	170715	
5	30 x 11	10 - 11	10 - 11	3/8" - 7/16"	3/8" - 7/16"	3/8" - 7/16"	3/8" - 7/16"	1/8"	170716	
6	38 x 10		12 - 15		1/2" - 9/16"	1/2" - 9/16"		1/4"	170717	
7	38 x 14	12 - 14		1/2" - 9/16"			1/2" - 9/16"	1/4"	170718	
8	45 x 14		16 - 20		5/8" - 3/4"	5/8" - 13/16"		3/8" - 1/2"	170719	
9	45 x 18	16 - 20		5/8" - 3/4"			5/8" - 3/4"	1/2"	170720	
10	55 x 16		22 - 26		7/8" - 1"	7/8" - 1"		5/8" - 3/4"	170721	
11	55 x 22	22 - 24		7/8" - 1"			7/8" - 1"	3/4"	170722	
12	65 x 18		*27 - 36		1 1/8" - 1 3/8"	1 1/16" - 1 3/8"		7/8" - 1"	170723	
13	65 x 25	27 - 36		1 1/8" - 1 3/8"			1 1/8" - 1 3/8"	1"	170724	
14	75 x 20		38 - 42		1 1/2"	1 7/16" - 1 1/2"		1 1/8" - 1 1/4"	170725	
15	75 x 30	39 - 42		1 1/2"			1 1/2" - 1 5/8"		170726	
16	90 x 22		45 - 52			1 3/4" - 2"		1 3/8" - 1 3/4"	170727	
17	90 x 36	45 - 52		1 3/4" - 2"			1 3/4" - 2"		170728	
18	105 x 22		55 - 65				2" - 2 1/4"		170729	
<p>* Для шага 3 мм используйте №13 Do skoków 3 mm użyj Nr. 13</p>										
No D5820-	a mm								ID	
0	1.9 - 3.0								170730	
1	2.5 - 5.5								170731	
2	4.3 - 8.0								170732	
3	5.5 - 12.0								170733	
4	9.5 - 15.5								170734	
5	12.5 - 22.4								170735	

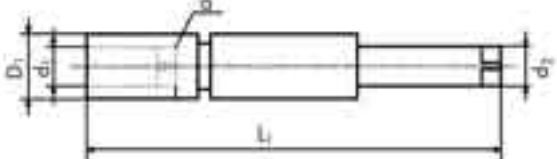
Удлинитель для метчиков
Przedłużki do gwintowników

D5830- D5840-		Удлинитель для метчиков по DIN 377. Przedłużki do gwintowników, zbliżone do DIN 377.		D5830-	D5840-		
		Удлинитель для метчиков. Przedłużki do gwintowników.					
							
No	a	L ₁	D ₁	ID			
D5830-	mm	mm	mm				
1	2.10	60	6	110571			
2	2.24	70	6	110572			
3	2.40	70	6	110573			
4	2.50	80	7	110574			
5	2.80	90	7	110575			
6	3.00	90	7	110579			
7	3.15	95	7	110580			
8	3.40	95	8	110581			
9	3.55	100	8	118706			
10	3.80	100	9	118707			
11	4.00	105	10	118708			
12	4.30	105	10	118709			
13	4.50	105	10	118710			
14	4.90	110	10	118711			
15	5.00	110	11	118712			
16	5.50	115	12	118713			
17	5.60	110	12	118714			
18	6.20	120	14	118715			
19	6.30	120	14	118716			
20	7.00	125	15	118717			
21	7.10	120	15	118718			
22	7.50	120	15	118719			
23	8.00	125	17	118720			
24	9.00	130	19	118721			
25	10.00	140	21	110562			
26	11.00	150	23	110563			
27	11.20	145	23	110564			
28	12.00	155	25	110565			
29	12.50	160	25	110566			
30	14.00	165	28	110567			
31	14.50	175	29	110568			
32	16.00	180	30	110569			
33	18.00	200	33	110570			
34	20.00	220	36	110576			
35	22.00	220	40	110577			
36	22.40	240	40	110578			
No	a	L ₁	d ₂	d ₁	D ₁	ID	
D5840-	mm	mm	mm	mm	mm		
10	2.70	130	6	3.5	7.5	169928	
11	3.40	130	6	4.5	8.5	169929	
1	4.90	130	6	6.0	12.0	142137	
2	5.50	130	7	7.0	13.0	142138	
3	6.20	130	8	8.0	13.0	142139	
4	7.00	130	9	9.0	17.0	142140	
5	8.00	130	10	10.0	17.0	142141	
6	9.00	130	11	11.0	17.0	142142	
7	9.00	130	12	12.0	20.0	142143	
8	11.00	130	14	14.0	20.0	142144	
9	12.00	130	16	16.0	25.0	142145	

ШКАЛА ТВЕРДОСТИ – TABELA TWARDOŚCI

HRC	HB	HV	N/mm ² Mpa
<i>Твердость по Роквеллу</i>	<i>Твердость по Бринеллю</i>	<i>Твердость по Викерсу</i>	<i>Предел прочности</i>
Twardość wg Rockwell'a	Twardość wg Brinell'a	Twardość wg Vickers'a	Wytrzymałość na rozciąganie
25	253	266	854
26	254	273	873
27	265	279	897
28	272	286	914
29	274	294	944
30	287	302	970
31	295	310	995
32	302	318	1024
33	311	327	1052
34	320	336	1082
35	329	345	1111
36	337	355	1139
37	346	364	1168
38	354	373	1198
39	363	382	1227
40	373	392	1262
41	382	402	1296
42	392	412	1327
43	402	423	1362
44	413	434	1401
45	424	446	1442
46	436	459	1481
47	448	471	1524
48	460	484	1572
49	474	499	1625
50	488	513	1668
51	502	528	1733
52	518	545	1793
53	532	560	1845
54	548	578	1912
55	566	596	1979
56	585	615	2050
57	603	634	2121
58		654	
59		675	
60		698	

Соответствие шкал твердости согласно DIN50150

Tabela przeliczeniowa dla wartości twardości, zgodna z DIN 50150

ДЮЙМЫ-ММ – CAL-ММ

Ø" d ₁	Ø mm	TPI UN											W(BSW)	BSF	G (BSP) R _p	Ø mm			
		UNC	UNF	UNEF	4	6	8	12	16	20	28	32							
0 1/16"	1.52 1.59		80											48		28	7.72		
1 2 3/32"	1.85 2.18 2.38	64 56	72 64																
3 4 5 1/8"	2.51 2.84 3.17 3.17 3.50	48 40 40 32	56 48 44 40											40		28	9.72		
5/32" 8 3/16" 10 12	3.96 4.16 4.76 4.82 5.48	32 32 24 24	36 36 32 28											32 24	32				
7/32" 1/4" 9/32" 5/16" 3/8"	5.55 6.35 7.14 7.93 9.52	20 18 16	28 24 24	32 32										24 20 16	28 26 20	19 19	13.15 16.66		
7/16" 1/2" 9/16" 5/8" 11/16"	11.11 12.70 14.28 15.87 17.46	14 13 12 11	20 20 18 18	28 28 24 24					16 16 16 12 12					32 32 32 28 32	14 12 12 11 14	18 16 16 14	14 14	20.95 22.91	
3/4" 13/16" 7/8" 15/16" 1"	19.05 20.64 22.22 23.81 25.40	10 9 8	16 14 12	20 20 20 20				12 12 12						28 28 28 28	32 32 32	10 9 8	12 12 11	14 14 11	26.44 30.20 33.24
1 1/16" 1 1/8" 1 3/16" 1 1/4" 1 5/16"	26.99 28.57 30.16 31.75 33.34	7 7	12 12	18 18 18			8 8 8	12 12 12	16 16 16	20 20 20	28 28 28			7 7	9 9	11 11	37.89 41.91		
1 3/8" 1 7/16" 1 1/2" 1 9/16" 1 5/8"	34.92 36.51 38.10 39.69 41.28	6 6	12 12	18 18 18			8 8 8	12 12 12	16 16 16	20 20 20	28 28			6 6 5	8 8	11 11	44.32 47.80		
1 11/16" 1 3/4" 1 13/16" 1 7/8" 1 15/16"	42.86 44.45 46.04 47.63 49.21	5		18			8 8 8	12 12 12	16 16 16	20 20 20				5 4 1/2	7	11	53.74		
2" 2 1/8" 2 1/4" 2 3/8" 2 1/2"	50.80 53.97 57.15 60.32 63.50	4 1/2 4 1/2 4					8 8 8	12 12 12	16 16 16	20 20 20				4 1/2 4 4	7 6 6	11 11 11	59.61 65.71 75.18		
2 5/8" 2 3/4" 2 7/8" 3" 3 1/8"	66.67 69.85 73.02 76.20 79.37	4 4 4					8 8 8	12 12 12	16 16 16	20 20 20				3 1/2 3 1/2	6 5	11 11	81.53 87.88		
3 1/4" 3 3/8" 3 1/2" 3 5/8" 3 3/4"	82.55 85.72 88.90 92.07 95.25	4 4 4					8 8 8	12 12 12	16 16 16					3 1/4 3 1/4 3	5 4 1/2 4 1/2	11 11 11	93.98 100.33 106.68		
3 7/8" 4"	98.42 101.60	4					8 8	12 12	16 16					3 3	4 1/2	11	113.03		



ПЕРЕВОДНАЯ ТАБЛИЦА – TABELA PRZELICZENIOWA

	Vc m/min															
	1	2	3	4	5	6	8	10	12	15	20	25	30	40	50	60
	min ⁻¹															
1	318	637	955	1273	1592	1910	2546	3183	3820	4775	6366	7958	9549	12732	15915	19099
2	159	318	477	637	796	955	1273	1592	1910	2387	3183	3979	4775	6366	7958	9549
3	106	212	318	424	531	637	849	1061	1273	1592	2122	2653	3183	4244	5305	6366
4	80	159	239	318	398	477	637	796	955	1194	1592	1989	2387	3183	3979	4775
5	64	127	191	255	318	382	509	637	764	955	1273	1592	1910	2546	3183	3820
6	53	106	159	212	265	318	424	531	637	796	1061	1326	1592	2122	2653	3183
8	40	80	119	159	199	239	318	398	477	597	796	995	1194	1592	1989	2387
10	32	64	95	127	159	191	255	318	382	477	637	796	955	1273	1592	1910
12	27	53	80	106	133	159	212	265	318	398	531	663	796	1061	1326	1592
14	23	45	68	91	114	136	182	227	273	341	455	568	682	909	1137	1364
16	20	40	60	80	99	119	159	199	239	298	398	497	597	796	995	1194
18	18	35	53	71	88	106	141	177	212	265	354	442	531	707	884	1061
20	16	32	48	64	80	95	127	159	191	239	318	398	477	637	796	955
25	13	25	38	51	64	76	102	127	153	191	255	318	382	509	637	764
30	11	21	32	42	53	64	85	106	127	159	212	265	318	424	531	637
35	9	18	27	36	45	55	73	91	109	136	182	227	273	364	455	546
40	8	16	24	32	40	48	64	80	95	119	159	199	239	318	398	477
45	7	14	21	28	35	42	57	71	85	106	141	177	212	283	354	424
50	6	13	19	25	32	38	51	64	76	95	127	159	191	255	318	382

ОТВЕРСТИЯ ПОД РЕЗЬБЫ – ŚREDNICE OTWORÓW

M DIN 13, ISO 261, *5H / 6H

Ø	P	Внутренний диаметр гайки Średnica otworu			
		Ø mini	Ø maxi	Ø guide line	
d _i	mm				
* 1	0.25	0.729	0.785	0.75	
* 1.1	0.25	0.829	0.885	0.85	
* 1.2	0.25	0.929	0.985	0.95	
* 1.4	0.30	1.075	1.142	1.10	
1.6	0.35	1.221	1.321	1.25	
1.7	0.35	1.321	1.421	1.35	
1.8	0.35	1.421	1.521	1.45	
2	0.40	1.567	1.679	1.60	
2.2	0.45	1.713	1.838	1.75	
2.3	0.40	1.867	1.979	1.90	
2.5	0.45	2.013	2.138	2.05	
2.6	0.45	2.113	2.238	2.15	
3	0.50	2.459	2.599	2.50	
3.5	0.60	2.850	3.010	2.90	
4	0.70	3.242	3.422	3.30	
4.5	0.75	3.688	3.878	3.75	
5	0.80	4.134	4.334	4.20	
6	1.00	4.917	5.153	5.00	
7	1.00	5.917	6.153	6.00	
8	1.25	6.647	6.912	6.80	
9	1.25	7.647	7.912	7.80	
10	1.50	8.376	8.676	8.50	
11	1.50	9.376	9.676	9.50	
12	1.75	10.106	10.441	10.20	
14	2.00	11.835	12.210	12.00	
16	2.00	13.835	14.210	14.00	
18	2.50	15.294	15.744	15.50	
20	2.50	17.294	17.744	17.50	
22	2.50	19.294	19.744	19.50	
24	3.00	20.752	21.252	21.00	
27	3.00	23.752	24.252	24.00	
30	3.50	26.211	26.771	26.50	
33	3.50	29.211	29.771	29.50	
36	4.00	31.670	32.270	32.00	
39	4.00	34.670	35.270	35.00	
42	4.50	37.129	37.799	37.50	
45	4.50	40.129	40.799	40.50	
48	5.00	42.587	43.297	43.00	
52	5.00	46.587	47.297	47.00	
56	5.50	50.046	50.796	50.50	

MF DIN 13, ISO 261, 6H

Ø	P	Внутренний диаметр гайки Średnica otworu			
		Ø mini	Ø maxi	Ø guide line	
d _i	mm				
2.5	0.35	2.121	2.221	2.15	
3	0.35	2.621	2.721	2.65	
3.5	0.35	3.121	3.221	3.15	
4	0.50	3.459	3.599	3.50	
4.5	0.50	3.959	4.099	4.00	
5	0.50	4.459	4.599	4.50	
5.5	0.50	4.959	5.099	5.00	
6	0.75	5.188	5.378	5.25	
7	0.75	6.188	6.378	6.25	
8	0.75	7.188	7.378	7.25	

MF DIN 13, ISO 261, 6H

Ø	P	Внутренний диаметр гайки Średnica otworu			
		Ø mini	Ø maxi	Ø guide line	
d _i	mm				
8	1.00	6.917	7.153	7.00	
9	0.75	8.188	8.378	8.25	
9	1.00	7.917	8.153	8.00	
10	0.75	9.188	9.378	9.25	
10	1.00	8.917	9.153	9.00	
10	1.25	8.647	8.912	8.80	
11	0.75	10.188	10.378	10.25	
11	1.00	9.917	10.153	10.00	
12	1.00	10.917	11.153	11.00	
12	1.25	10.647	10.912	10.80	
12	1.50	10.376	10.676	10.50	
14	1.00	12.917	13.153	13.00	
14	1.25	12.647	12.912	12.80	
14	1.50	12.376	12.676	12.50	
15	1.00	13.917	14.153	14.00	
15	1.50	13.376	13.676	13.50	
16	1.00	14.917	15.153	15.00	
16	1.50	14.376	14.676	14.50	
17	1.00	15.917	16.153	16.00	
17	1.50	15.376	15.676	15.50	
18	1.00	16.917	17.153	17.00	
18	1.50	16.376	16.676	16.50	
18	2.00	15.835	16.210	16.00	
20	1.00	18.917	19.153	19.00	
20	1.50	18.376	18.676	18.50	
20	2.00	17.835	18.210	18.00	
22	1.00	20.917	21.153	21.00	
22	1.50	20.376	20.676	20.50	
22	2.00	19.835	20.210	20.00	
24	1.00	22.917	23.153	23.00	
24	1.50	22.376	22.676	22.50	
24	2.00	21.835	22.210	22.00	
25	1.00	23.917	24.153	24.00	
25	1.50	23.376	23.676	23.50	
25	2.00	22.835	23.210	23.00	
27	1.50	25.376	25.676	25.50	
27	2.00	24.835	25.210	25.00	
28	1.00	26.917	27.153	27.00	
28	1.50	26.376	26.676	26.50	
28	2.00	25.835	26.210	26.00	
30	1.00	28.917	29.153	29.00	
30	1.50	28.376	28.676	28.50	
30	2.00	27.835	28.210	28.00	
32	1.50	30.376	30.676	30.50	
32	2.00	29.835	30.210	30.00	
33	1.50	31.376	31.676	31.50	
33	2.00	30.835	31.210	31.00	
35	1.50	33.376	33.676	33.50	
36	1.50	34.376	34.676	34.50	
36	2.00	33.835	34.210	34.00	
36	3.00	32.752	33.252	33.00	
39	1.50	37.376	37.676	37.50	
39	2.00	36.835	37.210	37.00	
39	3.00	35.752	36.252	36.00	
40	1.50	38.376	38.676	38.50	



ОТВЕРСТИЯ ПОД РЕЗЬБЫ – ŚREDNICE OTWORÓW

MF DIN 13, ISO 261, 6H

Ø	P	Внутренний диаметр гайки Średnica otworu			
		Ø mini	Ø maxi	Ø guide line	
d _i	mm				
40	2.00	37.835	38.210	38.00	
40	3.00	36.752	37.252	37.00	
42	1.50	40.376	40.676	40.50	
42	2.00	39.835	40.210	40.00	
42	3.00	38.752	39.252	39.00	
45	1.50	43.376	43.676	43.50	
45	2.00	42.835	43.210	43.00	
45	3.00	41.752	42.252	42.00	
48	1.50	46.376	46.676	46.50	
48	2.00	45.835	46.210	46.00	
48	3.00	44.752	45.252	45.00	
50	1.50	48.376	48.676	48.50	
50	2.00	47.835	48.210	48.00	
50	3.00	46.752	47.252	47.00	
52	1.50	50.376	50.676	50.50	
52	2.00	49.835	50.210	50.00	
52	3.00	48.752	49.252	49.00	
55	2.00	52.835	53.210	53.00	
60	2.00	57.835	58.210	58.00	

MF EN 60423:1994, 7H

Ø	P	Внутренний диаметр гайки Średnica otworu			
		Ø mini	Ø maxi	Ø guide line	
d _i	mm				
8	1.00	6.917	7.217	7.00	
10	1.00	8.917	9.217	9.00	
12	1.50	10.376	10.751	10.50	
16	1.50	14.376	14.751	14.50	
20	1.50	18.376	18.751	18.50	
25	1.50	23.376	23.751	23.50	
32	1.50	30.376	30.751	30.50	
40	1.50	38.376	38.751	38.50	
63	1.50	61.376	61.751	61.50	

UNC ANSI B1.1, 2B

Ø	P	P	Внутренний диаметр гайки Średnica otworu			
			Ø mini	Ø maxi	Ø guide line	
d _i	TPI	mm				
1	64	0.397	1.425	1.582	1.45	
2	56	0.454	1.695	1.871	1.75	
3	48	0.529	1.941	2.146	2.00	
4	40	0.635	2.157	2.385	2.25	
5	40	0.635	2.487	2.697	2.55	
6	32	0.794	2.642	2.895	2.75	
8	32	0.794	3.302	3.530	3.40	
10	24	1.058	3.683	3.962	3.80	
12	24	1.058	4.344	4.597	4.40	
1/4"	20	1.270	4.979	5.257	5.10	
5/16"	18	1.411	6.401	6.731	6.50	

UNC ANSI B1.1, 2B

Ø	P	P	Внутренний диаметр гайки Średnica otworu			
			Ø mini	Ø maxi	Ø guide line	
d _i	TPI	mm				
3/8"	16	1.588	7.798	8.153	8.00	
7/16"	14	1.814	9.144	9.550	9.30	
1/2"	13	1.954	10.592	11.023	10.80	
9/16"	12	2.117	11.989	12.446	12.20	
5/8"	11	2.309	13.386	13.868	13.60	
3/4"	10	2.540	16.307	16.840	16.60	
7/8"	9	2.822	19.177	19.761	19.50	
1"	8	3.175	21.971	22.606	22.30	
1 1/8"	7	3.629	24.638	25.349	25.00	
1 1/4"	7	3.629	27.813	28.524	28.20	
1 3/8"	6	4.233	30.353	31.115	30.80	
1 1/2"	6	4.233	33.528	34.290	34.00	
1 3/4"	5	5.080	38.964	39.827	39.50	
2"	4.5	5.644	44.679	45.593	45.30	

UNJC ISO 3161:1999, 3B

Ø	P	P	Внутренний диаметр гайки Średnica otworu			
			Ø mini	Ø maxi	Ø guide line	
d _i	TPI	mm				
4	40	0.635	2.228	2.393	2.30	
5	40	0.635	2.558	2.723	2.60	
6	32	0.794	2.733	2.939	2.80	
8	32	0.794	3.393	3.599	3.45	
10	24	1.058	3.795	4.064	3.90	
12	24	1.058	4.455	4.704	4.55	
1/4"	20	1.270	5.113	5.387	5.20	
5/16"	18	1.411	6.563	6.833	6.70	
3/8"	16	1.588	7.978	8.255	8.10	
7/16"	14	1.814	9.347	9.639	9.40	
1/2"	13	1.954	10.798	11.095	10.90	
9/16"	12	2.117	12.228	12.482	12.40	
5/8"	11	2.309	13.627	13.904	13.80	
3/4"	10	2.540	16.576	16.881	16.70	

ОТВЕРСТИЯ ПОД РЕЗЬБЫ – ŚREDNICE OTWORÓW

UNF ANSI B1.1, 2B

Ø	P	P	Внутренний диаметр гайки		
			Średnica otworu		
d _i	TPI	mm	Ø mini	Ø maxi	Ø guide line
0	80	0.318	1.182	1.305	1.20
1	72	0.353	1.474	1.612	1.50
2	64	0.397	1.756	1.912	1.80
3	56	0.454	2.025	2.197	2.10
4	48	0.529	2.271	2.458	2.35
5	44	0.577	2.551	2.740	2.60
6	40	0.635	2.820	3.022	2.90
8	36	0.706	3.404	3.606	3.50
10	32	0.794	3.963	4.165	4.05
12	28	0.907	4.496	4.724	4.60
1/4"	28	0.907	5.360	5.588	5.50
5/16"	24	1.058	6.782	7.035	6.90
3/8"	24	1.058	8.382	8.636	8.50
7/16"	20	1.270	9.729	10.033	9.80
1/2"	20	1.270	11.329	11.607	11.40
9/16"	18	1.411	12.751	13.081	12.90
5/8"	18	1.411	14.351	14.681	14.50
3/4"	16	1.588	17.323	17.678	17.50
7/8"	14	1.814	20.270	20.675	20.40
1"	12	2.117	23.114	23.571	23.30
1 1/8"	12	2.117	26.289	26.746	26.50
1 1/4"	12	2.117	29.464	29.921	29.70
1 3/8"	12	2.117	32.639	33.096	32.80
1 1/2"	12	2.117	35.814	36.271	36.00

UNJF ISO 3161:1999, 3B

Ø	P	P	Внутренний диаметр гайки		
			Średnica otworu		
d _i	TPI	mm	Ø mini	Ø maxi	Ø guide line
0	80	0.318	1.217	1.298	1.25
1	72	0.353	1.511	1.603	1.55
2	64	0.397	1.798	1.902	1.85
3	56	0.454	2.073	2.189	2.15
4	48	0.529	2.329	2.466	2.35
5	44	0.577	2.614	2.764	2.70
6	40	0.635	2.888	3.053	2.95
8	36	0.706	3.480	3.663	3.60
10	32	0.794	4.054	4.255	4.10
12	28	0.907	4.602	4.816	4.70
1/4"	28	0.907	5.466	5.662	5.55
5/16"	24	1.058	6.906	7.109	7.00
3/8"	24	1.058	8.494	8.679	8.60
7/16"	20	1.270	9.876	10.084	10.00
1/2"	20	1.270	11.463	11.661	11.55
9/16"	18	1.411	12.913	13.122	13.05
5/8"	18	1.411	14.501	14.702	14.60
3/4"	16	1.588	17.506	17.722	17.60
7/8"	14	1.814	20.460	20.706	20.50
1"	12	2.117	23.340	23.594	23.40

UNEF ANSI B1.1, 2B

Ø	P	P	Внутренний диаметр гайки		
			Średnica otworu		
d _i	TPI	mm	Ø mini	Ø maxi	Ø guide line
12	32	0.794	4.623	4.826	4.70
1/4"	32	0.794	5.487	5.689	5.60
5/16"	32	0.794	7.087	7.264	7.20
3/8"	32	0.794	8.662	8.864	8.75
7/16"	28	0.907	10.135	10.337	10.25
1/2"	28	0.907	11.710	11.938	11.85
9/16"	24	1.058	13.132	13.385	13.20
5/8"	24	1.058	14.732	14.986	14.80
11/16"	24	1.058	16.307	16.560	16.40
3/4"	20	1.270	17.679	17.957	17.80
13/16"	20	1.270	19.254	19.558	19.40
7/8"	20	1.270	20.854	21.132	21.00
1"	20	1.270	24.029	24.307	24.10

UN ANSI B1.1, 2B

Ø	P	P	Внутренний диаметр гайки		
			Średnica otworu		
d _i	TPI	mm	Ø mini	Ø maxi	Ø guide line
5/16"	20	1.270	6.554	6.858	6.70
3/8"	20	1.270	8.154	8.432	8.30
9/16"	20	1.270	12.904	13.208	13.00
5/8"	20	1.270	14.504	14.782	14.60
1 1/8"	8	3.175	25.146	25.781	25.50
1 1/4"	8	3.175	28.321	28.956	28.70
1 3/8"	8	3.175	31.496	32.131	31.80
1 1/2"	8	3.175	34.671	35.306	35.00
1 5/8"	8	3.175	37.846	38.481	38.20
1 3/4"	8	3.175	41.021	41.656	41.40
1 7/8"	8	3.175	44.196	44.831	44.50
2"	8	3.175	47.371	48.006	47.70
2 1/4"	8	3.175	53.721	54.356	54.10
2 1/2"	8	3.175	60.071	60.706	60.40



ОТВЕРСТИЯ ПОД РЕЗЬБЫ – ŚREDNICE OTWORÓW

UNS ANSI B1.1, 2B

Ø	P	P	Внутренний диаметр гайки		
			Średnica otworu		
d _i	TPI	mm	Ø mini	Ø maxi	Ø guide line
10	36	0.706	4.064	4.216	4.10
10	40	0.635	4.141	4.292	4.20
10	56	0.454	4.344	4.445	4.40
1/4"	36	0.706	5.588	5.740	5.65
1/4"	40	0.635	5.665	5.816	5.70
1/4"	48	0.529	5.766	5.892	5.80
1/4"	56	0.454	5.868	5.969	5.90
5/16"	36	0.706	7.163	7.340	7.25
3/8"	36	0.706	8.763	8.940	8.80
7/16"	24	1.058	9.957	10.210	10.00
1/2"	24	1.058	11.557	11.811	11.60
1"	14	1.814	23.445	23.825	23.60

W (BSW) BS 84, (DIN11 - 1970)

Ø	P	P	Внутренний диаметр гайки		
			Średnica otworu		
d _i	TPI	mm	Ø mini	Ø maxi	Ø guide line
(3/32")	48				1.80
1/8"	40	0.635	2.362	2.591	2.50
(5/32")	32				3.10
3/16"	24	1.058	3.406	3.744	3.60
(7/32")	24				4.40
1/4"	20	1.270	4.724	5.156	4.90
5/16"	18	1.411	6.129	6.588	6.40
3/8"	16	1.588	7.493	7.988	7.70
7/16"	14	1.814	8.791	9.332	9.10
1/2"	12	2.117	9.987	10.589	10.30
5/8"	11	2.309	12.918	13.558	13.30
3/4"	10	2.540	15.799	16.484	16.20
7/8"	9	2.822	18.613	19.355	19.25
1"	8	3.175	21.336	22.149	21.90

G (BSP) DIN ISO 228

Ø	P	P	Внутренний диаметр гайки		
			Średnica otworu		
d _i	TPI	mm	Ø mini	Ø maxi	Ø guide line
1/16"	28	0.907	6.561	6.843	6.75
1/8"	28	0.907	8.566	8.848	8.75
1/4"	19	1.337	11.445	11.890	11.60
3/8"	19	1.337	14.950	15.395	15.20
1/2"	14	1.814	18.631	19.172	18.90
5/8"	14	1.814	20.587	21.128	20.90
3/4"	14	1.814	24.117	24.658	24.40
7/8"	14	1.814	27.877	28.418	28.20
1"	11	2.309	30.291	30.931	30.70
1 1/8"	11	2.309	34.939	35.579	35.30
1 1/4"	11	2.309	38.952	39.592	39.30
1 3/8"	11	2.309	41.365	42.005	41.80
1 1/2"	11	2.309	44.845	45.485	45.20
1 3/4"	11	2.309	50.788	51.428	51.20
2"	11	2.309	56.656	57.296	57.00
2 1/4"	11	2.309	62.752	63.392	63.10
2 1/2"	11	2.309	72.226	72.866	72.60
3"	11	2.309	84.926	85.566	85.30

PG DIN 40430

Ø	P	P	Внутренний диаметр гайки		
			Średnica otworu		
d _i	TPI	mm	Ø mini	Ø maxi	Ø guide line
7	20	1.270	11.28	11.43	11.35
9	18	1.411	13.86	14.01	13.90
11	18	1.411	17.26	17.41	17.30
13.5	18	1.411	19.06	19.21	19.10
16	18	1.411	21.16	21.31	21.20
21	16	1.588	26.78	27.03	26.80
29	16	1.588	35.48	35.73	35.50
36	16	1.588	45.48	45.73	45.50
42	16	1.588	52.48	52.73	52.50
48	16	1.588	57.78	58.03	57.80

TR ISO 2901-2904, DIN 103, 7H

Ø	P	Внутренний диаметр гайки		
		Średnica otworu		
d _i	mm	Ø mini	Ø maxi	Ø guide line
10	2	8	8.236	8.20
12	3	9	9.315	9.25
14	3	11	11.315	11.25
16	4	12	12.375	12.25
18	4	14	14.375	14.25
20	4	16	16.375	16.25
22	5	17	17.450	17.25
24	5	19	19.450	19.25
26	5	21	21.450	21.25
28	5	23	23.450	23.25
30	6	24	24.500	24.25
32	6	26	26.500	26.25

ДИАМЕТРЫ ПОД ПЛАШКИ – ŚREDNICE WAŁKÓW

M DIN 13, ISO 261, *6h / 6g

Ø	P	Наружный диаметр резьбы Średnica zewnętrzna		
		Ø mini	Ø maxi	Ø guide line
d _i	mm			
* 1	0.25	0.933	1.000	0.97
* 1.1	0.25	1.033	1.100	1.07
* 1.2	0.25	1.133	1.200	1.17
* 1.4	0.30	1.325	1.400	1.36
1.6	0.35	1.496	1.581	1.54
1.7	0.35	1.596	1.681	1.64
1.8	0.35	1.696	1.781	1.74
2	0.40	1.886	1.981	1.93
2.2	0.45	2.080	2.180	2.13
2.3	0.40	2.186	2.300	2.23
2.5	0.45	2.380	2.480	2.43
2.6	0.45	2.480	2.600	2.53
3	0.50	2.874	2.980	2.92
3.5	0.60	3.354	3.479	3.41
4	0.70	3.838	3.978	3.91
4.5	0.75	4.338	4.478	4.40
5	0.80	4.826	4.976	4.90
6	1.00	5.794	5.974	5.88
7	1.00	6.794	6.974	6.88
8	1.25	7.760	7.972	7.87
9	1.25	8.760	8.972	8.87
10	1.50	9.732	9.968	9.85
11	1.50	10.732	10.968	10.85
12	1.75	11.701	11.966	11.83
14	2.00	13.682	13.962	13.82
16	2.00	15.682	15.962	15.82
18	2.50	17.623	17.958	17.79
20	2.50	19.623	19.958	19.79
22	2.50	21.623	21.958	21.79
24	3.00	23.577	23.952	23.76
27	3.00	26.577	26.952	26.76
30	3.50	29.522	29.947	29.73
33	3.50	32.522	32.947	32.73
36	4.00	35.465	35.940	35.70
39	4.00	38.465	38.940	38.70
42	4.50	41.437	41.937	41.69
45	4.50	44.437	44.937	44.69
48	5.00	47.399	47.929	47.66
52	5.00	51.399	51.929	51.66
56	5.50	55.365	55.925	55.65

MF DIN 13, ISO 261, 6g

Ø	P	Наружный диаметр резьбы Średnica zewnętrzna		
		Ø mini	Ø maxi	Ø guide line
d _i	mm			
8	1.00	7.794	7.974	7.88
9	0.75	8.838	8.978	8.90
9	1.00	8.794	8.974	8.88
10	0.75	9.838	9.978	9.90
10	1.00	9.794	9.974	9.88
10	1.25	9.760	9.972	9.86
11	0.75	10.838	10.978	10.90
11	1.00	10.794	10.974	10.88
12	1.00	11.794	11.974	11.88
12	1.25	11.760	11.972	11.86
14	1.00	13.794	13.974	13.88
14	1.25	13.760	13.972	13.86
14	1.50	13.732	13.968	13.85
15	1.00	14.794	14.974	14.88
15	1.50	14.732	14.968	14.85
16	1.00	15.794	15.974	15.88
16	1.50	15.732	15.968	15.85
17	1.00	16.794	16.974	16.88
17	1.50	16.732	16.968	16.85
18	1.00	17.794	17.974	17.88
18	1.50	17.732	17.968	17.85
18	2.00	17.682	17.962	17.82
20	1.00	19.794	19.974	19.88
20	1.50	19.732	19.968	19.85
20	2.00	19.682	19.962	19.82
22	1.00	21.794	21.974	21.88
22	1.50	21.732	21.968	21.85
22	2.00	21.682	21.962	21.82
24	1.00	23.794	23.974	23.88
24	1.50	23.732	23.968	23.85
24	2.00	23.682	23.962	23.82
25	1.00	24.794	24.974	24.88
25	1.50	24.732	24.968	24.85
25	2.00	24.682	24.962	24.82
27	1.00	26.794	26.974	26.88
27	1.50	26.732	26.968	26.85
27	2.00	26.682	26.962	26.82
28	1.00	27.794	27.974	27.88
28	1.50	27.732	27.968	27.85
28	2.00	27.682	27.962	27.82
30	1.00	29.794	29.974	29.88
30	1.50	29.732	29.968	29.85
30	2.00	29.682	29.962	29.82
30	3.00	29.577	29.952	29.76
32	1.50	31.732	31.968	31.85
32	2.00	31.682	31.962	31.82
33	1.50	32.732	32.968	32.85
33	2.00	32.682	32.962	32.82
33	3.00	32.577	32.952	32.76
35	1.50	34.732	34.968	34.85
36	1.50	35.732	35.968	35.85
36	2.00	35.682	35.962	35.82
36	3.00	35.577	35.952	35.76
39	1.50	38.732	38.968	38.85
39	2.00	38.682	38.962	38.82
39	3.00	38.577	38.952	38.76

MF DIN 13, ISO 261, 6g

Ø	P	Наружный диаметр резьбы Średnica zewnętrzna		
		Ø mini	Ø maxi	Ø guide line
d _i	mm			
2.5	0.35	2.396	2.481	2.44
3	0.35	2.896	2.981	2.94
3.5	0.35	3.396	3.481	3.44
4	0.50	3.874	3.980	3.93
4.5	0.50	4.374	4.480	4.43
5	0.50	4.874	4.980	4.93
5.5	0.50	5.374	5.480	5.43
6	0.75	5.838	5.978	5.90
7	0.75	6.838	6.978	6.90
8	0.75	7.838	7.978	7.90



ДИАМЕТРЫ ПОД ПЛАШКИ – ŚREDNICE WAŁKÓW

MF DIN 13, ISO 261, 6g

Ø	P	Наружный диаметр резьбы Średnica zewnętrzna			
		Ø mini	Ø maxi	Ø guide line	
d _i	mm				
40	1.50	39.732	39.968	39.85	
40	2.00	39.682	39.962	39.82	
40	3.00	39.577	39.952	39.76	
42	1.50	41.732	41.968	41.85	
42	2.00	41.682	41.962	41.82	
42	3.00	41.577	41.952	41.76	
45	1.50	44.732	44.968	44.85	
45	2.00	44.682	44.962	44.82	
45	3.00	44.577	44.952	44.76	
48	1.50	47.732	47.968	47.85	
48	2.00	47.682	47.962	47.82	
48	3.00	47.577	47.952	47.76	
50	1.50	49.732	49.968	49.85	
50	2.00	49.682	49.962	49.82	
50	3.00	49.577	49.952	49.76	
52	1.50	51.732	51.968	51.85	
52	2.00	51.682	51.962	51.82	
52	3.00	51.577	51.952	51.76	
52	4.00	51.465	51.940	51.70	

UNC ANSI B1.1, 2A

Ø	P	Наружный диаметр резьбы Średnica zewnętrzna			
		Ø mini	Ø maxi	Ø guide line	
d _i	mm				
1	64	0.397	1.743	1.838	1.79
2	56	0.454	2.066	2.169	2.12
3	48	0.529	2.383	2.496	2.44
4	40	0.635	2.695	2.824	2.76
5	40	0.635	3.026	3.154	3.09
6	32	0.794	3.333	3.484	3.41
8	32	0.794	3.991	4.142	4.07
10	24	1.058	4.618	4.800	4.71
12	24	1.058	5.279	5.461	5.37
1/4"	20	1.270	6.117	6.322	6.22
5/16"	18	1.411	7.687	7.907	7.80
3/8"	16	1.588	9.254	9.491	9.37
7/16"	14	1.814	10.816	11.076	10.95
1/2"	13	1.954	12.386	12.661	12.52
9/16"	12	2.117	13.958	14.246	14.10
5/8"	11	2.309	15.528	15.834	15.68
3/4"	10	2.540	18.677	19.004	18.84
7/8"	9	2.822	21.824	22.176	22.00
1"	8	3.175	24.969	25.349	25.16
1 1/8"	7	3.629	28.103	28.519	28.31
1 1/4"	7	3.629	31.278	31.694	31.49
1 3/8"	6	4.233	34.402	34.864	34.63
1 1/2"	6	4.233	37.577	38.039	37.81
1 3/4"	5	5.080	43.860	44.381	44.12
2"	4.5	5.644	50.168	50.726	50.45
2 1/4"	4.5	5.644	56.518	57.076	56.80
2 1/2"	4	6.350	62.817	63.421	63.12
2 3/4"	4	6.350	69.165	69.768	69.47
3"	4	6.350	75.515	76.118	75.82
3 1/4"	4	6.350	81.862	82.466	82.16
3 1/2"	4	6.350	88.212	88.816	88.51

UNC ANSI B1.1, 2A

Ø	P	P	Наружный диаметр резьбы Średnica zewnętrzna			
			Ø mini	Ø maxi	Ø guide line	
d _i	TPI	mm				
3 3/4"	4	6.350	94.560	95.163	94.86	
4"	4	6.350	100.910	101.513	101.21	

UNF ANSI B1.1, 2A

Ø	P	P	Наружный диаметр резьбы Średnica zewnętrzna			
			Ø mini	Ø maxi	Ø guide line	
d _i	TPI	mm				
0	80	0.318	1.431	1.511	1.47	
1	72	0.353	1.751	1.838	1.79	
2	64	0.397	2.073	2.169	2.12	
3	56	0.454	2.393	2.496	2.44	
4	48	0.529	2.713	2.827	2.77	
5	44	0.577	3.036	3.157	3.10	
6	40	0.635	3.356	3.484	3.42	
8	36	0.706	4.006	4.145	4.08	
10	32	0.794	4.651	4.803	4.73	
12	28	0.907	5.296	5.461	5.38	
1/4"	28	0.907	6.160	6.324	6.24	
5/16"	24	1.058	7.727	7.909	7.82	
3/8"	24	1.058	9.315	9.497	9.41	
7/16"	20	1.270	10.874	11.079	10.98	
1/2"	20	1.270	12.462	12.666	12.56	
9/16"	18	1.411	14.031	14.251	14.14	
5/8"	18	1.411	15.619	15.839	15.73	
3/4"	16	1.588	18.774	19.011	18.89	
7/8"	14	1.814	21.923	22.184	22.05	
1"	12	2.117	25.065	25.354	25.21	
1 1/8"	12	2.117	28.240	28.529	28.38	
1 1/4"	12	2.117	31.415	31.704	31.56	
1 3/8"	12	2.117	34.588	34.876	34.73	
1 1/2"	12	2.117	37.763	38.051	37.91	

UNEF ANSI B1.1, 2A

Ø	P	P	Наружный диаметр резьбы Średnica zewnętrzna			
			Ø mini	Ø maxi	Ø guide line	
d _i	TPI	mm				
12	32	0.794	5.312	5.463	5.39	
1/4"	32	0.794	6.173	6.324	6.25	
5/16"	32	0.794	7.760	7.912	7.84	
3/8"	32	0.794	9.348	9.499	9.42	
7/16"	28	0.907	10.920	11.084	11.00	
1/2"	28	0.907	12.507	12.672	12.59	
9/16"	24	1.058	14.075	14.257	14.17	
5/8"	24	1.058	15.662	15.844	15.75	
11/16"	24	1.058	17.250	17.432	17.34	
3/4"	20	1.270	18.812	19.016	18.91	
13/16"	20	1.270	20.339	20.604	20.50	
7/8"	20	1.270	21.987	22.191	22.09	
15/16"	20	1.270	23.572	23.776	23.67	
1"	20	1.270	25.159	25.364	25.26	
1 1/8"	18	1.411	28.319	28.539	28.43	
1 1/4"	18	1.411	31.491	31.711	31.60	
1 1/2"	18	1.411	37.841	38.061	37.95	

ДИАМЕТРЫ ПОД ПЛАШКИ – ŚREDNICE WAŁKÓW

UN ANSI B1.1, 2A

Ø	P	P	Наружный диаметр резьбы		
			Średnica zewnętrzna		
d _i	TPI	mm	Ø mini	Ø maxi	Ø guide line
5/16"	20	1.270	7.702	7.907	7.80
3/8"	20	1.270	9.289	9.494	9.39
9/16"	20	1.270	14.049	14.254	14.15
5/8"	20	1.270	15.637	15.841	15.74
1 1/8"	8	3.175	28.141	28.521	28.33
1 1/4"	8	3.175	31.316	31.696	31.51
1 3/8"	8	3.175	34.489	34.869	34.68
1 1/2"	8	3.175	37.664	38.044	37.85
1 5/8"	8	3.175	40.839	41.219	41.03
1 3/4"	8	3.175	44.011	44.391	44.20
1 7/8"	8	3.175	47.186	47.566	47.38
2"	8	3.175	50.361	50.741	50.55
2 1/4"	8	3.175	56.709	57.089	56.90
2 1/2"	8	3.175	63.059	63.439	63.25
2 3/4"	8	3.175	69.406	69.786	69.60
3"	8	3.175	75.753	76.133	75.94

W (BSW) BS 84

Ø	P	P	Наружный диаметр резьбы		
			Średnica zewnętrzna		
d _i	TPI	mm	Ø mini	Ø maxi	Ø guide line
1/4"	20	1.270	6.165	6.319	6.24
5/16"	18	1.411	7.737	7.904	7.82
3/8"	16	1.588	9.312	9.489	9.40
7/16"	14	1.814	10.884	11.074	10.98
1/2"	12	2.117	12.456	12.662	12.56
5/8"	11	2.309	15.613	15.832	15.72
3/4"	10	2.540	18.771	19.004	18.89
7/8"	9	2.822	21.979	22.225	22.10
1"	8	3.175	25.138	25.400	25.27
1 1/8"	7	3.629	28.296	28.575	28.44
1 1/4"	7	3.629	31.465	31.750	31.61
1 1/2"	6	4.233	37.793	38.100	37.95
1 3/4"	5	5.080	44.117	44.450	44.28
2"	4.5	5.644	50.449	50.800	50.62
2 1/4"	4	6.350	56.779	57.150	56.96
2 1/2"	4	6.350	63.119	63.500	63.31

UNS ANSI B1.1, 2A

Ø	P	P	Наружный диаметр резьбы		
			Średnica zewnętrzna		
d _i	TPI	mm	Ø mini	Ø maxi	Ø guide line
10	36	0.706	4.664	4.803	4.73
10	40	0.635	4.674	4.803	4.74
10	56	0.454	4.705	4.808	4.76
1/4"	36	0.706	6.188	6.327	6.26
1/4"	40	0.635	6.198	6.327	6.26
1/4"	48	0.529	6.216	6.329	6.27
1/4"	56	0.454	6.226	6.329	6.28
5/16"	36	0.706	7.775	7.914	7.84
3/8"	36	0.706	9.360	9.499	9.43
7/16"	24	1.058	10.902	11.084	10.99
1/2"	24	1.058	12.487	12.669	12.58
1"	14	1.814	25.096	25.356	25.23

PG DIN 40430

Ø	P	P	Наружный диаметр резьбы		
			Średnica zewnętrzna		
d _i	TPI	mm	Ø mini	Ø maxi	Ø guide line
7	20	1.270	12.3	12.5	12.40
9	18	1.411	15.0	15.2	15.10
11	18	1.411	18.4	18.6	18.50
13.5	18	1.411	20.2	20.4	20.30
16	18	1.411	22.3	22.5	22.40
21	16	1.588	28.0	28.3	28.15
29	16	1.588	36.7	37.0	36.85
36	16	1.588	46.7	47.0	46.85
42	16	1.588	53.7	54.0	53.85
48	16	1.588	59.0	59.3	59.15

G (BSP) DIN ISO 228

Ø	P	P	Наружный диаметр резьбы		
			Średnica zewnętrzna		
d _i	TPI	mm	Ø mini	Ø maxi	Ø guide line
1/16"	28	0.907	7.509	7.723	7.62
1/8"	28	0.907	9.514	9.728	9.62
1/4"	19	1.337	12.907	13.157	13.03
3/8"	19	1.337	16.412	16.662	16.54
1/2"	14	1.814	20.671	20.955	20.81
5/8"	14	1.814	22.627	22.911	22.77
3/4"	14	1.814	26.157	26.441	26.30
7/8"	14	1.814	29.917	30.201	30.06
1"	11	2.309	32.889	33.249	33.07
1 1/8"	11	2.309	37.537	37.897	37.72
1 1/4"	11	2.309	41.550	40.910	41.73
1 3/8"	11	2.309	43.963	44.323	44.14
1 1/2"	11	2.309	47.443	47.803	47.62
1 3/4"	11	2.309	53.386	53.746	53.57
2"	11	2.309	59.254	59.614	59.43
2 1/4"	11	2.309	65.276	65.710	65.49
2 1/2"	11	2.309	74.750	75.184	74.97
2 3/4"	11	2.309	81.100	81.534	81.32
3"	11	2.309	87.450	87.884	87.67
3 1/2"	11	2.309	99.896	100.330	100.11

TR ISO 2901-2904, DIN 103, 7e

Ø	P	Наружный диаметр резьбы		
		Średnica zewnętrzna		
d _i	mm	Ø mini	Ø maxi	Ø guide line
10	2	9.820	10.000	9.91
12	3	11.764	12.000	11.88
14	3	13.764	14.000	13.88
16	4	15.700	16.000	15.85
18	4	17.700	18.000	17.85
20	4	19.700	20.000	19.85
22	5	21.665	22.000	21.83
24	5	23.665	24.000	23.83
26	5	25.665	26.000	25.83
28	5	27.665	28.000	27.83
30	6	29.625	30.000	29.81
32	6	31.625	32.000	31.81



Zapytanie <input type="checkbox"/>	Wyniki testów <input type="checkbox"/>	Reklamacja <input type="checkbox"/>
Dystrybutor : _____ Klient : _____ Telefon lub faks: _____		Kontakt : _____ E-mail : _____ Data : _____
1. Typ narzędzia : _____ Szczególny : _____		Wielkość gwintu : _____ Tolerancja wykonania : _____
2. Grupa materiałowa : _____ Materiał nr. : _____ Norma : _____		Twardość : _____ N/mm ² /HB/HRC Wydłużenie : _____ %
3. Gwint : <input type="checkbox"/> Otwór ślepy <input type="checkbox"/> Otwór przelotowy Średnica otworu : _____ Głębokość : _____ mm Średnica nawiercenia : _____ Głębokość : _____ mm		Długość gwintu : _____ mm
4. Prędkość skrawania(V_c) : _____ m/min Posuw (f) : _____ %		_____ 1/min
5. Obrabiarka : _____ Układ pracy : <input type="checkbox"/> układ poziomy <input type="checkbox"/> układ pionowy Gwintowanie na sztywno : <input type="checkbox"/> „Miękkie gwintowanie na sztywno” <input type="checkbox"/> Tulejka <input type="checkbox"/> Weldon <input type="checkbox"/> Mocowanie termiczne		<input type="checkbox"/> Chłodzenie wewnętrzne Wrzeczono gwintujące : <input type="checkbox"/> Kompensacja osiowa <input type="checkbox"/> Wysprężnianie <input type="checkbox"/> Rewersyjny <input type="checkbox"/> Sprzęgło ślizgowe
6. Chłodziwo : <input type="checkbox"/> Emulsja <input type="checkbox"/> Olej Produkt : _____		<input type="checkbox"/> Powietrze <input type="checkbox"/> Mgła olejowa
7. Powód zmiany narzędzia : <input type="checkbox"/> Zużycie narzędzia <input type="checkbox"/> Gwint wykonany nieprawidłowo (sprawdzony sprawdzianem) <input type="checkbox"/> Błąd obrabiarki		<input type="checkbox"/> Zniszczenie narzędzia <input type="checkbox"/> Wyłamanie zębów w zwojach wprowadzających <input type="checkbox"/> Wyłamanie zębów w zwojach nacinających
8. Porównanie wydajności Narzędzie w trakcie testów : _____ Wyniki i obserwacje : _____		
Uwagi : _____ _____		

Запрос <input type="checkbox"/>	Результат испытаний <input type="checkbox"/>	Претензии <input type="checkbox"/>
Агент : _____		Контактное лицо : _____
Потребитель : _____		E-Mail : _____
Телефон или факс: _____		Дата : _____
<hr/>		
1. Тип инструмента : _____		
Диаметр инструмента : _____		Шаг резьбы : _____
Серия : _____		Покрытие : _____
<hr/>		
2. Группа материалов : _____		
№ материала : _____		Тведость : _____ N/mm ² /HB/HRC
Стандарт : _____		Удлинение : _____ %
<hr/>		
3. Резьба : <input type="checkbox"/> Внутренняя <input type="checkbox"/> Внешняя		
Отверстие : <input type="checkbox"/> Глухое <input type="checkbox"/> Сквозное		
Длина нарезаемой резьбы : _____ mm		
Диаметр отверстия под резьбу : _____		Глубина : _____ mm
Диаметр зенкера : _____		Глубина : _____ mm
<hr/>		
4. Скорость резания : _____ m/min _____ 1/min		
Подача (f) : _____ %		Подача (f _z) : _____ (мм/зуб)
<hr/>		
5. Станок : _____ <input type="checkbox"/> Внутренняя подача СОЖ		
Рабочее положение : <input type="checkbox"/> Горизонтальное <input type="checkbox"/> Вертикальное		Крепление инструмента : <input type="checkbox"/> Цанга <input type="checkbox"/> Weldon / Whistle Notch <input type="checkbox"/> Гидравлический патрон <input type="checkbox"/> Скользящая муфта
<hr/>		
6. Смазка : <input type="checkbox"/> Эмульсия <input type="checkbox"/> Масло <input type="checkbox"/> Воздух <input type="checkbox"/> Аэрозоль		
Наименование : _____		
<hr/>		
7. Причина замены инструмента : <input type="checkbox"/> Износ инструмента <input type="checkbox"/> Поломка инструмента		
<input type="checkbox"/> Несоответствие резьбы калибру <input type="checkbox"/> Ошибка станка		
<hr/>		
8. Сравнение эффективности		
Испытываемый инструмент : _____		
Результаты и замечания : _____		

<hr/>		
Примечания : _____		

УСЛОВИЯ ПОСТАВКИ И ОПЛАТЫ

Заказы	По заказам, которые не могут быть отгружены немедленно, будут сообщены сроки поставки. На изделия, которые более не относятся к стандартной программе, но присутствуют в каталоге, цены будут указаны как на „специальные“. Заказ может быть аннулирован только совместным письменным соглашением.
Ценовые предложения и уведомления	По причине постоянного развития все характеристики, упомянутые в наших предложениях, приложениях, указаниях весов, измерений, также как и иллюстрации и чертежи указывают приближенные значения. Эти технические данные имеют обязательное значение только там, где оговорено дополнительно.
Цены	Наши цены указаны при условиях поставки ex works Malleray, без учета НДС, упаковки, страховки, фрахта, таможенных и регистрационных сборов. В случае роста цен, мы оставляем за собой право выставять счета по уже измененным ценам.
Платежи	Платежи должны производиться в форме аванса или в форме безотзывного подтвержденного аккредитива открытого в нашу пользу в Швейцарском банке. Все банковские комиссии и сборы должны быть уплачены покупателем.
Право собственности	Мы оставляем за собой право собственности на все поставляемые товары до тех пор, пока цена продажи плюс побочные расходы не будут нам полностью оплачены покупателем.
Отгрузка	Все риски, связанные с поставкой, относятся на счет покупателя.
Поставка	Подтвержденные сроки поставки не являются обязывающими. Мы сделаем все от нас зависящее, чтобы выдержать их. Однако мы не можем нести ответственности за прямые или косвенные потери, возникшие по причине задержки поставки.
Специальные заказы	При исполнении специальных заказов мы оставляем за собой право на количественные колебания изделий в пределах 15 %, или при небольших заказах 1 или 2 штуки.
Гарантии	Инструменты, признанные бракованными по вине DC будут заменены бесплатно, но без возмещения каких бы то ни было прочих убытков.
Претензии	Претензии принимаются в течение 15 дней с даты получения товара.
Чертежи и эскизы	Воспроизведение или передача чертежей и прочих документов третьим сторонам запрещены. Информация (чертежи и иллюстрации) в нашем каталоге являются информационными но не обязательными.
Специальные условия	В случае частичной или полной остановки нашего производства мы оставляем за собой право частично или полностью отказаться от обязательств по поставке.
Арбитраж	Все споры разрешаются в соответствии со Швейцарским законодательством. Местонахождение арбитражного суда – Мотье (Moutier), Швейцария.

DOSTAWA I WARUNKI PŁATNOŚCI DC SWISS

Zamówienia	Zamówienia, które nie mogą być zrealizowane z magazynu będą potwierdzone. Narzędzia, które nie należą już do programu standardowego, mimo że nadal występują w katalogu, będą fakturowane jako „specjalne”. Zamówienia mogą zostać anulowane na podstawie wzajemnych pisemnych ustaleń.
Oferty i potwierdzenia	Ze względu na ciągły rozwój, wszelkie informacje zawarte w ofertach (opisy, załączniki, wymiary, wagi oraz rysunki) są przybliżone. Tego typu dane techniczne można traktować jako wiążące tylko wówczas, gdy zostały jasno sprecyzowane.
Ceny	Oferowane przez nas ceny dotyczą dostaw „ex works” Malleray i nie zawierają podatku VAT, pakowania, ubezpieczenia, kosztów przesyłki oraz odpraw celnych. W przypadku wzrostu cen, zastrzegamy sobie prawo do fakturowania narzędzi już potwierdzonych zgodnie z nowym cennikiem.
Płatność	Płatności muszą być dokonane z góry lub na podstawie nieodwołalnej i potwierdzonej akredytywy dokumentowej, otwartej na naszą korzyść w banku Swiss. Wszystkie opłaty bankowe ponosi kupujący.
Prawo własności	Zastrzegamy sobie prawo własności w stosunku do wszystkich dostarczonych towarów do momentu dokonania pełnej płatności z uwzględnieniem wszelkich kosztów dodatkowych.
Przesyłka	Przesyłki są dokonywane na ryzyko nabywcy.
Dostawa	Potwierdzone terminy dostaw nie są wiążące. Zrobimy wszystko co w naszej mocy, aby je utrzymać. Jednakże nie ponosimy odpowiedzialności za ewentualne straty wynikłe bezpośrednio lub pośrednio z powodu opóźnionych dostaw.
Zamówienia specjalne	Dla wszystkich narzędzi specjalnych zastrzegamy sobie prawo do dostaw pomniejszonych lub powiększonych o 15% w stosunku do zamówionej ilości (w przypadku małych ilości o 1 lub 2 szt.).
Gwarancja	Narzędzia uznane przez DC za wadliwe będą wymienione bezpłatnie lecz bez wcześniejszego powiadomienia.
Reklamacje	Reklamacje będą rozpatrzone w ciągu 15 dni od daty dostarczenia wadliwego towaru.
Rysunki i szkice	Kopiowanie lub przekazywanie rysunków i dokumentów osobom trzecim jest zabronione. Informacje (rysunki i wydruki) zamieszczone w katalogu mają charakter pomocniczy i nie są wiążące.
Warunki specjalne	W przypadku częściowego lub całkowitego wstrzymania procesu produkcyjnego, zastrzegamy sobie prawo do częściowego lub całkowitego anulowania zobowiązań wynikających ze złożonych zamówień.
Regulacje prawne	Powyższe kwestie są regulowane przez prawo szwajcarskie z siedzibą sądu w Moutier (Szwajcaria).

ЦЕНОВЫЕ ДОПОЛНЕНИЯ – DODATKOWE OPŁATY

Изменения цен при модификациях и дополнительной обработке поверхности

	К цене за штуку брутто	К прайс-листу каждый типоразмер (нетто)
Изменение угла заточки (Ø 5 - 20 мм)	10 %	по запросу
Удлинение заходной части (до Ø 20 мм)	10 %	по запросу
Укорачивание заходной части (Ø 3 - 20 мм)	20 %	по запросу
Вышлифовка стружколомающей фаски (Ø 5 - 20 мм)	10 %	по запросу
Удаление центрального конуса	3 %	по запросу
Увеличенное стружечное пространство от Ø 4 мм	12 %	по запросу
Плазменное азотирование +»V« обработка поверхности	10 %	по запросу
DC „V“ обработка поверхности	8 %	по запросу
Дополнительная маркировка	5 %	по запросу
Внутренний СОЖ, фронтальный выход	по запросу	по запросу
Внутренний СОЖ, радиальный выход	по запросу	по запросу
Покрывтия TiN, TiCN, VS, CrN, HL	по запросу	по запросу

Dodatkowe opłaty za modyfikacje oraz obróbkę powierzchni

	Do każdej ceny brutto	Partycypacja w kosztach ustawczych wg typu i rozmiaru (netto)
Modyfikacja kąta natarcia (Ø 5 - 20 mm)	10 %	na życzenie
Wydłużenie nakroju (do Ø 20 mm)	10 %	na życzenie
Skrócenie nakroju (Ø 3 - 20 mm)	20 %	na życzenie
Ostrzenie narzynki (Ø 5 - 20 mm)	10 %	na życzenie
Usuwanie przeciwnakiełka	3 %	na życzenie
Nakrój obniżony od Ø 4 mm	12 %	na życzenie
Azotowany + waporyzowany	10 %	na życzenie
DC „V“ – waporyzacja	8 %	na życzenie
Dodatkowe cechowanie	5 %	na życzenie
Wew. chłodzenie, wyjście centralne	na życzenie	na życzenie
Wew. chłodzenie, wyjście promieniowe	na życzenie	na życzenie
Powłoki TiN, TiCN, VS, CrN, HL	na życzenie	na życzenie

Цены на поверочные сертификаты резьбовых калибров – Ceny za certyfikaty sprawdzianów

На вновь заказанные резьбовые калибры / Pogrešność измерений U95

Dla nowo zamówionych sprawdzianów / Błąd pomiaru wynosi U95

			Цены нетто / Ceny netto
D5703	D5725	Ø 1 - 2.9 mm Ø 3 - 40 mm	по запросу / на życzenie по запросу / на życzenie
D5701-1	D5701-2	Ø 1 - 2.9 mm Ø 3 - 40 mm Ø 41 - 80 mm Ø 81 - 200 mm	по запросу / на życzenie по запросу / на życzenie по запросу / на życzenie по запросу / на życzenie
D5704	D5714	Ø 1 - 2.9 mm Ø 3 - 40 mm Ø 41 - 80 mm Ø 81 - 200 mm	по запросу / на życzenie по запросу / на życzenie по запросу / на życzenie по запросу / на życzenie
D5720 / D5721	D5722 / D5723	Ø 3 - 40 mm Ø 41 - 80 mm Ø > 80 mm	по запросу / на życzenie по запросу / на życzenie по запросу / на życzenie

Все „сертифицированные“ калибры будут маркированы идентификационным номером соответствующего сертификата.

Wszystkie „certyfikowane“ sprawdziany będą cechowane numerem identyfikacyjnym odpowiadającym certyfikatowi.

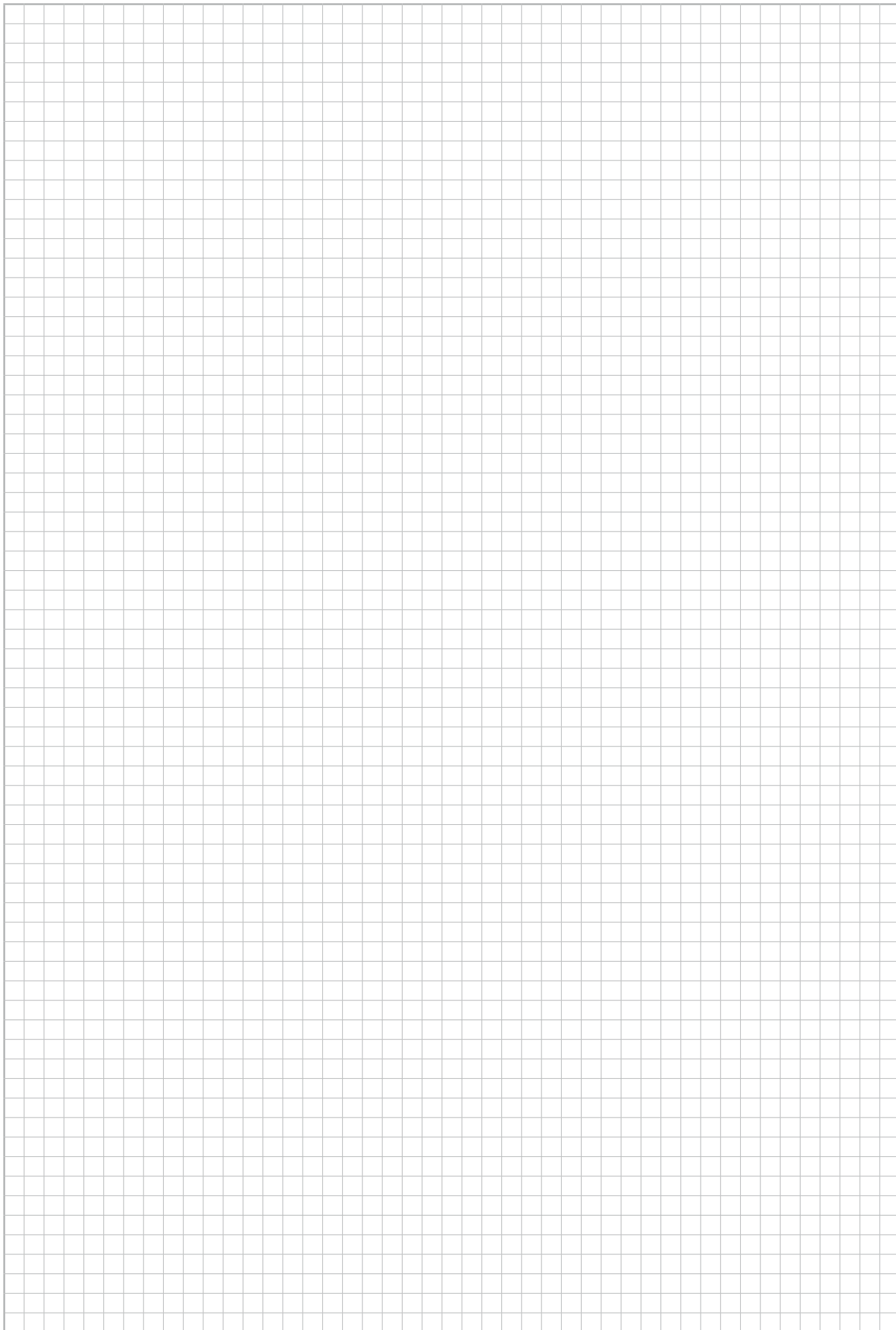



DC SWISS SA

CH-2735 Malleray

Tel. +41 32 491 63 63

Fax +41 32 491 64 64

E-mail: info@dcswiss.ch

DC SWISS GmbH

Graseggerstraße 125
DE-50737 Köln
Tel. +49 221 995 532-0
Fax +49 221 995 532-10
E-Mail: info@dcswiss.de

DC SWISS s.r.l.

Via Canova 10
IT-20017 Rho
Tel. +39 02 669 40 41
Fax +39 02 669 78 50
E-mail: info@dcswiss.it

DC SWISS UK Ltd

9 Orgreave Road
UK-Sheffield S13 9LQ
Tel. +44 114 2939013
Fax +44 114 2880936
E-mail: info@dcswiss.co.uk

Предупреждение

Резьбонарезные инструменты могут сломаться как по причине технического характера, так и допущенной небрежности и причинить вред здоровью оператора. Всегда соблюдайте правила техники безопасности, использование очков является обязательным. Заточка инструмента образует вредные частицы, поэтому должна выполняться только в соответствии с жесткими стандартами техники безопасности.

Uwaga

Narzędzia do gwintowania mogą pękać lub ulegać zniszczeniu zarówno w wyniku usterek technicznych, jak i poprzez zaniedbania, co w efekcie może narazić na niebezpieczeństwo zdrowie operatora. Szlifowanie narzędzi do gwintowania musi być wykonywane z zachowaniem najwyższych norm bezpieczeństwa.

Мы сделали все возможное для того чтобы содержащаяся информация (чертежи, рисунки, технические данные) были верными. Однако мы не несем ответственности за допущенные ошибки и опечатки. Воспроизведение чертежей и других документов, а также их передача третьим сторонам запрещены.

Dołożyliśmy wszelkich starań aby zapewnić, że podane informacje (rysunki, wydruki, dane techniczne) są prawidłowe. Jednakże nie bierzemy odpowiedzialności za jakiegokolwiek błędy, pominięcia lub potencjalne zmiany. Kopiowanie rysunków oraz innych dokumentów i przekazywanie ich osobom trzecim jest zabronione.

